

PAL/NTSC ONE-CHIP DECODER

- CHROMINANCE SIGNAL PROCESSOR
- LUMINANCE SIGNAL PROCESSING WITH CLAMPING
- HORIZONTAL AND VERTICAL BLANKING
- LINEAR TRANSMISSION OF INSERTED RGB SIGNALS
- LINEAR CONTRAST AND BRIGHTNESS CONTROL ACTING ON INSERTED AND MATRIXED SIGNALS
- AUTOMATIC CUT-OFF CONTROL
- NTSC HUE CONTROL

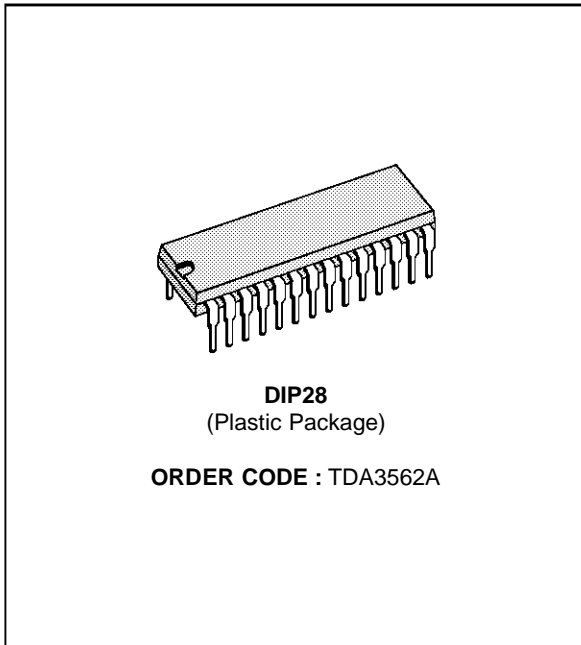

DESCRIPTION

The TDA3562A is a monolithic IC designed as decode PAL and/or NTSC colour television standards and it combines all functions required for the identification and demodulation of PAL and NTSC signals.

PIN CONNECTIONS

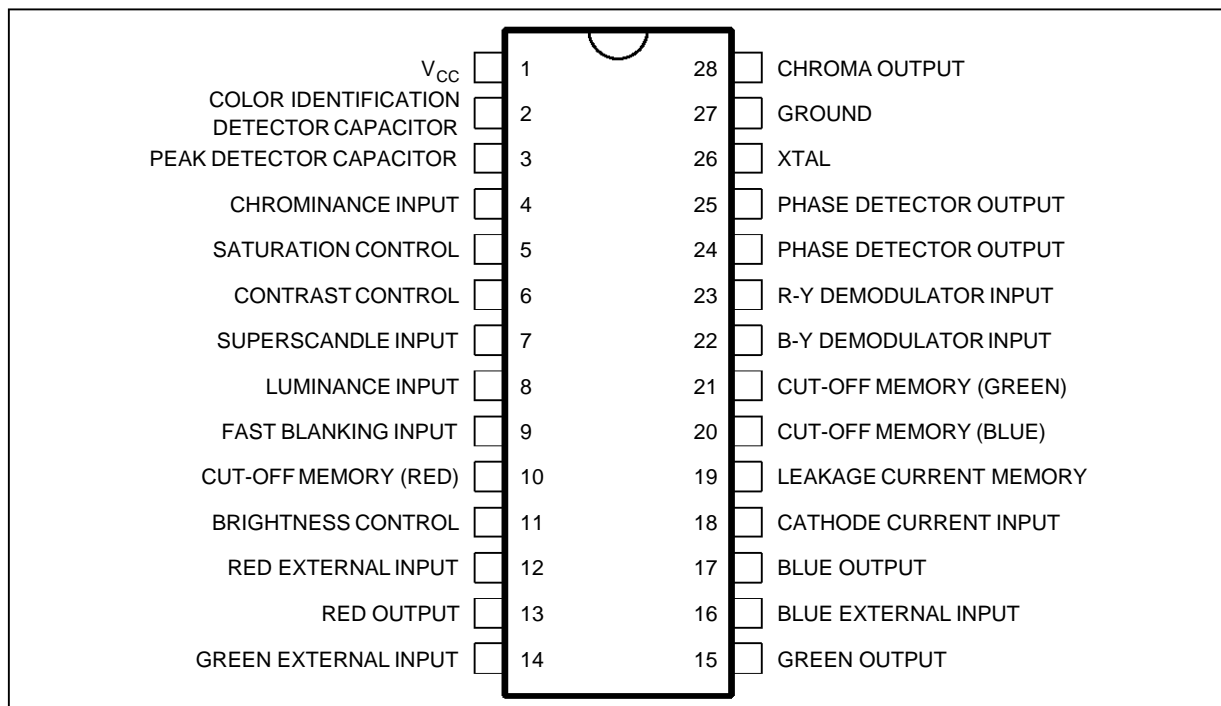

3562A-01.EPS

BLOCK DIAGRAM

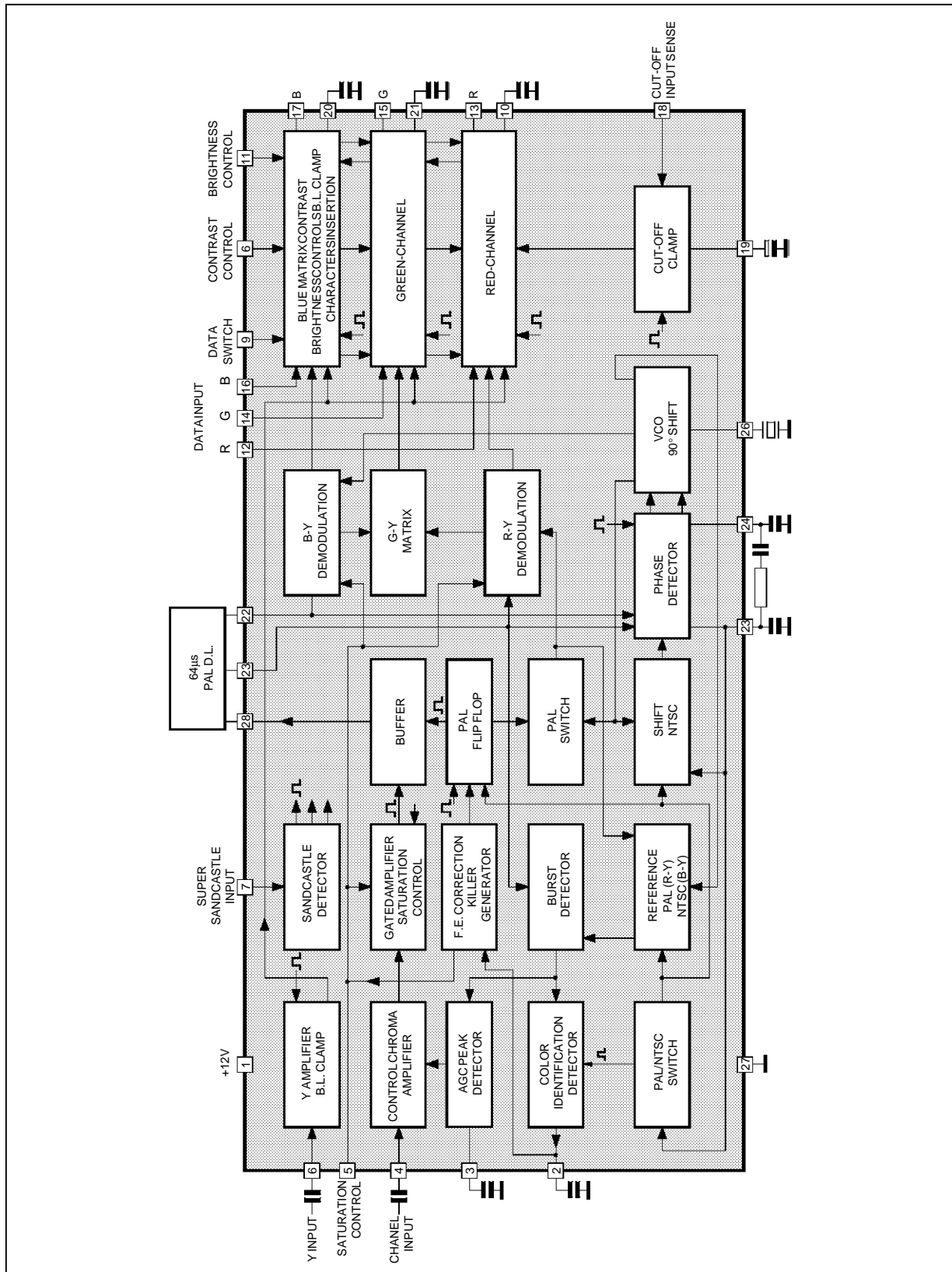

3562A-02.EPS

ABSOLUTE MAXIMUM RATINGS

Symbol	Parameter	Value	Unit
V_S	Supply Voltage	13.2	V
P_{tot}	Power Dissipation at $T_{amb} = 65\text{ }^\circ\text{C}$	1.7	W
T_{stg}, T_j	Storage and Junction Temperature	- 25, +150	$^\circ\text{C}$
T_{amb}	Ambient Temperature Range	0, +70	$^\circ\text{C}$

3562A-01.TBL

THERMAL DATA

Symbol	Parameter	Value	Unit
$R_{th\ j-amb}$	Thermal Resistance Junction-ambient	Max 40	$^\circ\text{C/W}$

3562A-02.TBL

ELECTRICAL CHARACTERISTICS

Test conditions unless otherwise specified : Supply voltage, Pin 1 at 12 V - $T_{amb} = 25\text{ }^\circ\text{C}$

Input signals : Luminance input signal $V_8 = 0.48 V_{PP}$ (Composite video signal (100 % white)
 Chrominance input signal $V_4 = 0.39 V_{PP}$ (Colour bar signal with 75 % colour saturation
 and chrominance to burst ratio = 2.2 : 1)

Data input signals $V_{12, 14, 16} = 1.4 V_{PP}$ (Including neg.going sync. pulse)

Control inputs at nominal value : Pin 6 Nom. contrast = max. contrast - 5dB
 Pin 5 Nom. saturation = max. saturation - 6 dB
 Pin 11 Nom. brightness = 2V, Pin 9 at 0.4 V

Symbol	Parameter	Test Conditions	Min.	Typ.	Max.	Unit
--------	-----------	-----------------	------	------	------	------

SUPPLY INPUT (pin 1)

	Supply Voltage Range		10.8		13.2	V
	Supply Current	$V_1 = 12\text{ V}$		80	110	mA

LUMINANCE INPUT (pin 8)

	Composite Input Signal				0.8	V_{pp}
	Input Current			0.1	1	μA

CHROMINANCE INPUT (pin 4)

	Input Signal		40		1100	mV_{PP}
	Input Resistance			10		$\text{K}\Omega$
	Input Capacitance				6.5	pF

SUPER SANDCASTLE INPUT (pin 7)

	Gating & Clamping Level		7.5			V
	H-pulse Separating Level		4		5	V
	V-pulse Separating Level		2		3	V
	Forbidden Range			1 to 2		V
	Input Current	$V_7 = 0\text{ to }1\text{ V}$ $V_7 = 1\text{ to }8.5\text{ V}$ $V_7 = 8.5\text{ to }12\text{ V}$		50	- 460 2	μA μA mA
	Delay Between Black Level Clamping Pulse and Gating Pulse			0.6		μs

DATA BLANKING INPUT (pin 9)

	Input Voltage for no Data Insertion				0.4	V
	Input Voltage for Data Insertion		0.9		3	V
	Input Resistance		7		13	$\text{k}\Omega$

"BLACK CURRENT" STABILIZATION INPUT (pin 18)

	D. C. Bias Voltage		3.5	5	7	V
	Internal Limiting Threshold			9		V
	Switching Threshold for "Black Current" ON			8		V

3562A-03.TBL

ELECTRICAL CHARACTERISTICS (continued)

Symbol	Parameter	Test Conditions	Min.	Typ.	Max.	Unit
"BLACK CURRENT" STABILIZATION INPUT (pin 18) (continued)						
	Difference between Input Voltage for "BlackCurrent" and Leakage Current			0.5		V
	Input Resistance during Scan			1.5		kΩ
	Input Current during "Black Current" Measurement				2	μA
	Input Current during Scan				10	mA

RGB - OUTPUTS (Pins 13, 15, 17)

	Output Resistance			50		Ω
	Current Source		2	3		mA
	Peak Output Level		10.7		11.3	V
	Residual 4.4 MHz at RGB Outputs				100	mVpp
	Residual 8.8 MHz at RGB Outputs				150	mVpp

LUMINANCE CHANNEL

	Frequency Resp. of Total Lumin. Amplifiers	f = 0 to 5MHz		-1	-3	dB
	RGB Output Signal (black to white)		3.5	4	4.5	Vpp
	Relative Spread of RGB - Output Signals				1	dB
	Contrast Control Range	(see fig. 1)		-5 to 10		dB
	Tracking Over 10 dB Contrast Control			0		dB
	Contrast Control Input Current				15	μA
	Blanking Level of RGB - Output Signals			1	1.2	V
	Difference Between Blanking Levels,		0		mV	
	Differential Drift of Blanking Levels	ΔT = 40 °C		0		mV
	Brightness Control Input Current				5	μA
	Brightness Control Range	(see fig. 3)		1 to 3		V
	Relation Ship between Black Level Variation and Brightness Control Variation	(see fig. 3)		1.3		V/V
	Black Level of RGB Output Signals	(see note 4)		3		V
	Difference between Black Levels	(see note 4)		0		mV
	Tracking Over Brightness Control				2	%
	Differential Drift of Black Levels	ΔT = 40 °C			20	mV
	Drift of Black Level Versus 10 % Variation of Supply Voltage and Contrast Control				20	mV

"CUT OFF CURRENT" REGULATION

	RGB Output Level of the "3L Windows" after Switch-on		7.5			V
	RGB Outputs Level of the "3L Windows" after Cut off Current Stabilization	(see note 4)	1	3	5	V
	RGB Output Range		1		5	V
	Charge/Discharge Current during Measuring Time (3L windows) at Pins 10, 19, 20 and 21			1		mA
	Leakage Currents Flowing into Pins 10, 20 and 21 during Scan				50	nA

RGB DATA INSERTION

	Data RGB Output Signal	V ₉ = 0.9 to 3V		4		Vpp
	Differential Amplitude Error between RGB Output Signal and Data Output Signal				10	%
	Differential Error between Black Levels of RGB Output Signals and Black Levels of Data Output Signals				200	mV

3562A-04-TBL

ELECTRICAL CHARACTERISTICS (continued)

Symbol	Parameter	Test Conditions	Min.	Typ.	Max.	Unit
RGB DATA INSERTION (continued)						
	Rise Time of Data Output Signal			50	80	ns
	Differential Delay			0	40	ns
	Attenuation of RGB Output Signal	$V_9 = 0.9$ to 3 V		46		dB
	Frequency Response for $f = 0$ to 5 MHz			- 1	- 3	dB

CHROMINANCE CHANNEL

Pin 4	Chrominance Input Signal		40		1100	mVpp
Pin 4	Input Resistance			10		k Ω
Pin 4	Input Capacitance				6.5	pF
	ACC Control Range		30			dB
Pin 28	Burst Change Over 30 dB ACC Range				1	dB
	Saturation Control Range	(see fig. 2)		- 44 to 6		dB
Pin 5	Sat. Control Input Current				20	μ A
Pin 28	Chrominance Output Voltage	$V_5 = 4.2$ V	4			Vpp
	Burst Input Signal at Pins 22 and 23			100		mVpp
	Input Resist. Bet. Pins 22, 23 and Ground			1		k Ω
Pin 28	Phase Shift Bet. Burst and Chrom. Signal		- 5	0	5	$^\circ$
Pin 2	Voltage at Nom. Input Signal			4.7		V
Pin 2	Voltage without Input Signal			2.6		V
Pin 2	Identificaton-on Voltage			2.1		V
Pin 2	Colour-off Voltage			3.4		V
Pin 2	Colour-on Voltage			3.6		V
Pin 3	Voltage at Nom. Input Signal			5.1		V

COLOUR DEMODULATORS AND G-Y MATRIX

	Ratio (B-Y) / (R-Y)		1.60	1.78	1.96	
	Ratio (G-Y) / (R-Y)	(B - Y) = 0	- 0.46	- 0.51	- 0.56	
	Ratio (G-Y) / (B-Y)	(R - Y) = 0	- 0.14	- 0.19	- 0.24	

REFERENCE OSCILLATOR

	Oscillator Frequency			2 fcs		MHz
	Temp. Coefficient of Oscillator Frequency	(see note 5)		- 2		Hz/k
Pin 26	Input Resistance			400		Ω
Pin 26	Input Capacitance				10	pF
	Pull-in Range	(see note 5)	500	700		Hz
	Phase Shift for ± 400 Hz Deviation				5	$^\circ$ C
	Phase Shift between (R - Y) and (R - Y) Ref.Signal				5	$^\circ$ C
	Phase Shift between (R - Y) and (B - Y) Ref.Signal		85	90	95	$^\circ$ C

NTSC OPERATION

Pins 24, 25	PAL-on Operating Range		9		11	V
Pins 24, 25	Threshold for NTSC-on			8.8		V
$J_{24} + J_{25}$	Avarage Output Current	Key Pulse = 4μ s		90		μ A
	Hue Control		± 30			$^\circ$ C
Pins 24, 25	Hue Control Voltage		7.5		8.5	V

(4) The levels depend on the application circuit and on the spread and drift of picture tube guns.

(5) All frequency variations are referred to 4.4 MHz carrier frequency.

3562A-05.TBL

Figure 1 : Contrast Control Voltage Range

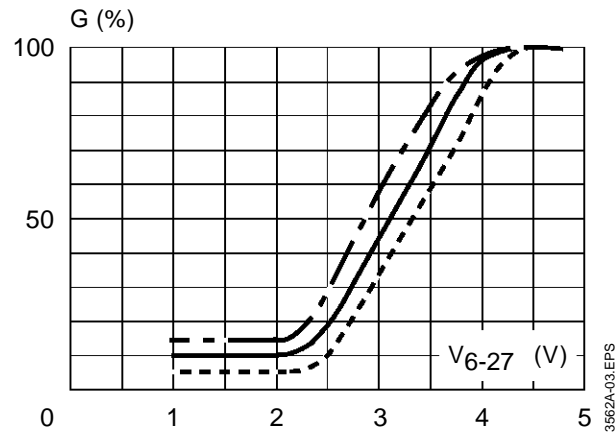

Figure 2 : Saturation Control Voltage Range

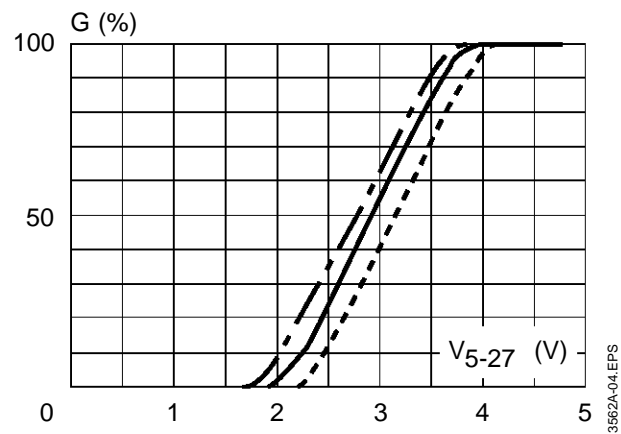

Figure 3 : Difference between signal black level and measuring level (3L windows after cut off current stabilization) at the RGB outputs (ΔV) versus control voltage ($V_{11} - V_{12}$).

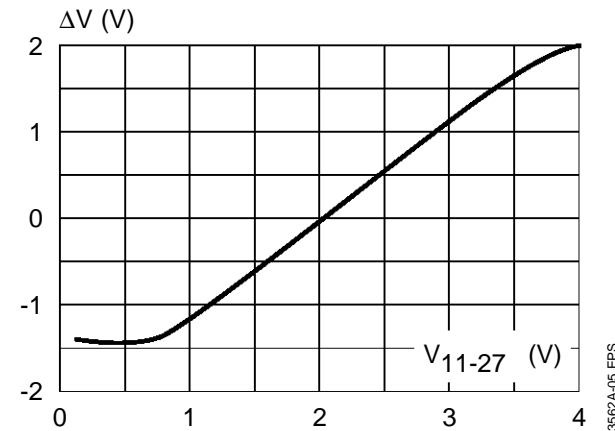
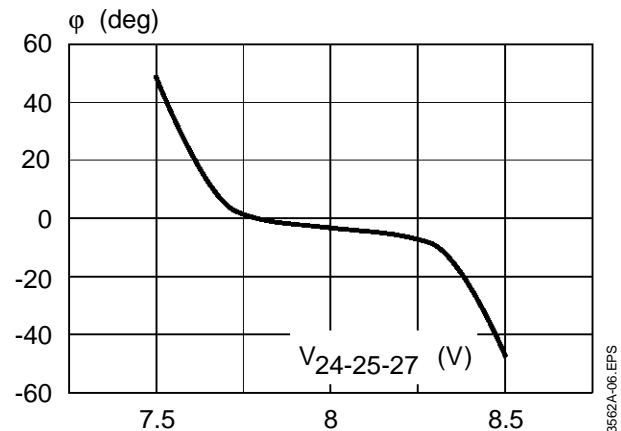
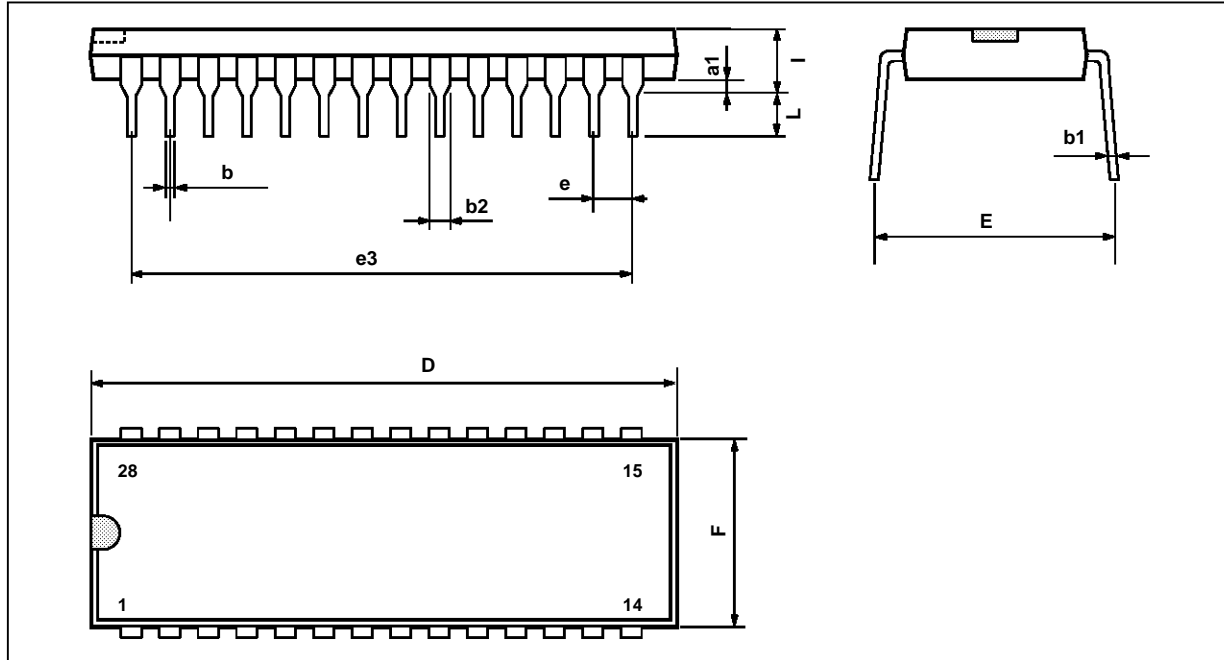

Figure 4 : Hue Control Voltage Range



PACKAGE MECHANICAL DATA

28 PINS - PLASTIC 28



PM-DIP28.EPS

Dimensions	Millimeters			Inches		
	Min.	Typ.	Max.	Min.	Typ.	Max.
a1		0.63			0.025	
b		0.45			0.018	
b1	0.23		0.31	0.009		0.012
b2		1.27			0.050	
D			37.4			1.470
E	15.2		16.68	0.598		0.657
e		2.54			0.100	
e3		33.02			1.300	
F			14.1			0.555
i		4.445			0.175	
L		3.3			0.130	

DIP28.TEL

Information furnished is believed to be accurate and reliable. However, SGS-THOMSON Microelectronics assumes no responsibility for the consequences of use of such information nor for any infringement of patents or other rights of third parties which may result from its use. No licence is granted by implication or otherwise under any patent or patent rights of SGS-THOMSON Microelectronics. Specifications mentioned in this publication are subject to change without notice. This publication supersedes and replaces all information previously supplied. SGS-THOMSON Microelectronics products are not authorized for use as critical components in life support devices or systems without express written approval of SGS-THOMSON Microelectronics.

© 1994 SGS-THOMSON Microelectronics - All Rights Reserved

Purchase of I²C Components of SGS-THOMSON Microelectronics, conveys a license under the Philips I²C Patent. Rights to use these components in a I²C system, is granted provided that the system conforms to the I²C Standard Specifications as defined by Philips.

SGS-THOMSON Microelectronics GROUP OF COMPANIES

Australia - Brazil - China - France - Germany - Hong Kong - Italy - Japan - Korea - Malaysia - Malta - Morocco
The Netherlands - Singapore - Spain - Sweden - Switzerland - Taiwan - Thailand - United Kingdom - U.S.A.