

AN7174K

Dual BTL 14W Audio Power Amplifier Circuit

■ Overview

The AN7174K is an integrated circuit for 14W (13.2V, 4Ω) output power amplifier circuit. Two BTL amplifiers are built-in on a single chip and stereo operation is possible. It is highly reliable due to protection circuits built-in. The built-in stand-by circuit makes it possible to switch the circuit ON/OFF with a charge mode to power supply pin.

■ Features

- High output power (BTL 14W × 2)
- Stand-by circuit built-in
- Protection circuits built-in (temperature, overvoltage, V_{OUT} -GND short, Load short, V_{OUT} - V_{CC} short)
- Low shock noise from power ON/OFF operation
- Fewer external parts
- Highly stable operation

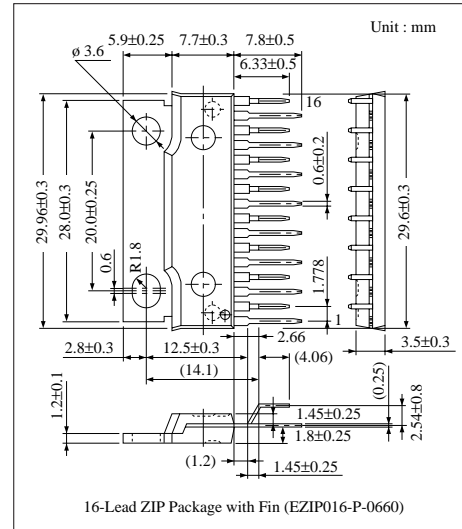

■ Block Diagram

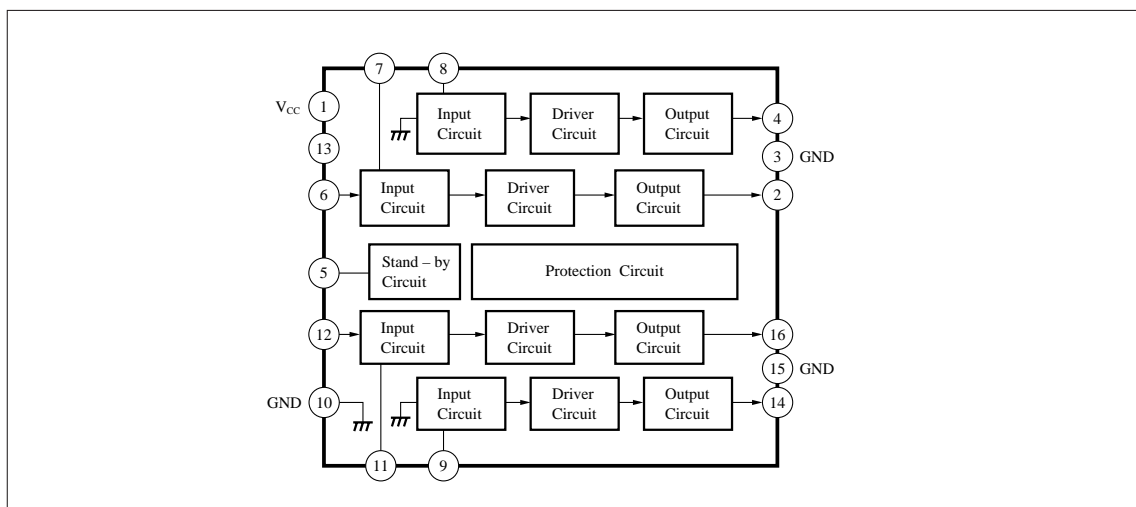

■ Absolute Maximum Ratings (Ta= 25°C)

Parameter	Symbol	Rating	Unit
Supply Voltage ^{Note 1)}	V _{CC}	24	V
Peak Supply Voltage ^{Note 2)}	V _{CC(surge)}	50	V
Supply Current	I _{CC}	6	A
Power Dissipation ^{Note 3)}	P _D	62.5	W
Operating Ambient Temperature	T _{opr}	- 30 ~ + 75	°C
Storage Temperature	T _{stg}	- 55 ~ + 150	°C

Note 1) No Signal

Note 2) Time= 0.2s

Note 3) R_{θj-c} = 2°C/W

■ Recommended Operating Range (Ta = 25°C)

Parameter	Symbol	Range
Operating Supply Voltage Range	V _{CC}	8V ~ 18V

■ Electrical Characteristics (V_{CC} = 13.2V, R_L = 4Ω, f = 1kHz, Ta = 25°C)

Parameter	Symbol	Condition	min.	typ.	max.	Unit
Quiescent Circuit Current	I _{CQ}	V _{in} = 0mV	—	120	200	mA
Output Noise Voltage	V _{no} *	V _{in} = 0mV, R _g = 10kΩ	—	0.6	1.5	mV
Voltage Gain	G _V	V _{in} = 5mV	50.5	52.5	54.5	dB
Total Harmonic Distortion	THD	V _{in} = 5mV	—	0.2	0.75	%
Maximum Output Power (4Ω)	P _O	THD = 10%	9	12.5	—	W
Ripple Rejection Ratio	RR *	R _g = 0Ω, V _{in} = 0mV, Ripple = 300mV, 120Hz	35	40	—	dB
Output Offset Voltage	V _{O(offset)}	V _{in} = 0mV	-300	0	300	mV
Channel Balance	CB	V _{in} = 5mV	-1	0	1	dB
Total Harmonic Distortion	THD	V _{in} = 5mV, 100Hz	—	0.26	—	%
Total Harmonic Distortion	THD	V _{in} = 5mV, 10kHz	—	0.45	—	%
Frequency Characteristics	f _{CH}	V _{in} = 5mV, -3dB down	—	22	—	kHz
Frequency Characteristics	f _{CL}	V _{in} = 5mV, -3dB down	—	21	—	Hz
Quiescent Circuit Current at Stand-by Pin	I _{CQ(STBY-ON)}	Stand-by Pin ON	—	21	—	μA
Crosstalk	CT	V _{in} = 5mV, R _g = 10kΩ	—	61	—	dB

* With 15Hz ~ 30kHz (12dB/oct) filter

■ Characteristics Curve

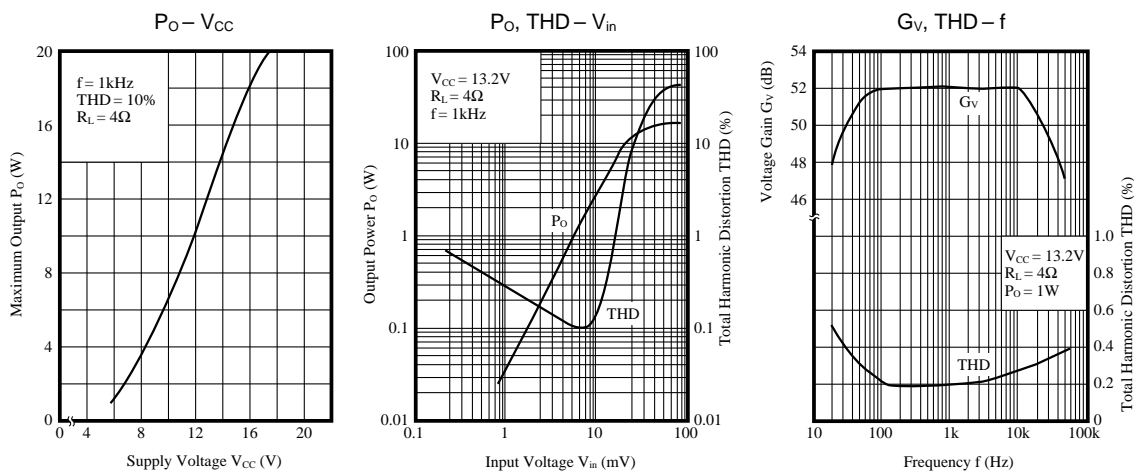

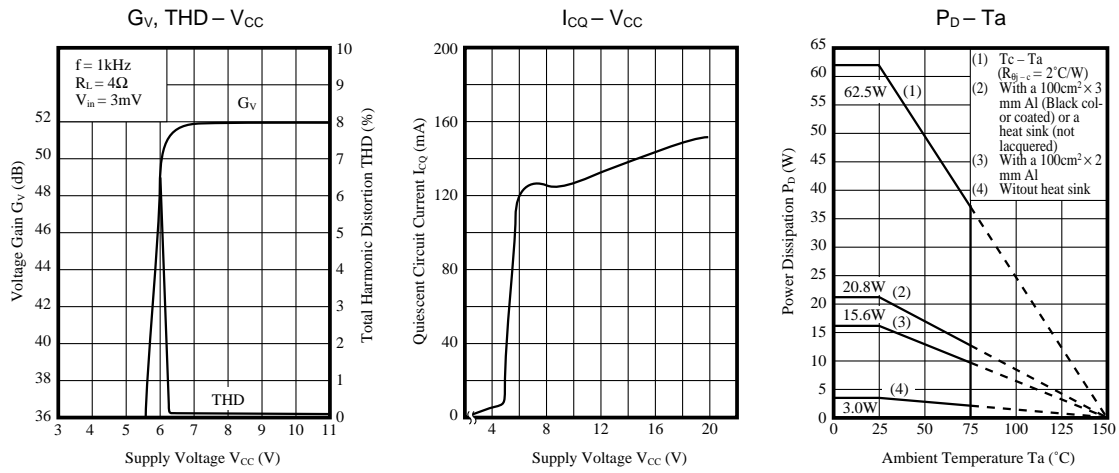

■ Application Circuit

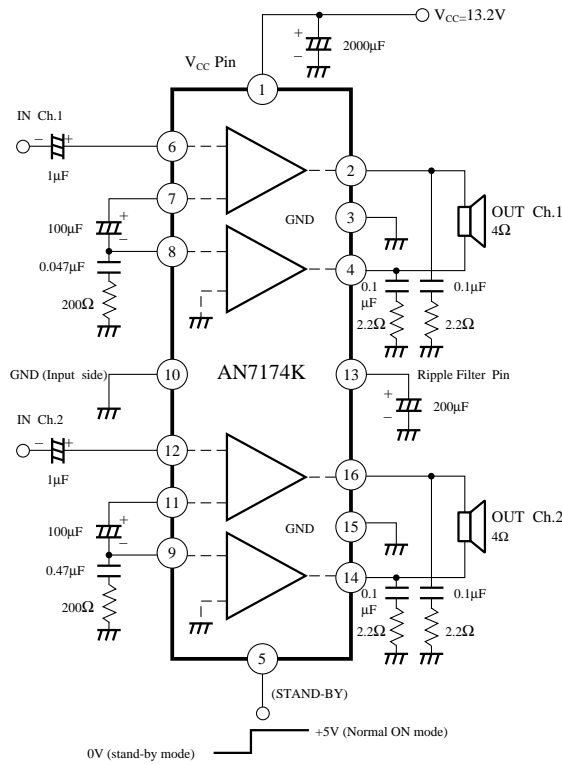

Note) 300mV, 120Hz ripple component should be applied at the measurement of ripple rejection ratio.

■ Pin Descriptions

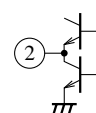
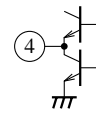
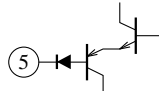
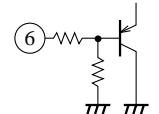
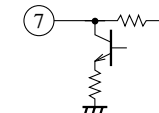
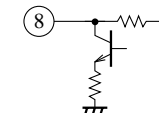
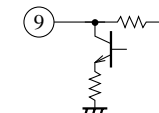
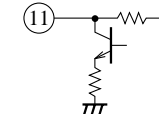
Pin No.	Pin Name	Description	Equivalent Circuit
1	Supply Pin	Supply connection pin	—————
2	Output Ch.1	Ch.1 positive-phase output pin	
3	GND (Output Ch.1)	GND pin for Ch.1 output	—————
4	Output Ch.1	Ch.1 reverse-phase output pin	
5	Stand-by	Circuit mode (stand-by ↔ operation) switching pin	
6	Input Ch.1	Ch.1 input signal applied pin	
7	Negative Feedback Ch.1	Ch.1 negative feedback pin (+)	
8	Negative Feedback Ch.1	Ch.1 negative feedback pin (-)	
9	Negative Feedback Ch.2	Ch.2 negative feedback pin (-)	
10	GND (Input)	GND pin for input signal source	—————
11	Negative Feedback Ch.2	Ch.2 negative feedback pin (+)	

■ Pin Descriptions (Cont.)

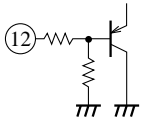
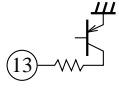
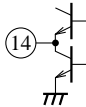
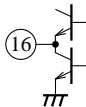
Pin No.	Pin Name	Description	Equivalent Circuit
12	Input Ch.2	Ch.2 input signal applied pin	
13	Ripple Filter	Supply ripple rejection pin	
14	Output Ch.2	Ch.2 reverse-phase output pin	
15	GND (Output Ch.2)	GND pin for Ch.2 output	—
16	Output Ch.2	Ch.2 positive-phase output pin	

■ Precautions on use

1. Thermal breaking protection
The protective operation starts at the chip temperature of $150^{\circ}\text{C}\pm 5^{\circ}\text{C}$.
2. Overvoltage protection
The protective operation starts at $V_{\text{CC}} - 26\text{V}$.
3. Ground fault protection
The protective operation starts when the contact resistance dropped below 0.3Ω .
4. Load shortcircuit protection
The protective operation starts when the contact resistance dropped below 0.3Ω .
5. Atmospheric fault protection
The protective operation starts only when a shortcircuit between pins occurred.
6. TAB shortcircuit
Even TAB short-circuiting with the GND potential causes no breaking trouble.
7. The operation remains normal even when the load is 2Ω .
8. When the chip temperature abnormally rose, the temperature protection circuit gets actuated, but it is automatically reset when the chip temperature dropped below the set level.



LittleDiode supplies new, hard to find or obsolete electronic components and semiconductors all over the world.

With over two million different components listed you are sure to find the part you need.

Feel free to visit us today at our online store:

LittleDiode.com

Looking forward to providing you with the best possible service.