

60MHz Rail-to-Rail Input-Output Op Amps



The EL5111, EL5211, and EL5411 are low power, high voltage rail-to-rail input-output amplifiers. The EL5111

represents a single amplifier, the EL5211 contains two amplifiers, and the EL5411 contains four amplifiers. Operating on supplies ranging from 5V to 15V, while consuming only 2.5mA per amplifier, the EL5111, EL5211, and EL5411 have a bandwidth of 60MHz (-3dB). They also provide common mode input ability beyond the supply rails, as well as rail-to-rail output capability. This enables these amplifiers to offer maximum dynamic range at any supply voltage.

The EL5111, EL5211, and EL5411 also feature fast slewing and settling times, as well as a high output drive capability of 65mA (sink and source). These features make these amplifiers ideal for high speed filtering and signal conditioning application. Other applications include battery power, portable devices, and anywhere low power consumption is important.

The EL5111 is available in 5-pin TSOT and 8-pin HMSOP packages. The EL5211 is available in 8-pin MSOP and 8-pin HMSOP packages. The EL5411 is available in space-saving 14-pin TSSOP and 14-pin HTSSOP packages. All feature a standard operational amplifier pinout. These amplifiers operate over a temperature range of -40°C to +85°C.

Features

- 60MHz -3dB bandwidth
- Supply voltage = 4.5V to 16.5V
- Low supply current (per amplifier) = 2.5mA
- High slew rate = 75V/ μ s
- Unity-gain stable
- Beyond the rails input capability
- Rail-to-rail output swing
- \pm 180mA output short current

Applications

- TFT-LCD panels
- V_{COM} amplifiers
- Drivers for A-to-D converters
- Data acquisition
- Video processing
- Audio processing
- Active filters
- Test equipment
- Battery-powered applications
- Portable equipment

Pinouts

EL5111
(8-PIN HMSOP)
TOP VIEW

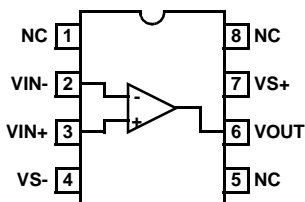

EL5111
(5-PIN TSOT)
TOP VIEW

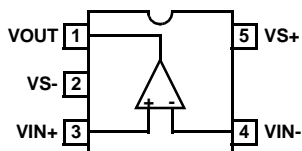

EL5211
(8-PIN MSOP, HMSOP)
TOP VIEW

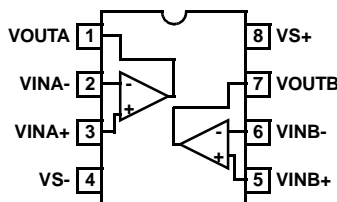

EL5411
(14-PIN TSSOP, HTSSOP)
TOP VIEW

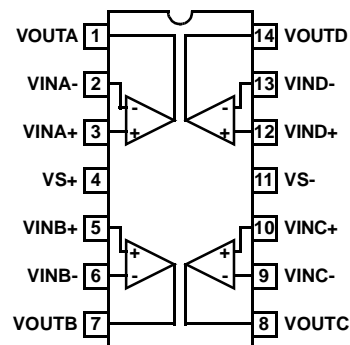

Ordering Information

| PART NUMBER | PACKAGE | TAPE & REEL | PKG. DWG. # |
|--------------------------|--------------------------|--------------|-------------|
| EL5111IWT-T7 | 5-Pin TSOT | 7" (3K pcs) | MDP0049 |
| EL5111IWT-T7A | 5-Pin TSOT | 7" (250 pcs) | MDP0049 |
| EL5111IWTZ-T7 (Note) | 5-Pin TSOT (Pb-Free) | 7" (3K pcs) | MDP0049 |
| EL5111IWTZ-T7A (Note) | 5-Pin TSOT (Pb-Free) | 7" (250 pcs) | MDP0049 |
| EL5111IYE | 8-Pin HMSOP | - | MDP0050 |
| EL5111IYE-T7 | 8-Pin HMSOP | 7" | MDP0050 |
| EL5111IYE-T13 | 8-Pin HMSOP | 13" | MDP0050 |
| EL5111IYEZ (Note) | 8-Pin HMSOP (Pb-Free) | - | MDP0050 |
| EL5111IYEZ-T7 (Note) | 8-Pin HMSOP (Pb-Free) | 7" | MDP0050 |
| EL5111IYEZ-T13 (Note) | 8-Pin HMSOP (Pb-Free) | 13" | MDP0050 |
| EL5211IY | 8-Pin MSOP | - | MDP0043 |
| EL5211IY-T7 | 8-Pin MSOP | 7" | MDP0043 |
| EL5211IY-T13 | 8-Pin MSOP | 13" | MDP0043 |
| EL5211IYZ (Note) | 8-Pin MSOP (Pb-Free) | - | MDP0043 |
| EL5211IYZ-T7 (Note) | 8-Pin MSOP (Pb-Free) | 7" | MDP0043 |
| EL5211IYZ-T13 (Note) | 8-Pin MSOP (Pb-Free) | 13" | MDP0043 |
| EL5211IYE | 8-Pin HMSOP | - | MDP0050 |

| PART NUMBER | PACKAGE | TAPE & REEL | PKG. DWG. # |
|--------------------------|----------------------------|-------------|-------------|
| EL5211IYE-T7 | 8-Pin HMSOP | 7" | MDP0050 |
| EL5211IYE-T13 | 8-Pin HMSOP | 13" | MDP0050 |
| EL5211IYEZ (Note) | 8-Pin HMSOP (Pb-Free) | - | MDP0050 |
| EL5211IYEZ-T7 (Note) | 8-Pin HMSOP (Pb-Free) | 7" | MDP0050 |
| EL5211IYEZ-T13 (Note) | 8-Pin HMSOP (Pb-Free) | 13" | MDP0050 |
| EL5411IR | 14-Pin TSSOP | - | MDP0044 |
| EL5411IR-T7 | 14-Pin TSSOP | 7" | MDP0044 |
| EL5411IR-T13 | 14-Pin TSSOP | 13" | MDP0044 |
| EL5411IRZ (Note) | 14-Pin TSSOP (Pb-Free) | - | MDP0044 |
| EL5411IRZ-T7 (Note) | 14-Pin TSSOP (Pb-Free) | 7" | MDP0044 |
| EL5411IRZ-T13 (Note) | 14-Pin TSSOP (Pb-Free) | 13" | MDP0044 |
| EL5411IRE | 14-Pin HTSSOP | - | MDP0048 |
| EL5411IRE-T7 | 14-Pin HTSSOP | 7" | MDP0048 |
| EL5411IRE-T13 | 14-Pin HTSSOP | 13" | MDP0048 |
| EL5411IREZ (Note) | 14-Pin HTSSOP (Pb-Free) | - | MDP0048 |
| EL5411IREZ-T7 (Note) | 14-Pin HTSSOP (Pb-Free) | 7" | MDP0048 |
| EL5411IREZ-T13 (Note) | 14-Pin HTSSOP (Pb-Free) | 13" | MDP0048 |

NOTE: Intersil Pb-free products employ special Pb-free material sets; molding compounds/die attach materials and 100% matte tin plate termination finish, which is compatible with both SnPb and Pb-free soldering operations. Intersil Pb-free products are MSL classified at Pb-free peak reflow temperatures that meet or exceed the Pb-free requirements of IPC/JEDEC J Std-020B.

EL5111, EL5211, EL5411

Absolute Maximum Ratings ($T_A = 25^\circ\text{C}$)

| | |
|---|--|
| Supply Voltage between V_{S+} and V_{S-} +18V | Storage Temperature -65°C to +150°C |
| Input Voltage $V_{S-} - 0.5\text{V}$, $V_{S+} + 0.5\text{V}$ | Ambient Operating Temperature -40°C to +85°C |
| Maximum Continuous Output Current 65mA | Power Dissipation See Curves |
| Maximum Die Temperature +125°C | |

CAUTION: Stresses above those listed in "Absolute Maximum Ratings" may cause permanent damage to the device. This is a stress only rating and operation of the device at these or any other conditions above those indicated in the operational sections of this specification is not implied.

IMPORTANT NOTE: All parameters having Min/Max specifications are guaranteed. Typ values are for information purposes only. Unless otherwise noted, all tests are at the specified temperature and are pulsed tests, therefore: $T_J = T_C = T_A$

Electrical Specifications $V_{S+} = +5\text{V}$, $V_{S-} = -5\text{V}$, $R_L = 1\text{k}\Omega$ to 0V, $T_A = 25^\circ\text{C}$, Unless Otherwise Specified

| PARAMETER | DESCRIPTION | CONDITIONS | MIN | TYP | MAX | UNIT |
|---------------------------------|---------------------------------------|--|------|-----------|-------|------------------------------|
| INPUT CHARACTERISTICS | | | | | | |
| V_{OS} | Input Offset Voltage | $V_{CM} = 0\text{V}$ | | 3 | 15 | mV |
| TCV_{OS} | Average Offset Voltage Drift (Note 1) | | | 7 | | $\mu\text{V}/^\circ\text{C}$ |
| I_B | Input Bias Current | $V_{CM} = 0\text{V}$ | | 2 | 60 | nA |
| R_{IN} | Input Impedance | | | 1 | | $\text{G}\Omega$ |
| C_{IN} | Input Capacitance | | | 2 | | pF |
| CMIR | Common-Mode Input Range | | -5.5 | | +5.5 | V |
| CMRR | Common-Mode Rejection Ratio | for V_{IN} from -5.5V to 5.5V | 50 | 70 | | dB |
| A_{VOL} | Open-Loop Gain | $-4.5\text{V} \leq V_{OUT} \leq 4.5\text{V}$ | 62 | 70 | | dB |
| OUTPUT CHARACTERISTICS | | | | | | |
| V_{OL} | Output Swing Low | $I_L = -5\text{mA}$ | | -4.92 | -4.85 | V |
| V_{OH} | Output Swing High | $I_L = 5\text{mA}$ | 4.85 | 4.92 | | V |
| I_{SC} | Short-Circuit Current | | | ± 180 | | mA |
| I_{OUT} | Output Current | | | ± 65 | | mA |
| POWER SUPPLY PERFORMANCE | | | | | | |
| PSRR | Power Supply Rejection Ratio | V_S is moved from $\pm 2.25\text{V}$ to $\pm 7.75\text{V}$ | 60 | 80 | | dB |
| I_S | Supply Current (Per Amplifier) | No load | | 2.5 | 3.75 | mA |
| DYNAMIC PERFORMANCE | | | | | | |
| SR | Slew Rate (Note 2) | $-4.0\text{V} \leq V_{OUT} \leq 4.0\text{V}$, 20% to 80% | | 75 | | $\text{V}/\mu\text{s}$ |
| t_S | Settling to +0.1% ($A_V = +1$) | ($A_V = +1$), $V_O = 2\text{V}$ step | | 80 | | ns |
| BW | -3dB Bandwidth | | | 60 | | MHz |
| GBWP | Gain-Bandwidth Product | | | 32 | | MHz |
| PM | Phase Margin | | | 50 | | $^\circ$ |
| CS | Channel Separation | $f = 5\text{MHz}$ (EL5211 & EL5411 only) | | 110 | | dB |
| d_G | Differential Gain (Note 3) | $R_F = R_G = 1\text{k}\Omega$ and $V_{OUT} = 1.4\text{V}$ | | 0.17 | | % |
| d_P | Differential Phase (Note 3) | $R_F = R_G = 1\text{k}\Omega$ and $V_{OUT} = 1.4\text{V}$ | | 0.24 | | $^\circ$ |

NOTES:

1. Measured over operating temperature range.
2. Slew rate is measured on rising and falling edges.
3. NTSC signal generator used.

EL5111, EL5211, EL5411

Electrical Specifications $V_{S+} = +5V$, $V_{S-} = 0V$, $R_L = 1k\Omega$ to $2.5V$, $T_A = 25^\circ C$, Unless Otherwise Specified

| PARAMETER | DESCRIPTION | CONDITION | MIN | TYP | MAX | UNIT |
|---------------------------------|---------------------------------------|---|------|-----------|------|------------------|
| INPUT CHARACTERISTICS | | | | | | |
| V_{OS} | Input Offset Voltage | $V_{CM} = 2.5V$ | | 3 | 15 | mV |
| TCV_{OS} | Average Offset Voltage Drift (Note 4) | | | 7 | | $\mu V/^\circ C$ |
| I_B | Input Bias Current | $V_{CM} = 2.5V$ | | 2 | 60 | nA |
| R_{IN} | Input Impedance | | | 1 | | $G\Omega$ |
| C_{IN} | Input Capacitance | | | 2 | | pF |
| CMIR | Common-Mode Input Range | | -0.5 | | +5.5 | V |
| CMRR | Common-Mode Rejection Ratio | for V_{IN} from -0.5V to 5.5V | 45 | 66 | | dB |
| A_{VOL} | Open-Loop Gain | $0.5V \leq V_{OUT} \leq 4.5V$ | 62 | 70 | | dB |
| OUTPUT CHARACTERISTICS | | | | | | |
| V_{OL} | Output Swing Low | $I_L = -5mA$ | | 80 | 150 | mV |
| V_{OH} | Output Swing High | $I_L = 5mA$ | 4.85 | 4.92 | | V |
| I_{SC} | Short-circuit Current | | | ± 180 | | mA |
| I_{OUT} | Output Current | | | ± 65 | | mA |
| POWER SUPPLY PERFORMANCE | | | | | | |
| PSRR | Power Supply Rejection Ratio | V_S is moved from 4.5V to 15.5V | 60 | 80 | | dB |
| I_S | Supply Current (Per Amplifier) | No load | | 2.5 | 3.75 | mA |
| DYNAMIC PERFORMANCE | | | | | | |
| SR | Slew Rate (Note 5) | $1V \leq V_{OUT} \leq 4V$, 20% to 80% | | 75 | | $V/\mu s$ |
| t_S | Settling to +0.1% ($A_V = +1$) | ($A_V = +1$), $V_O = 2V$ step | | 80 | | ns |
| BW | -3dB Bandwidth | | | 60 | | MHz |
| GBWP | Gain-Bandwidth Product | | | 32 | | MHz |
| PM | Phase Margin | | | 50 | | $^\circ$ |
| CS | Channel Separation | $f = 5MHz$ (EL5211 & EL5411 only) | | 110 | | dB |
| d_G | Differential Gain (Note 6) | $R_F = R_G = 1k\Omega$ and $V_{OUT} = 1.4V$ | | 0.17 | | % |
| d_P | Differential Phase (Note 6) | $R_F = R_G = 1k\Omega$ and $V_{OUT} = 1.4V$ | | 0.24 | | $^\circ$ |

NOTES:

4. Measured over operating temperature range.
5. Slew rate is measured on rising and falling edges.
6. NTSC signal generator used.

Electrical Specifications $V_{S+} = +15V$, $V_{S-} = 0V$, $R_L = 1k\Omega$ to $7.5V$, $T_A = 25^\circ C$, Unless Otherwise Specified

| PARAMETER | DESCRIPTION | CONDITION | MIN | TYP | MAX | UNIT |
|------------------------------|---------------------------------------|-----------------|------|-----|-------|------------------|
| INPUT CHARACTERISTICS | | | | | | |
| V_{OS} | Input Offset Voltage | $V_{CM} = 7.5V$ | | 3 | 15 | mV |
| TCV_{OS} | Average Offset Voltage Drift (Note 7) | | | 7 | | $\mu V/^\circ C$ |
| I_B | Input Bias Current | $V_{CM} = 7.5V$ | | 2 | 60 | nA |
| R_{IN} | Input Impedance | | | 1 | | $G\Omega$ |
| C_{IN} | Input Capacitance | | | 2 | | pF |
| CMIR | Common-Mode Input Range | | -0.5 | | +15.5 | V |

Electrical Specifications $V_{S+} = +15V$, $V_{S-} = 0V$, $R_L = 1k\Omega$ to $7.5V$, $T_A = 25^\circ C$, Unless Otherwise Specified (Continued)

| PARAMETER | DESCRIPTION | CONDITION | MIN | TYP | MAX | UNIT |
|---------------------------------|--|---|-------|-----------|------|------------|
| CMRR | Common-Mode Rejection Ratio | for V_{IN} from $-0.5V$ to $15.5V$ | 53 | 72 | | dB |
| A_{VOL} | Open-Loop Gain | $0.5V \leq V_{OUT} \leq 14.5V$ | 62 | 70 | | dB |
| OUTPUT CHARACTERISTICS | | | | | | |
| V_{OL} | Output Swing Low | $I_L = -5mA$ | | 80 | 150 | mV |
| V_{OH} | Output Swing High | $I_L = 5mA$ | 14.85 | 14.92 | | V |
| I_{SC} | Short-circuit Current | | | ± 180 | | mA |
| I_{OUT} | Output Current | | | ± 65 | | mA |
| POWER SUPPLY PERFORMANCE | | | | | | |
| PSRR | Power Supply Rejection Ratio | V_S is moved from $4.5V$ to $15.5V$ | 60 | 80 | | dB |
| I_S | Supply Current (Per Amplifier) | No load | | 2.5 | 3.75 | mA |
| DYNAMIC PERFORMANCE | | | | | | |
| SR | Slew Rate (Note 8) | $1V \leq V_{OUT} \leq 14V$, 20% to 80% | | 75 | | V/ μs |
| t_S | Settling to $\pm 0.1\%$ ($A_V = +1$) | ($A_V = +1$), $V_O = 2V$ step | | 80 | | ns |
| BW | -3dB Bandwidth | | | 60 | | MHz |
| GBWP | Gain-Bandwidth Product | | | 32 | | MHz |
| PM | Phase Margin | | | 50 | | $^\circ$ |
| CS | Channel Separation | $f = 5MHz$ (EL5211 & EL5411 only) | | 110 | | dB |
| d_G | Differential Gain (Note 9) | $R_F = R_G = 1k\Omega$ and $V_{OUT} = 1.4V$ | | 0.16 | | % |
| d_P | Differential Phase (Note 9) | $R_F = R_G = 1k\Omega$ and $V_{OUT} = 1.4V$ | | 0.22 | | $^\circ$ |

NOTES:

- 7. Measured over operating temperature range
- 8. Slew rate is measured on rising and falling edges
- 9. NTSC signal generator used

Typical Performance Curves

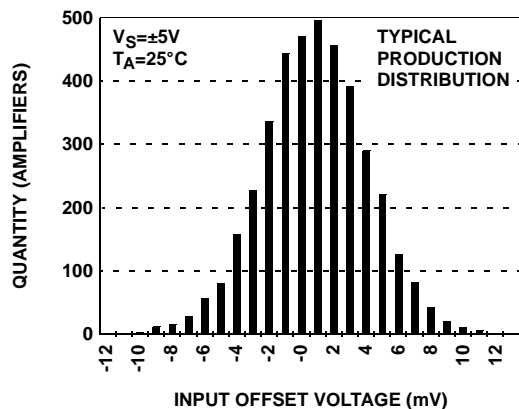

FIGURE 1. INPUT OFFSET VOLTAGE DISTRIBUTION

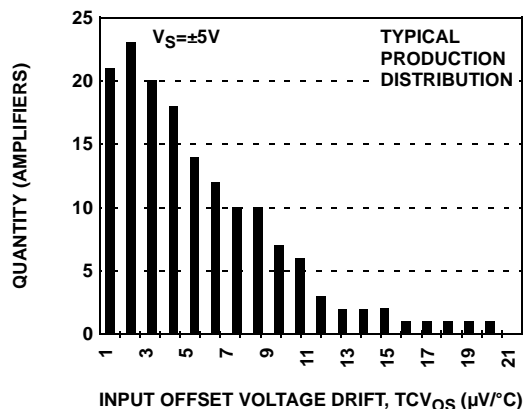

FIGURE 2. INPUT OFFSET VOLTAGE DRIFT

Typical Performance Curves (Continued)

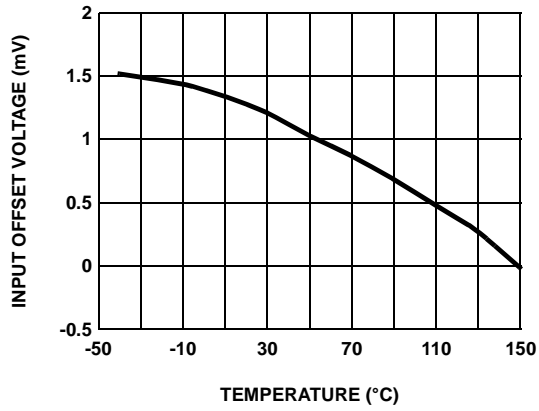

FIGURE 3. INPUT OFFSET VOLTAGE vs TEMPERATURE

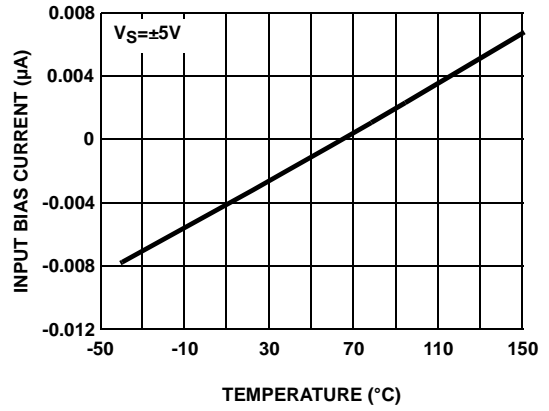

FIGURE 4. INPUT BIAS CURRENT vs TEMPERATURE

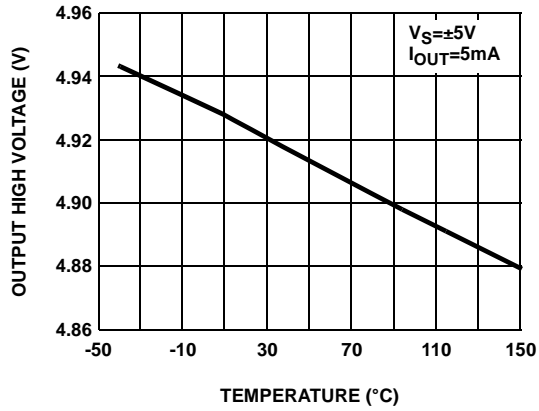

FIGURE 5. OUTPUT HIGH VOLTAGE vs TEMPERATURE

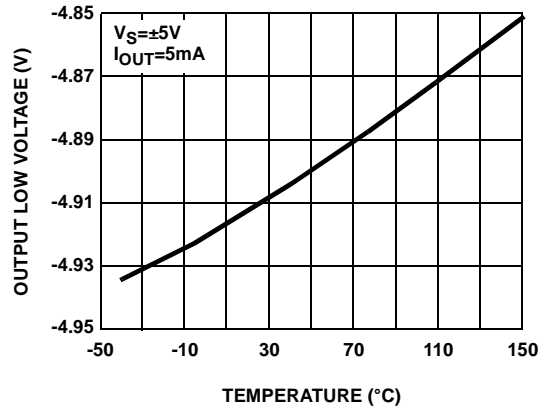

FIGURE 6. OUTPUT LOW VOLTAGE vs TEMPERATURE

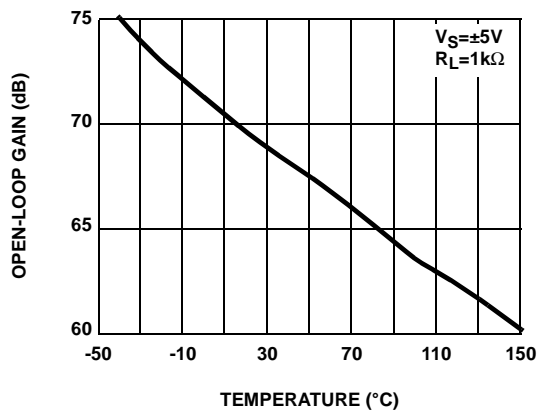

FIGURE 7. OPEN-LOOP GAIN vs TEMPERATURE

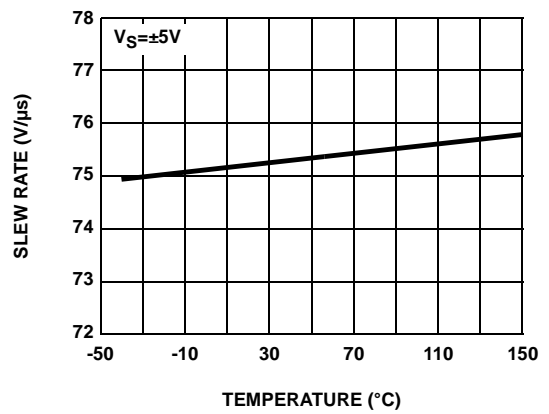

FIGURE 8. SLEW RATE vs TEMPERATURE

Typical Performance Curves (Continued)

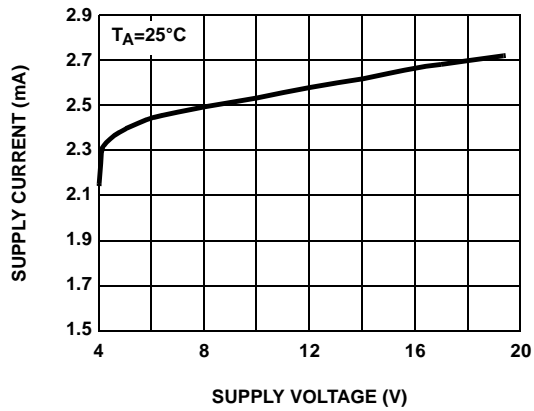

FIGURE 9. SUPPLY CURRENT PER AMPLIFIER vs SUPPLY VOLTAGE

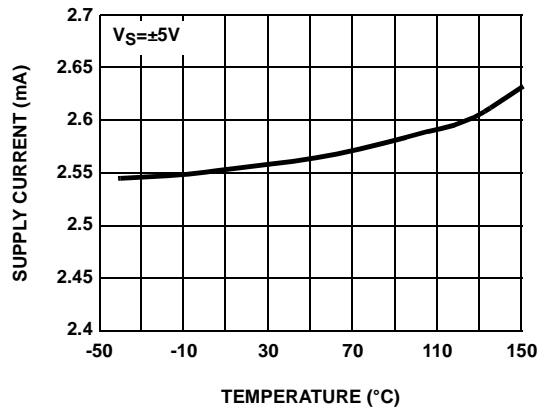

FIGURE 10. SUPPLY CURRENT PER AMPLIFIER vs TEMPERATURE

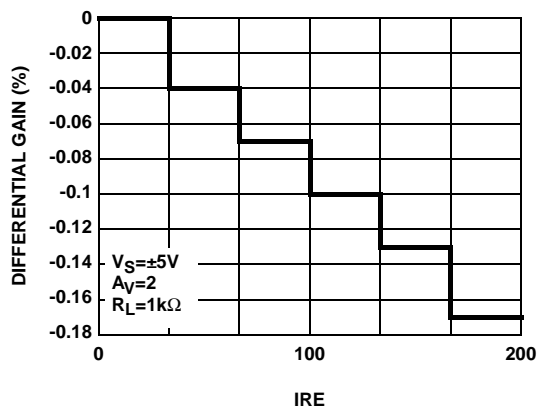

FIGURE 11. DIFFERENTIAL GAIN

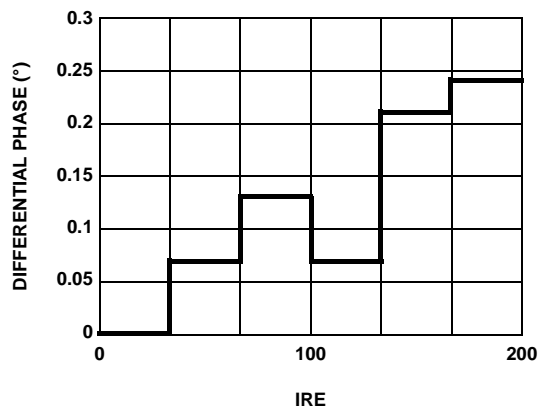

FIGURE 12. DIFFERENTIAL PHASE

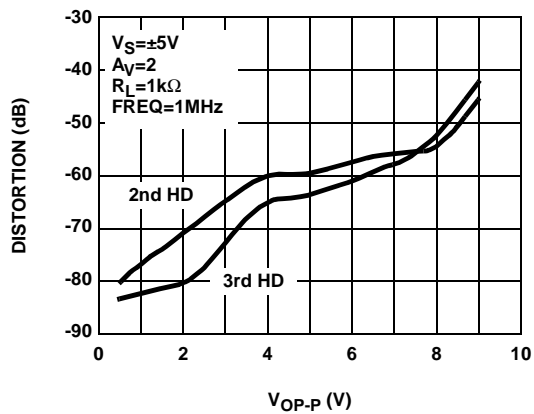

FIGURE 13. HARMONIC DISTORTION vs V_{OP-P}

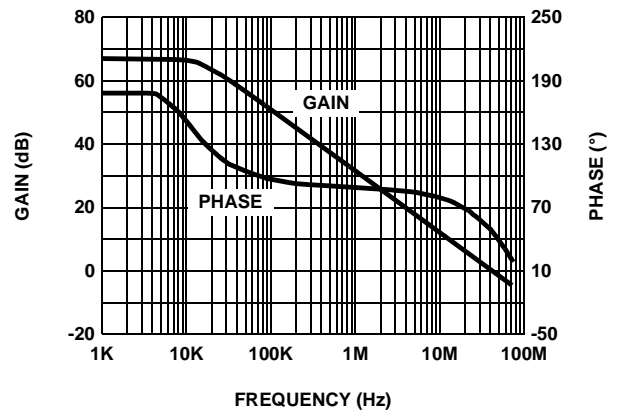

FIGURE 14. OPEN LOOP GAIN AND PHASE

Typical Performance Curves (Continued)

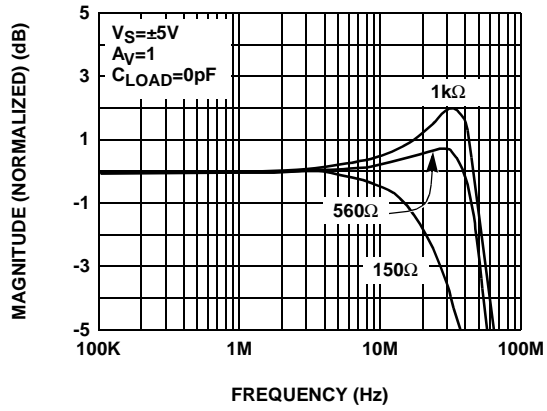

FIGURE 15. FREQUENCY RESPONSE FOR VARIOUS R_L

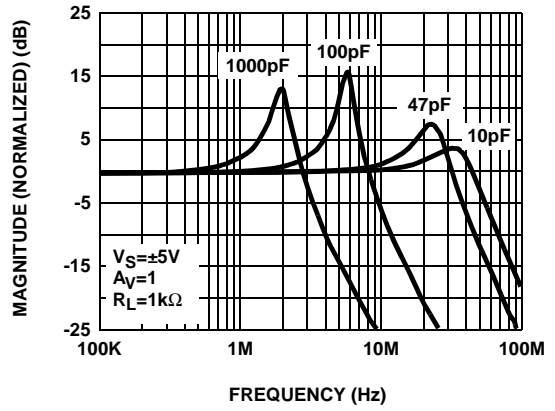

FIGURE 16. FREQUENCY RESPONSE FOR VARIOUS C_L

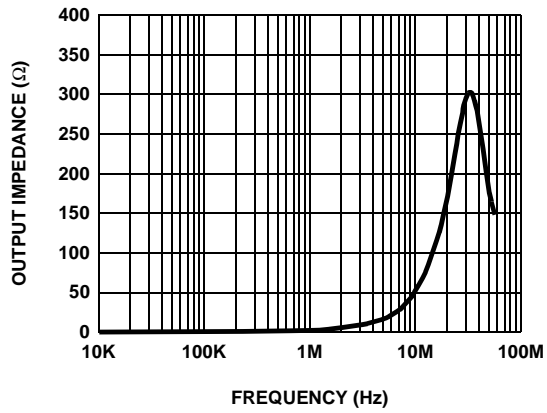

FIGURE 17. CLOSED LOOP OUTPUT IMPEDANCE

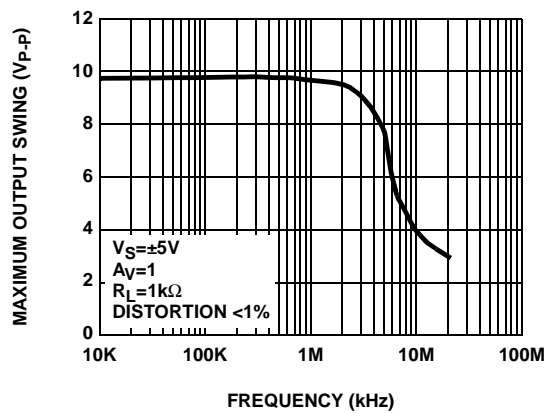

FIGURE 18. MAXIMUM OUTPUT SWING vs FREQUENCY

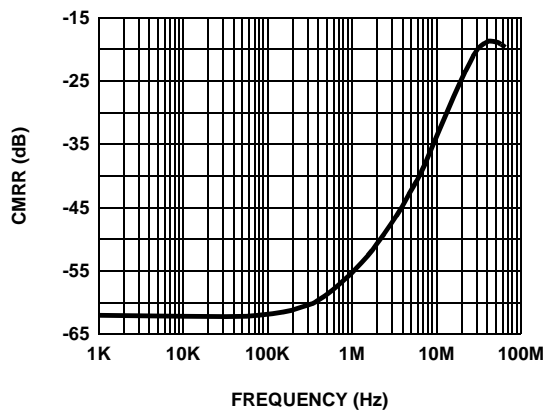

FIGURE 19. CMRR

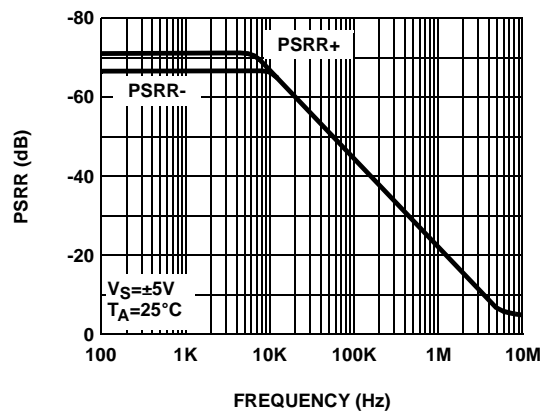

FIGURE 20. PSRR

Typical Performance Curves (Continued)

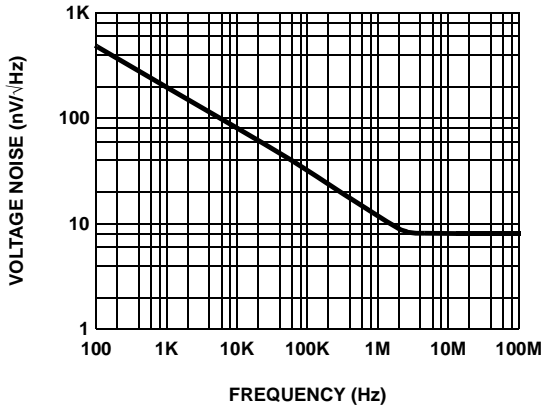

FIGURE 21. INPUT VOLTAGE NOISE SPECTRAL DENSITY

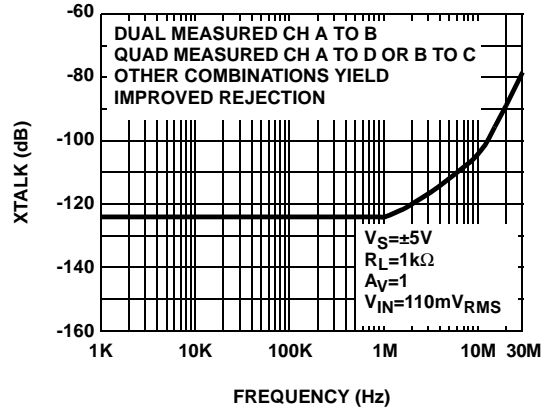

FIGURE 22. CHANNEL SEPARATION

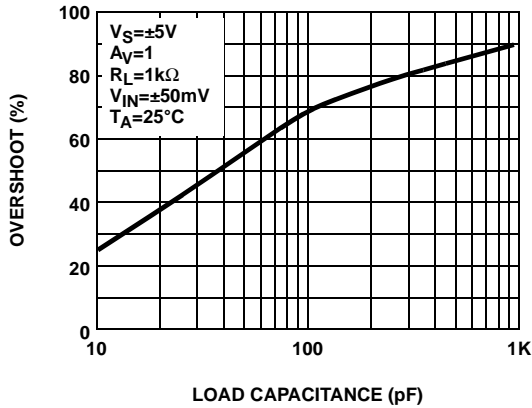

FIGURE 23. SMALL-SIGNAL OVERSHOOT vs LOAD CAPACITANCE

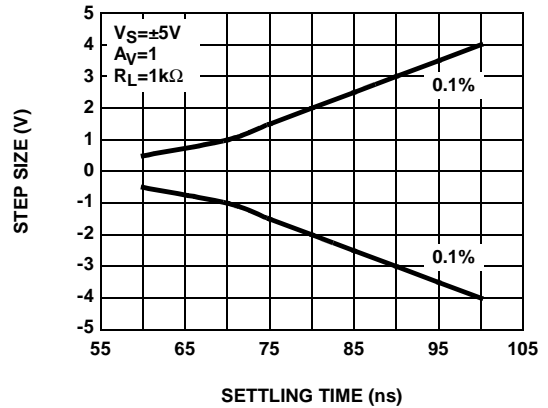

FIGURE 24. SETTLING TIME vs STEP SIZE

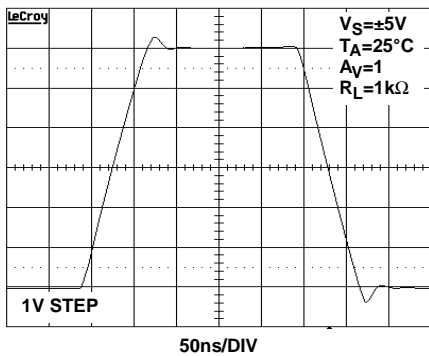

FIGURE 25. LARGE SIGNAL TRANSIENT RESPONSE

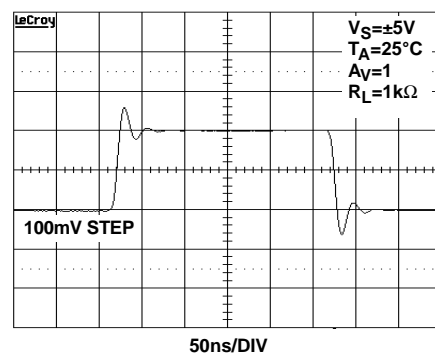

FIGURE 26. SMALL SIGNAL TRANSIENT RESPONSE

Pin Descriptions

| EL5111 (TSOT-5) | EL5111 (HMSOP8) | EL5211 (MSOP8, HMSOP8) | EL5411 (TSSOP14, HTSSOP14) | NAME | FUNCTION | EQUIVALENT CIRCUIT |
|-----------------|-----------------|------------------------|----------------------------|-------|---------------------------------|-----------------------|
| 1 | 6 | 1 | 1 | VOUTA | Amplifier A output | <p>CIRCUIT 1</p> |
| 4 | 2 | 2 | 2 | VINA- | Amplifier A inverting input | <p>CIRCUIT 2</p> |
| 3 | 3 | 3 | 3 | VINA+ | Amplifier A non-inverting input | (Reference Circuit 2) |
| 5 | 7 | 8 | 4 | VS+ | Positive power supply | |
| | | 5 | 5 | VINB+ | Amplifier B non-inverting input | (Reference Circuit 2) |
| | | 6 | 6 | VINB- | Amplifier B inverting input | (Reference Circuit 2) |
| | | 7 | 7 | VOUTB | Amplifier B output | (Reference Circuit 1) |
| | | | 8 | VOUTC | Amplifier C output | (Reference Circuit 1) |
| | | | 9 | VINC- | Amplifier C inverting input | (Reference Circuit 2) |
| | | | 10 | VINC+ | Amplifier C non-inverting input | (Reference Circuit 2) |
| 2 | 4 | 4 | 11 | VS- | Negative power supply | |
| | | | 12 | VIND+ | Amplifier D non-inverting input | (Reference Circuit 2) |
| | | | 13 | VIND- | Amplifier D inverting input | (Reference Circuit 2) |
| | | | 14 | VOUTD | Amplifier D output | (Reference Circuit 1) |
| | 1, 5, 8 | | | NC | Not connected | |

Applications Information

Product Description

The EL5111, EL5211, and EL5411 voltage feedback amplifiers are fabricated using a high voltage CMOS process. They exhibit rail-to-rail input and output capability, are unity gain stable and have low power consumption (2.5mA per amplifier). These features make the EL5111, EL5211, and EL5411 ideal for a wide range of general-purpose applications. Connected in voltage follower mode and driving a load of 1kΩ, the EL5111, EL5211, and EL5411 have a -3dB bandwidth of 60MHz while maintaining a 75V/μs slew rate. The EL5111 is a single amplifier, the EL5211 a dual amplifier, and the EL5411 a quad amplifier.

Operating Voltage, Input, and Output

The EL5111, EL5211, and EL5411 are specified with a single nominal supply voltage from 5V to 15V or a split supply with its total range from 5V to 15V. Correct operation is guaranteed for a supply range of 4.5V to 16.5V. Most EL5111, EL5211, and EL5411 specifications are stable over both the full supply range and operating temperatures of -40°C to +85°C. Parameter variations with operating voltage and/or temperature are shown in the typical performance curves.

The input common-mode voltage range of the EL5111, EL5211, and EL5411 extends 500mV beyond the supply rails. The output swings of the EL5111, EL5211, and EL5411 typically extend to within 100mV of positive and negative supply rails with load currents of 5mA. Decreasing load

currents will extend the output voltage range even closer to the supply rails. Figure 27 shows the input and output waveforms for the device in the unity-gain configuration. Operation is from $\pm 5V$ supply with a $1k\Omega$ load connected to GND. The input is a $10V_{P-P}$ sinusoid. The output voltage is approximately $9.8V_{P-P}$.

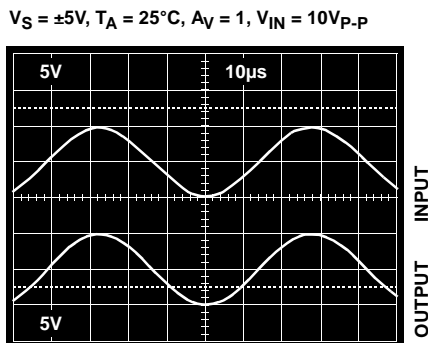

FIGURE 27. OPERATION WITH RAIL-TO-RAIL INPUT AND OUTPUT

Short Circuit Current Limit

The EL5111, EL5211, and EL5411 will limit the short circuit current to $\pm 180mA$ if the output is directly shorted to the positive or the negative supply. If an output is shorted indefinitely, the power dissipation could easily increase such that the device may be damaged. Maximum reliability is maintained if the output continuous current never exceeds $\pm 65mA$. This limit is set by the design of the internal metal interconnects.

Output Phase Reversal

The EL5111, EL5211, and EL5411 are immune to phase reversal as long as the input voltage is limited from $V_S - 0.5V$ to $V_S + 0.5V$. Figure 28 shows a photo of the output of the device with the input voltage driven beyond the supply rails. Although the device's output will not change phase, the input's overvoltage should be avoided. If an input voltage exceeds supply voltage by more than $0.6V$, electrostatic protection diodes placed in the input stage of the device begin to conduct and overvoltage damage could occur.

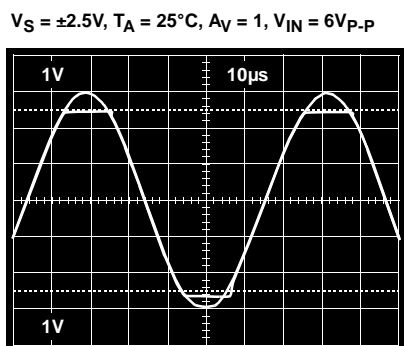

FIGURE 28. OPERATION WITH BEYOND-THE-RAILS INPUT

Power Dissipation

With the high-output drive capability of the EL5111, EL5211, and EL5411 amplifiers, it is possible to exceed the $125^\circ C$ 'absolute-maximum junction temperature' under certain load current conditions. Therefore, it is important to calculate the maximum junction temperature for the application to determine if load conditions need to be modified for the amplifier to remain in the safe operating area.

The maximum power dissipation allowed in a package is determined according to:

$$P_{DMAX} = \frac{T_{JMAX} - T_{AMAX}}{\Theta_{JA}}$$

where:

- T_{JMAX} = Maximum junction temperature
- T_{AMAX} = Maximum ambient temperature
- Θ_{JA} = Thermal resistance of the package
- P_{DMAX} = Maximum power dissipation in the package

The maximum power dissipation actually produced by an IC is the total quiescent supply current times the total power supply voltage, plus the power in the IC due to the loads, or:

$$P_{DMAX} = \sum i[V_S \times I_{SMAX} + (V_S + V_{OUTi}) \times I_{LOADi}]$$

when sourcing, and:

$$P_{DMAX} = \sum i[V_S \times I_{SMAX} + (V_{OUTi} - V_S) \times I_{LOADi}]$$

when sinking,

where:

- $i = 1$ to 2 for dual and 1 to 4 for quad
- V_S = Total supply voltage
- I_{SMAX} = Maximum supply current per amplifier
- V_{OUTi} = Maximum output voltage of the application
- I_{LOADi} = Load current

If we set the two P_{DMAX} equations equal to each other, we can solve for R_{LOADi} to avoid device overheat. Figures 29, 30, and 31 provide a convenient way to see if the device will overheat. The maximum safe power dissipation can be found graphically, based on the package type and the ambient temperature. By using the previous equation, it is a simple matter to see if P_{DMAX} exceeds the device's power derating curves. To ensure proper operation, it is important to observe the recommended derating curves shown in Figures 29, 30 & 31.

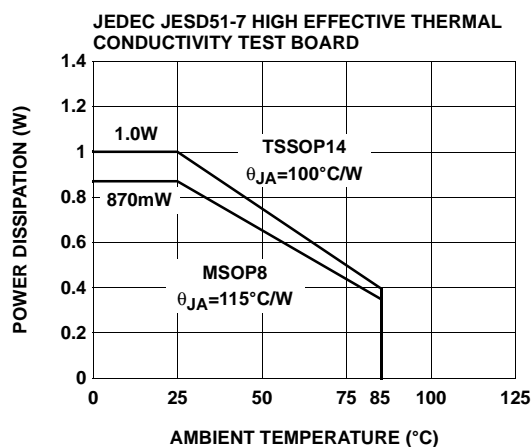

FIGURE 29. PACKAGE POWER DISSIPATION vs AMBIENT TEMPERATURE

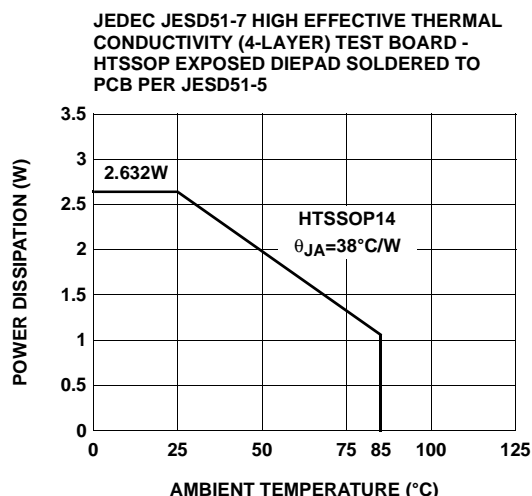

FIGURE 31. PACKAGE POWER DISSIPATION vs AMBIENT TEMPERATURE

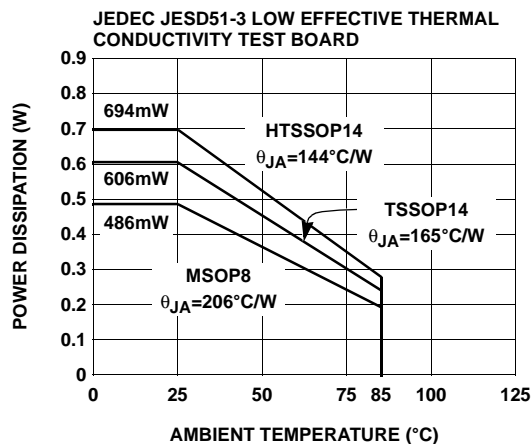

FIGURE 30. PACKAGE POWER DISSIPATION vs AMBIENT TEMPERATURE

Unused Amplifiers

It is recommended that any unused amplifiers in a dual and a quad package be configured as a unity gain follower. The inverting input should be directly connected to the output and the non-inverting input tied to the ground plane.

Power Supply Bypassing and Printed Circuit Board Layout

The EL5111, EL5211, and EL5411 can provide gain at high frequency. As with any high-frequency device, good printed circuit board layout is necessary for optimum performance. Ground plane construction is highly recommended, lead lengths should be as short as possible and the power supply pins must be well bypassed to reduce the risk of oscillation. For normal single supply operation, where the V_S^- pin is connected to ground, a 0.1 μ F ceramic capacitor should be placed from V_S^+ to pin to V_S^- pin. A 4.7 μ F tantalum capacitor should then be connected in parallel, placed in the region of the amplifier. One 4.7 μ F capacitor may be used for multiple devices. This same capacitor combination should be placed at each supply pin to ground if split supplies are to be used.

All Intersil U.S. products are manufactured, assembled and tested utilizing ISO9000 quality systems. Intersil Corporation's quality certifications can be viewed at www.intersil.com/design/quality

Intersil products are sold by description only. Intersil Corporation reserves the right to make changes in circuit design, software and/or specifications at any time without notice. Accordingly, the reader is cautioned to verify that data sheets are current before placing orders. Information furnished by Intersil is believed to be accurate and reliable. However, no responsibility is assumed by Intersil or its subsidiaries for its use; nor for any infringements of patents or other rights of third parties which may result from its use. No license is granted by implication or otherwise under any patent or patent rights of Intersil or its subsidiaries.

For information regarding Intersil Corporation and its products, see www.intersil.com



LittleDiode supplies new, hard to find or obsolete electronic components and semiconductors all over the world.

With over two million different components listed you are sure to find the part you need.

Feel free to visit us today at our online store:

LittleDiode.com

Looking forward to providing you with the best possible service.