

CLC115

Quad, Closed-Loop Monolithic Buffer

General Description

The CLC115 is a high performance, closed-loop, quad buffer designed for high density applications requiring a low-cost-per-channel solution to buffering high-frequency signals. The CLC115's high performance includes a 700MHz small signal bandwidth (0.5Vpp) and a 2700V/ μ s slew rate while requiring only 11mA quiescent current per channel. Signal fidelity is maintained with low harmonic distortion (-62 dBc 2nd and 3rd harmonics at 20MHz), and wide channel separation (60dB crosstalk at 10MHz).

Featuring a unique closed-loop design, the CLC115 offers true unity-gain stability and very low output impedance plus a 60mA per channel output drive capability. The CLC115 is ideally suited for buffering video signals with its 0.08%/0.04° differential gain and phase performance at 3.58MHz. Applications such as analog multiplexing and high-speed A/D converters will benefit from the CLC115's high signal fidelity.

The CLC115 offers a low-cost-per-channel solution to high-speed buffering with four high-performance, closed-loop buffers integrated in one 14-pin package.

Constructed using an advanced, complimentary bipolar process and National's proven current feedback architectures, the CLC115 is available in several versions to meet a variety of requirements.

CLC115AJP	-40°C to +85°C	8-pin plastic DIP
CLC115AJE	-40°C to +85°C	8-pin plastic SOIC
CLC115ALC	-40°C to +85°C	dice
CLC115AMC	-55°C to +125°C	dice qualified to Method 5008, MIL-STD-883, Level B MIL-STD-883, Level B

Contact factory for other packages and DESC SMD number.

Features

- Closed-loop, quad buffer
- 700MHz small-signal bandwidth
- 270V/ μ s slew rate
- 0.08%/0.04° differential gain/phase
- 60dB channel isolation (10MHz)
- -62dBc 2nd and 3rd harmonics at 20MHz
- 60mA current output per channel

Applications

- Multi-channel video distribution
- Video switching buffers
- High-speed analog multiplexing
- Channelized EW
- High-density buffering
- Instrumentation amps
- Active filters

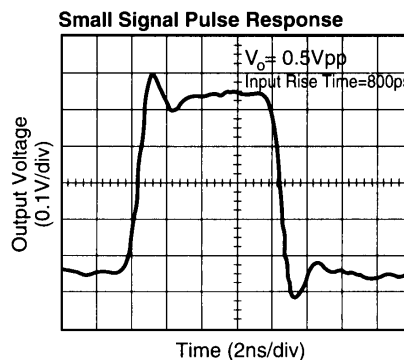

Pinout

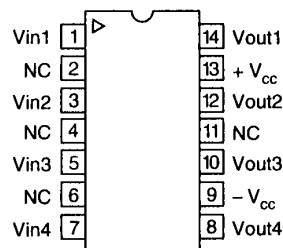

CLC115 Electrical Characteristics ($V_{CC} = \pm 5V, R_L = 100\Omega$; unless specified)

PARAMETERS	CONDITIONS	TYP	MAX AND MIN RATINGS			UNITS	SYMBOL
			-40°C	+25°C	+85°C		
Ambient Temperature	CLC115AJ	+25°C	-40°C	+25°C	+85°C		
FREQUENCY DOMAIN RESPONSE							
-3dB bandwidth	$V_{out} < 0.5V_{pp}$	700	400	400	300	MHz	SSBW
	$V_{out} < 4V_{pp}$	270	200	200	150	MHz	LSBW
gain flatness	$V_{out} < 0.5V_{pp}$						
flatness	DC to 30MHz ¹	±0.0	±0.1	±0.1	±0.1	dB	GFL
peaking	30MHz to 200MHz	0.4	1.4	1.0	1.0	dB	GFPH
rolloff	30MHz to 200MHz	0.0	0.5	0.5	0.5	dB	GFRH
differential gain	4.43MHz, 150Ω load	0.08	0.25	0.15	0.15	%	DG
differential phase	4.43MHz, 150Ω load	0.04	0.08	0.08	0.08	°	DP
crosstalk (all hostile)	10MHz	60	57	57	57	dB	XT
TIME DOMAIN RESPONSE							
rise and fall time	4V step	1.4	2.0	2.0	2.4	ns	TRS
settling time to 0.1%	2V step	12	17	17	17	ns	TS
overshoot	4V step input $t_{rise} < 4ns$	5	15	12	12	%	OS1
	input $t_{rise} > 4ns$	0	2	2	2	%	OS2
slew rate		2700	2200	2200	1800	V/μs	SR
DISTORTION AND NOISE RESPONSE							
2nd harmonic distortion	$2V_{pp}$, 20MHz	-62	-45	-47	-47	dBc	HD2
3rd harmonic distortion	$2V_{pp}$, 20MHz	-62	-53	-53	-50	dBc	HD3
equivalent noise input							
noise floor	>1MHz	-157	-155	-155	-154	dBm _{1Hz}	SNF
STATIC DC PERFORMANCE							
small signal gain	no load	0.995	0.97	0.99	0.99	V/V	GA
integral endpoint linearity	±2V, full scale	0.2	1.4	0.5	0.5	%	ILIN
*output offset voltage		±2	±17	±9	±9	mV	VIO
average temperature coefficient		±25	±100	-	±50	μV/°C	DVIO
*input bias current		±8	±35	±20	±20	μA	IBN
average temperature coefficient		±66	±187	-	±125	nA/°C	DIBN
power supply rejection ratio		54	46	48	46	dB	PSRR
*supply current	total, no load	45	61	61	61	mA	ICC
MISCELLANEOUS PERFORMANCE							
input resistance		750	100	450	450	kΩ	RIN
input capacitance		1.6	2.2	2.2	2.2	pF	CIN
output resistance	DC	1.1	4.5	2.0	2.0	Ω	RO
output voltage range	no load	±4.0	±3.8	±3.9	±3.9	V	VO
output voltage range	$R_L = 100\Omega$	±3.7	±2.2	±3.4	±3.0	V	VOL
output current		±60	±25	±48	±30	mA	IO

Min/max ratings are based on product characterization and simulation. Individual parameters are tested as noted. Outgoing quality levels are determined from tested parameters.

Absolute Maximum Ratings

V_{CC}	±7V
I_{out}	output is short circuit protected to ground, however, maximum reliability is obtained if I_{out} does not exceed... 80mA
input voltage	± V_{CC}
maximum junction temperature	+150°C
operating temperature range	
AJ:	-40°C to +85°C
storage temperature range	-65°C to +150°C
lead temperature (soldering 10 sec)	+300°C
ESD	≥4000V

Miscellaneous Ratings

NOTES:

- * AJ 100% tested at +25°C.
- note 1: Specification is guaranteed for ($50\Omega \leq R_L \leq 200\Omega$).

Package Thermal Resistance

Package	θ_{JC}	θ_{JA}
Plastic (AJP)	55°C/W	105°C/W
Surface Mount (AJE)	45°C/W	115°C/W

Reliability Information

Transistor Count

64

CLC115 Typical Performance Characteristics ($T_A = +25^\circ$, $V_{CC} = \pm 5V$, $R_L = 100\Omega$; unless specified)

Gain and Phase vs. Load ($V_o = 4V_{pp}$)

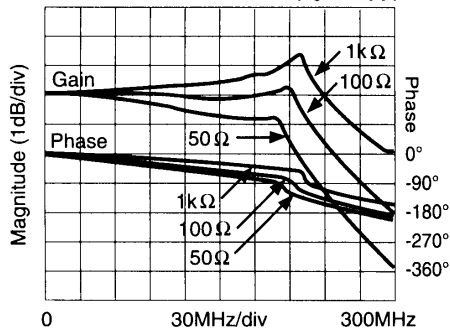

Output Impedance

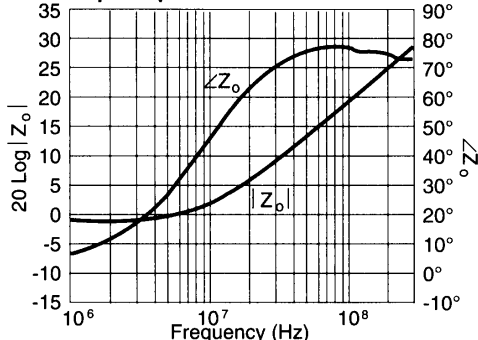

Input Impedance

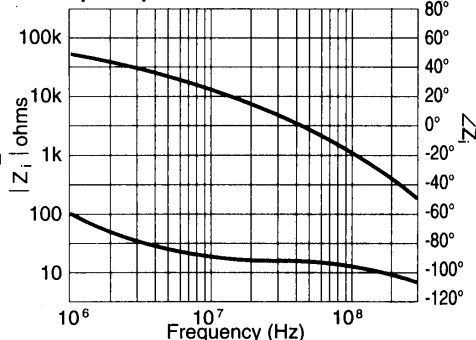

PSRR

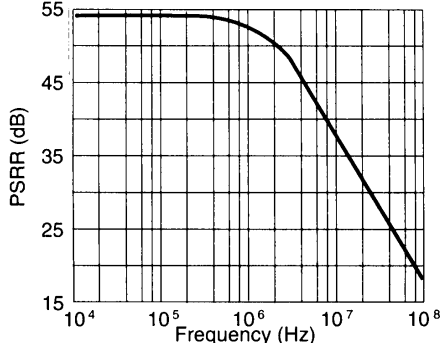

Recommended R_s vs. Load Capacitance

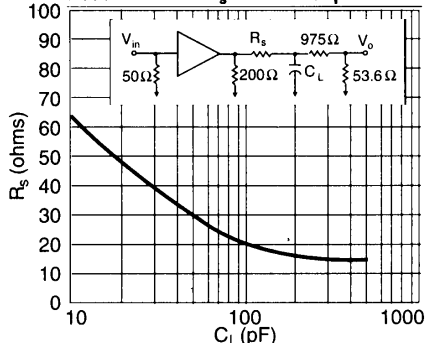

$|S_{21}|$ vs. C_L with Recommended R_s

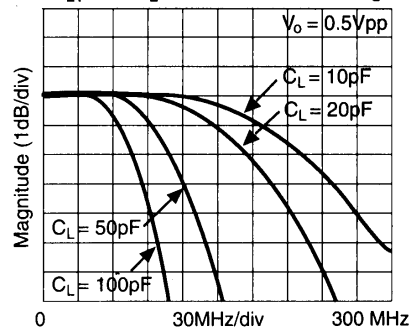

Small Signal Pulse Response

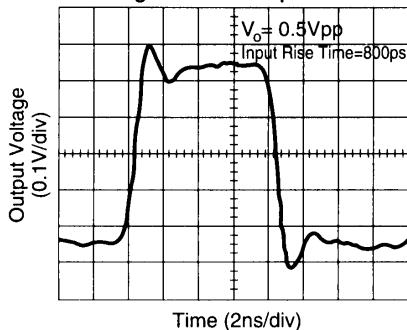

Large Signal Pulse Response

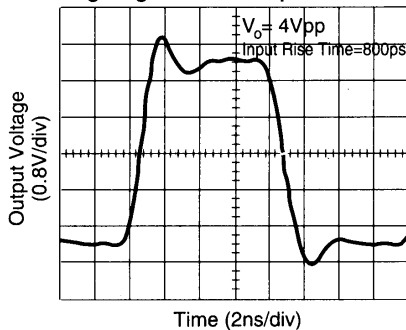

Integral Linearity Error

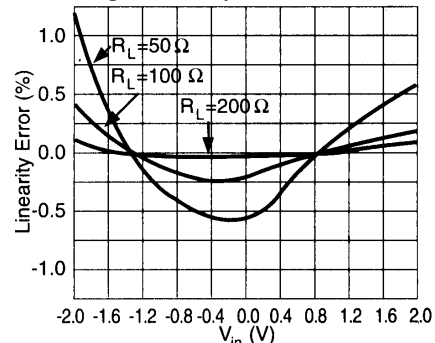

Short-Term Settling Time

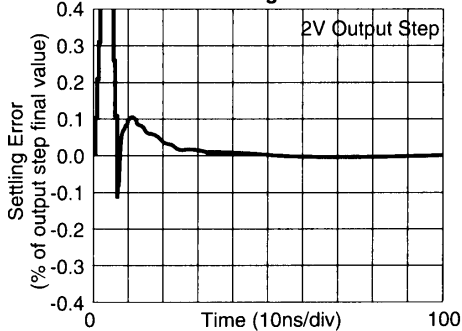

Long-Term Settling Time

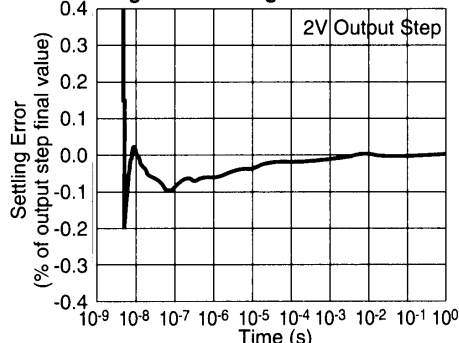

Typical D.C. Errors vs. Temperature

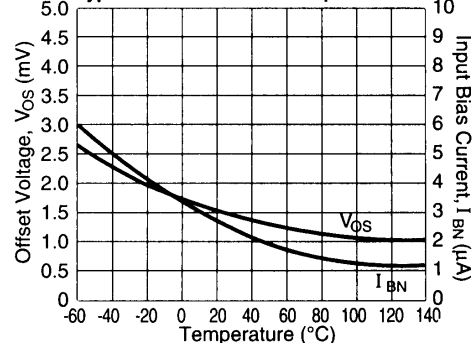

Equivalent Input Noise

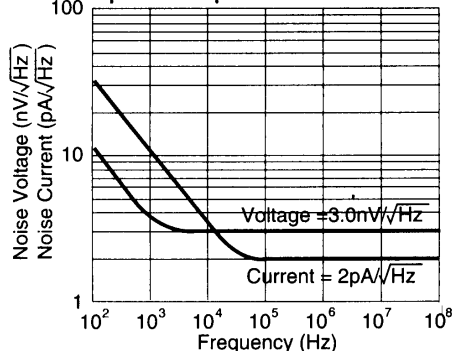

2nd and 3rd Harmonic Distortion

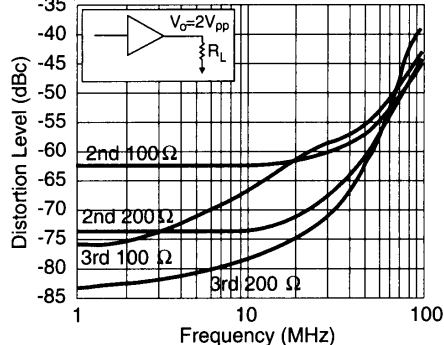

2-Tone, 3rd Order Intermodulation Intercept

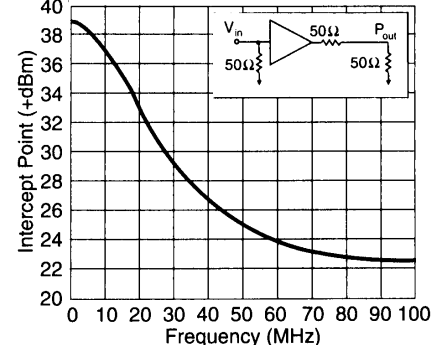

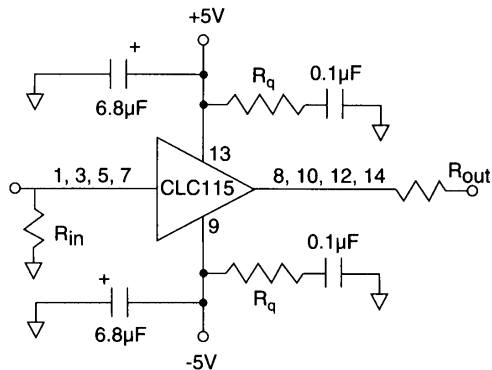

Figure 1: recommended circuit

PC Board Layout and Circuit Design

For optimum performance, high frequency devices demand a good printed circuit board layout. A ground plane and power supply bypassing with good high-frequency ceramic capacitors in close proximity to the supply pins is essential. Second harmonic distortion can be improved by ensuring equal current return paths for both the positive and negative supplies.

The dominant pole, i.e. the high-frequency compensation of the CLC115, is set by the load resistance, R_L . Ideally, each buffer of the CLC115 should see a 100Ω load at high frequency to ensure stability. An unterminated channel is undercompensated and will exhibit gain at several hundred megahertz. Signal coupling may occur between channels through the common power supply connections. Any resonance in the power supply can lead to oscillations in the unterminated or undercompensated channel.

In order to compensate and to guarantee the stability of the four CLC115 channels, each must be terminated with a 100Ω resistance to ground. If a dc load is not desired, a two picofarad capacitor can be inserted between the 100Ω load resistor and ground, as shown in Figure 2.

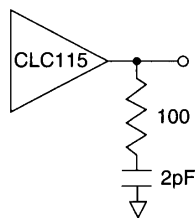

Figure 2: AC load

If the above load conditions are not feasible for your design, the power supply resonance must be addressed. Chip capacitors have less parasitic inductance than leaded ceramic capacitors. The use of 0.1µF chip capacitors mounted immediately adjacent to the power supply pins eliminates the resonance which can lead to oscillations. If chip capacitors are not used, then the only other means to eliminate the possibility of oscillation caused by power supply resonance is to 'de-Q' the resonant structure. 'De-Q'ing is particularly necessary while using leaded capacitors and can be achieved by inserting a 10Ω resistor, R_q , in series with the 0.1µF bypass capacitor, as shown in Figure 1. The insertion of the 'de-Q'ing resistor will reduce frequency response peaking as well as the tendency toward oscillation when driving a load resistance greater than 100Ω, but will increase harmonic distortion by approximately 2dB.

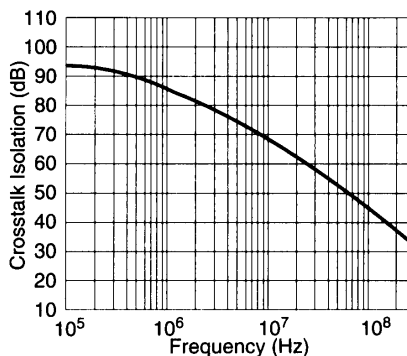

Figure 3: all-hostile crosstalk isolation

Crosstalk is strongly dependent on board layout. Closely spaced signal traces on the circuit board will degrade crosstalk due to intertrace capacitance. It is recommended that unused package pins (2,4,6,11) be connected to the ground plane for better isolation at the device pins. Similarly, crosstalk can be improved by using a grounded guard-trace between signal lines. This will reduce the distributed capacitance between signal lines.

Two graphs show the effects of crosstalk. All-hostile crosstalk is measured by driving three of the four buffers simultaneously while observing the fourth, undriven channel. Figure 3, "All-Hostile Crosstalk Isolation", shows this effect as a function of input signal frequency. The load for all four channels of the CLC115 is 100Ω. Figure 4, "Most Susceptible Channel-to-Channel Pulse Coupling", describes one effect of crosstalk when one channel is driven with a 4V_{pp} step ($t_r=5ns$) while the output of the undriven channel is measured. From Figure 3 it can be seen that crosstalk improves as the signal frequency is reduced. Similarly, the pulse coupling crosstalk will improve as the time increases.

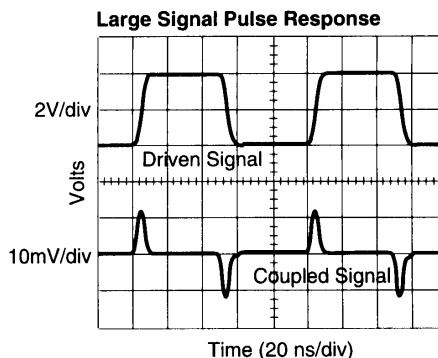

Figure 4: most susceptible channel-to-channel pulse coupling

Unused Buffers

The output of any unused buffers must be terminated in 100Ω to ground, as discussed above. It is recommended that unused buffer inputs be terminated in 50Ω to ground.

Evaluation Board

An evaluation board for the CLC115 is available. This board may be ordered as part CLC730023.

This page intentionally left blank.

Customer Design Applications Support

National Semiconductor is committed to design excellence. For sales, literature and technical support, call the National Semiconductor Customer Response Group at **1-800-272-9959** or fax **1-800-737-7018**.

Life Support Policy

National's products are not authorized for use as critical components in life support devices or systems without the express written approval of the president of National Semiconductor Corporation. As used herein:

1. Life support devices or systems are devices or systems which, a) are intended for surgical implant into the body, or b) support or sustain life, and whose failure to perform, when properly used in accordance with instructions for use provided in the labeling, can be reasonably expected to result in a significant injury to the user.
2. A critical component is any component of a life support device or system whose failure to perform can be reasonably expected to cause the failure of the life support device or system, or to affect its safety or effectiveness.



National Semiconductor Corporation

1111 West Bardin Road
Arlington, TX 76017
Tel: 1(800) 272-9959
Fax: 1(800) 737-7018

National Semiconductor Europe

Fax: (+49) 0-180-530 85 86
E-mail: europe.support.nsc.com
Deutsch Tel: (+49) 0-180-530 85 85
English Tel: (+49) 0-180-532 78 32
Francais Tel: (+49) 0-180-532 93 58
Italiano Tel: (+49) 0-180-534 16 80

National Semiconductor Hong Kong Ltd.

2501 Miramar Tower
1-23 Kimberley Road
Tsimshatsui, Kowloon
Hong Kong
Tel: (852) 2737-1600
Fax: (852) 2736-9960

National Semiconductor Japan Ltd.

Tel: 81-043-299-2309
Fax: 81-043-299-2408

National does not assume any responsibility for use of any circuitry described, no circuit patent licenses are implied and National reserves the right at any time without notice to change said circuitry and specifications.

This datasheet has been downloaded from:

www.DatasheetCatalog.com

Datasheets for electronic components.

National Semiconductor was acquired by Texas Instruments.

http://www.ti.com/corp/docs/investor_relations/pr_09_23_2011_national_semiconductor.html

This file is the datasheet for the following electronic components:

CLC115ALC - <http://www.ti.com/product/clc115alc?HQS=TI-null-null-dscatalog-df-pf-null-wwe>

CLC115AJP - <http://www.ti.com/product/clc115ajp?HQS=TI-null-null-dscatalog-df-pf-null-wwe>

CLC115AJE - <http://www.ti.com/product/clc115aje?HQS=TI-null-null-dscatalog-df-pf-null-wwe>

CLC114AJE - <http://www.ti.com/product/clc114aje?HQS=TI-null-null-dscatalog-df-pf-null-wwe>

CLC115AMC - <http://www.ti.com/product/clc115amc?HQS=TI-null-null-dscatalog-df-pf-null-wwe>



LittleDiode supplies new, hard to find or obsolete electronic components and semiconductors all over the world.

With over two million different components listed you are sure to find the part you need.

Feel free to visit us today at our online store:

LittleDiode.com

Looking forward to providing you with the best possible service.