

CLC114

Quad, Low-Power Video Buffer

General Description

The CLC114 is a high-performance, closed-loop quad buffer intended for power sensitive applications. Requiring only 30mW of quiescent power dissipation per channel ($\pm 5V$ supplies), the CLC114 offers a small signal bandwidth of 200MHz ($0.5V_{pp}$) and a slew rate of $450V/\mu s$.

Designed specifically for high density crosspoint switch and analog multiplexer applications, the CLC114 offers excellent linearity and wide channel isolation (62dB @ 10MHz). Driving a typical crosspoint switch load, the CLC114 offers differential gain and phase performance of 0.08% and 0.1%; gain flatness through 30MHz is typically 0.1dB.

With its patented closed-loop topology, the CLC114 has significant performance advantages over conventional open-loop designs. Applications requiring low output impedance and true unity gain stability through very high frequencies (active filters, dynamic load buffering, etc.) will benefit from the CLC114's superior performance.

Constructed using an advanced, complementary bipolar process and National's proven high-speed architectures, the CLC114 is available in several versions to meet a variety of requirements.

CLC114AJP	-40°C to +85°C	14-pin plastic DIP
CLC114AJE	-40°C to +85°C	14-pin plastic SOIC
CLC114ALC	-40°C to +85°C	dice
CLC114AMC	-55°C to +125°C	dice qualified to Method 5008, MIL-STD-883, Level B
CLC114A8B	-55°C to +125°C	14-pin CERDIP, MIL-STD-883, Level B

DESC SMD number: 5962-92339

Features

- Closed-loop, quad buffer
- 200MHz small-signal bandwidth
- $450V/\mu s$ slew rate
- Low power, 30mW per channel ($\pm 5V$ sup.)
- 62dB channel isolation (10MHz)
- Specified for crosspoint switch loads

Applications

- Video crosspoint switch driver
- Video distribution buffers
- Video switching buffers
- Video signaling multiplexing
- Instrumentation amps
- Active filters

Small Signal Pulse Response

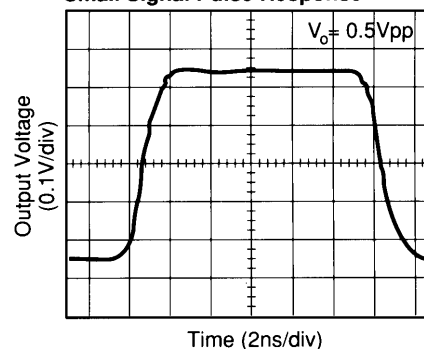

Typical Application

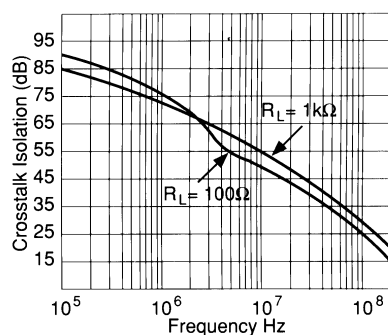

Pinout

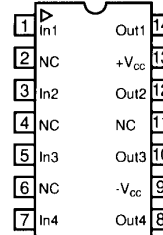

CLC114 Electrical Characteristics ($V_{CC} = \pm 5V, R_L = 100\Omega$ unless specified)

PARAMETERS	CONDITIONS	TYP	MAX & MIN RATINGS				UNITS	SYMBOL
			-40°C	+25°C	+85°C			
Ambient Temperature	CLC114AI	+25°C	-40°C	+25°C	+85°C			
FREQUENCY DOMAIN RESPONSE								
-3dB bandwidth	$V_{out} < 0.5V_{pp}$	200	>135	>135	>120	MHz	SSBW	
	$V_{out} < 2V_{pp}$	95	>70	>70	>70	MHz	LSBW	
gain flatness	$V_{out} < 0.5V_{pp}$							
peaking	DC to 30MHz	0.0	<0.3	<0.2	<0.3	dB	GFPL	
peaking	30MHz to 200MHz	0.0	<1.3	<0.7	<0.7	dB	GFPH	
rolloff	DC to 60MHz	0.1	<0.8	<0.8	<1.0	dB	GFR	
crosstalk (all hostile)	10MHz	62	>58	>58	>60	dB	XT	
TIME DOMAIN RESPONSE								
rise and fall time	0.5V step	1.8	<2.8	<2.8	<3.0	ns	TRS1	
	2V step	5	<7	<7	<8	ns	TRS2	
settling time to 0.1%	2V step	10	<15	<15	<20	ns	TS1	
to 0.01%	2V step	20	<30	<30	<40	ns	TS01	
overshoot	0.5V step	3	<15	<10	<15	%	OS	
slew rate		450	>180	>200	>180	V/ μ s	SR	
DISTORTION AND NOISE RESPONSE								
2nd harmonic distortion	$2V_{pp}, 20MHz$	-50	<-34	<-38	<-38	dBc	HD2	
3rd harmonic distortion	$2V_{pp}, 20MHz$	-58	<-50	<-50	<-45	dBc	HD3	
equivalent noise input								
noise floor	>1MHz	-155	<-153	<-153	<-153	dBm _{1Hz}	SNF	
STATIC, DC PERFORMANCE								
small signal gain	100 Ω load	0.97	>0.95	>0.96	>0.96	V/V	GA	
integral endpoint linearity	$\pm 1V$, full scale	0.4	<1.0	<0.6	<0.5	%	ILIN	
*output offset voltage		± 0.5	< ± 8.2	< ± 5.0	< ± 8.0	mV	VIO	
average temperature coefficient		± 9.0	< ± 40	—	< ± 30	μ V/ $^{\circ}C$	DVIO	
*input bias current		± 1.0	< ± 10	< ± 5	< ± 4	μ A	IBN	
average temperature coefficient		± 6.0	< ± 62	—	< ± 25	nA/ $^{\circ}C$	DIBN	
power supply rejection ratio		56	>48	>48	>46	dB	PSRR	
*supply current, total	no load, quiescent	12.0	<17.0	<16.5	<16.0	mA	ICC	
MISCELLANEOUS PERFORMANCE								
input resistance		1.5	>0.3	>1.0	>2.0	M Ω	RIN	
input capacitance		1.8	<3.5	<3.0	<3.5	pF	CIN	
output impedance	DC	2.5	<5.0	<3.5	<3.5	Ω	RO	
output voltage range	no load	± 4.0	> ± 3.6	> ± 3.8	> ± 3.8	V	VO	
output current		25	>12	>20	>25	mA	IO	

Performance Driving a Crosspoint Switch

PARAMETERS	CONDITIONS	TYP	UNITS
gain flatness	$V_{out} < 2V_{pp}$ DC to 5MHz	± 0.02	dB
	$V_{out} < 2V_{pp}$ DC to 30MHz	± 0.1	dB
differential gain	3.58 & 4.43MHz	0.08	%
differential phase	3.58 & 4.43MHz	0.1	$^{\circ}$
2 nd harmonic distortion	5MHz, $2V_{pp}$	-60	dBc
	30MHz, $2V_{pp}$	-43	dBc
3 rd harmonic distortion	5MHz, $2V_{pp}$	-58	dBc
	30MHz, $2V_{pp}$	-43	dBc
crosstalk (all hostile)	5MHz	58	dB
	10MHz	54	dB
	30MHz	42	dB

Min/max ratings are based on product characterization and simulation. Individual parameters are tested as noted. Outgoing quality levels are determined from tested parameters.

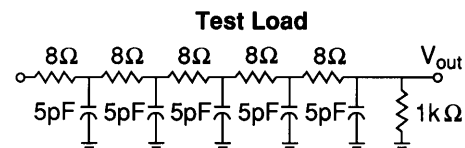

Absolute Maximum Ratings

Miscellaneous Ratings

V_{CC}	$\pm 7V$
I_{out}	output is short circuit protected to ground, but maximum reliability will be maintained if I_{out} does not exceed... 30mA
input voltage	$\pm V_{CC}$
maximum junction temperature	+150°C
operating temperature range	
AJ:	-40°C to +85°C
storage temperature range	-65°C to +150°C
lead temperature (soldering 10 sec)	+300°C
EDS rating	500V

NOTES:

* AJ 100% tested at +25°C.

Package Thermal Resistance

Package	θ_{JC}	θ_{JA}
Plastic (AJP)	65°C/W	115°C/W
Surface Mount (AJE)	55°C/W	125°C/W
CERDIP	35°C/W	90°C/W

Reliability Information

Transistor Count

64

CLC114 Typical Performance Characteristics

Gain and Phase vs. Load

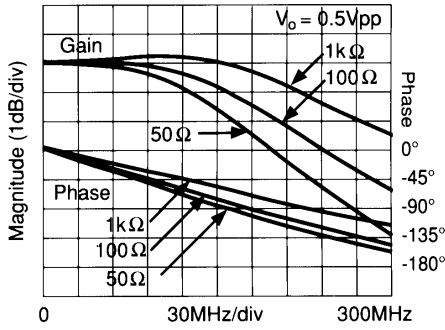

Output Impedance

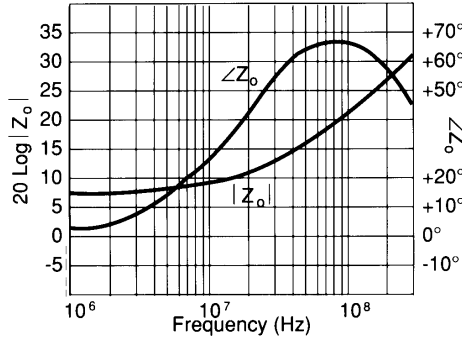

Input Impedance

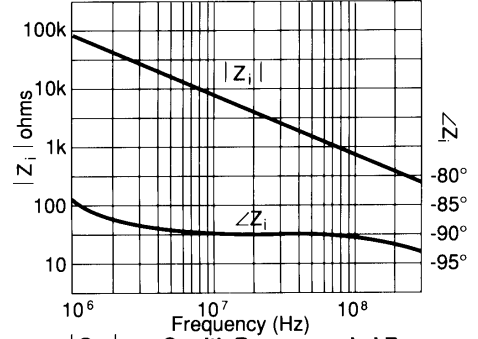

PSRR

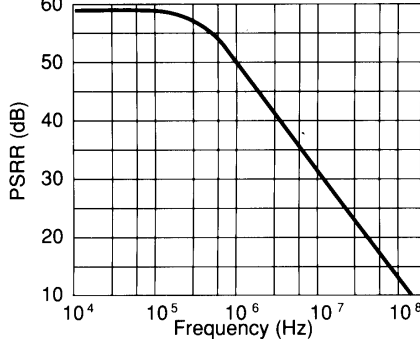

Recommended R_s vs. Load Capacitance

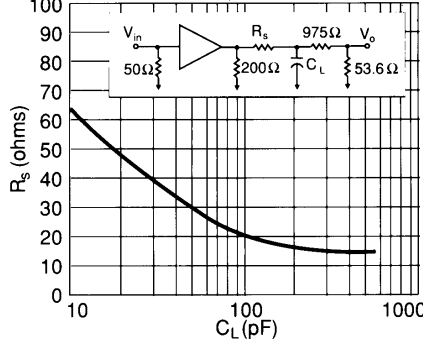

|S₂₁| vs. C_L with Recommended R_s

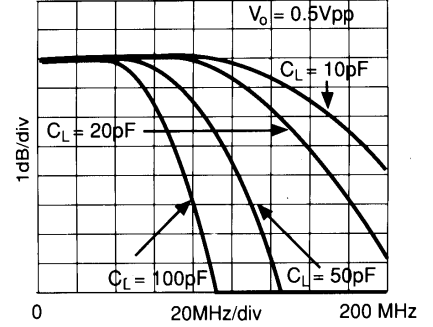

Small Signal Pulse Response

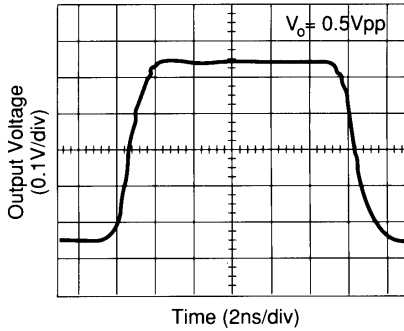

Large Signal Pulse Response

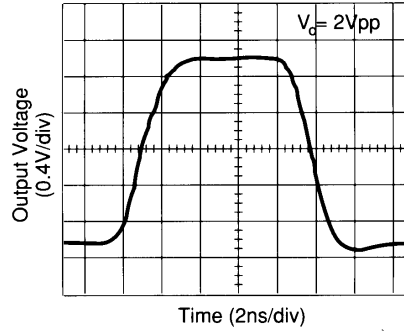

Short-Term Settling Time

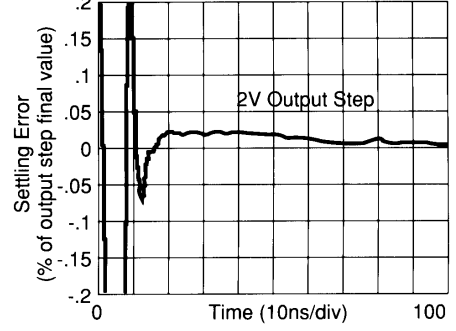

Integral Linearity Error

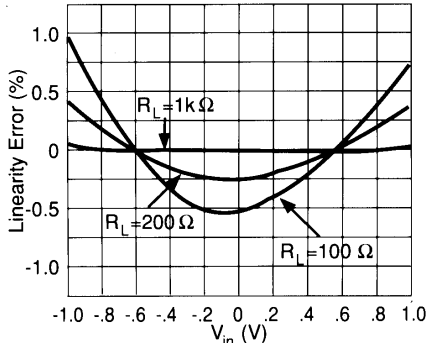

Output Current vs. Temperature

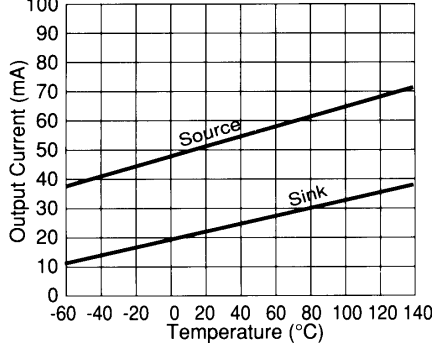

Typical D.C. Errors vs. Temperature

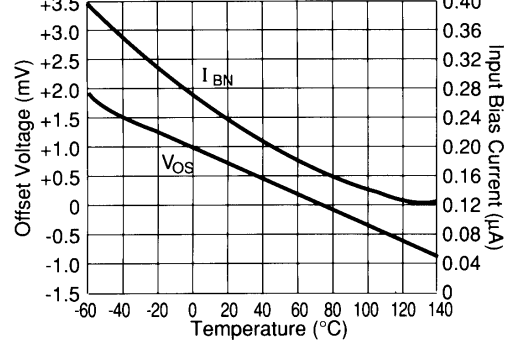

Equivalent Input Noise

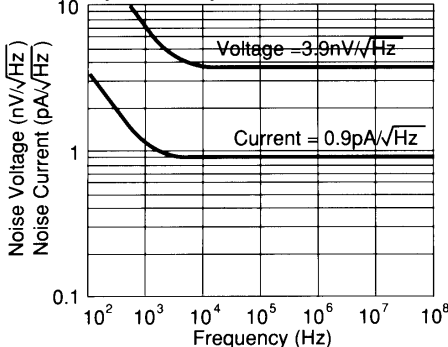

2nd and 3rd Harmonic Distortion

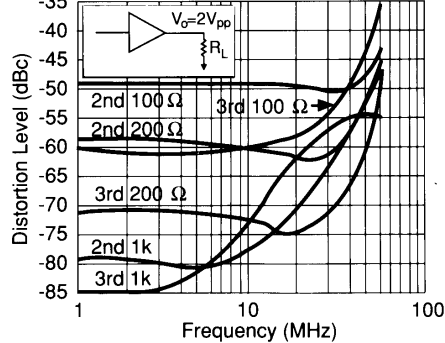

2-Tone, 3rd Order Intermodulation Intercept

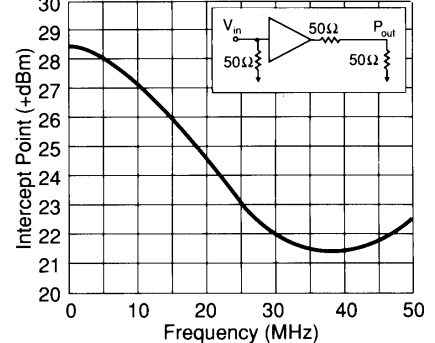

Operation

The CLC114 is a quad, low-power, high-speed, unity-gain buffer. The closed loop topology provides accuracy not found in open loop designs. The input stage incorporates a slew-enhancement circuit which allows low quiescent power without sacrificing ac performance.

PC Board Layout and Crosstalk

High frequency devices demand a good printed circuit board layout for optimum performance. The CLC114, with power gain to 200 MHz, is no exception. A ground plane and power supply bypassing with good high-frequency ceramic capacitors in close proximity to the supply pins is essential. Second harmonic distortion can be improved by ensuring equal current return paths for both the positive and the negative supplies. This can be accomplished by grounding the bypass capacitors at the same point in the ground plane while keeping the power supply side of the bypass capacitors within 0.1" of the CLC114 supply pins.

Crosstalk (undesired signal coupling between buffer channels) is strongly dependent on board layout. Closely spaced signal traces on the circuit board will degrade crosstalk due to intertrace capacitance. For this reason it is recommended that unused package pins (2, 4, 6, 11) be connected to the ground plane for better channel isolation at the device pins. Similarly, crosstalk can be improved by using a grounded guard trace between signal traces. This will reduce the distributed capacitance between signal lines.

Following are two graphs depicting the effects of crosstalk. All-hostile crosstalk is measured by driving three of the four buffers simultaneously while observing the fourth, undriven, channel. Figure 2, "All-Hostile Crosstalk Isolation", shows this effect as a function of input signal frequency. R_L is the resistive load for each driven channel. Figure 3, "Most Susceptible Channel-to-Channel Pulse Coupling", describes one effect of crosstalk when one channel is driven with a 2Vpp step ($t_r=5ns$) while the output of the undriven channel is measured. From Figure 2 it can be observed that crosstalk decreases as the signal frequency is reduced. Similarly, the pulse coupling crosstalk will decrease as the rise time increases.

Evaluation Board

An evaluation board for the CLC114 is available. This board may be ordered as part CLC730023.

Unused Buffers

It is recommended that the inputs of any unused buffers be tied to ground through 50Ω resistors.

Differential Gain and Phase

The CLC114 was designed to minimize differential gain and phase errors when driving the distributed capacitance of a video crosspoint switch. Refer to the section "Performance Driving a Crosspoint Switch" for typical values.

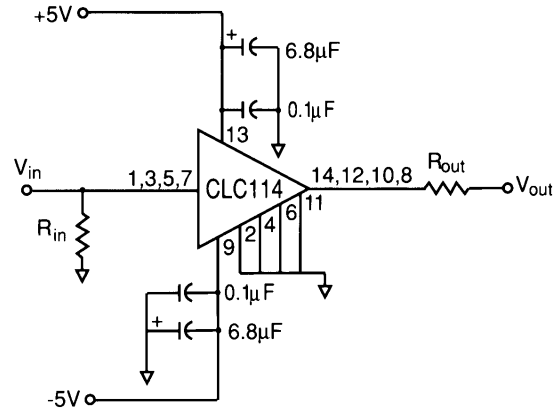

Figure 1: Recommended Circuit

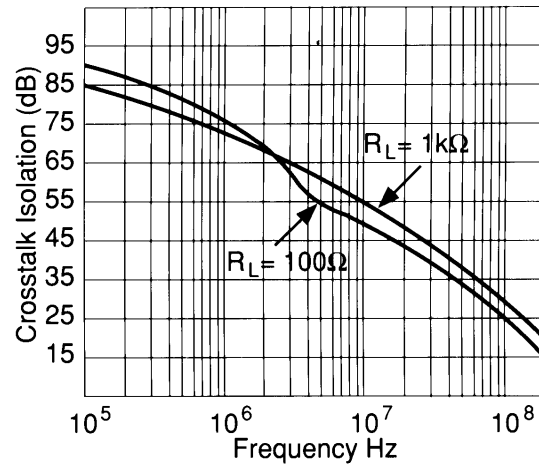

Figure 2: All-Hostile Crosstalk Isolation

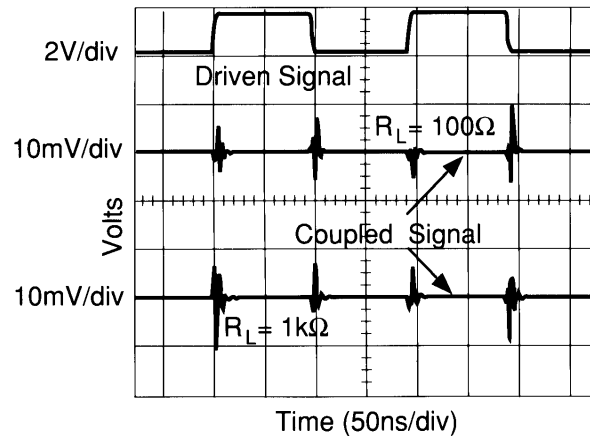

Figure 3: Most Susceptible Channel-to-Channel Pulse Coupling

This page intentionally left blank.

Customer Design Applications Support

National Semiconductor is committed to design excellence. For sales, literature and technical support, call the National Semiconductor Customer Response Group at **1-800-272-9959** or fax **1-800-737-7018**.

Life Support Policy

National's products are not authorized for use as critical components in life support devices or systems without the express written approval of the president of National Semiconductor Corporation. As used herein:

1. Life support devices or systems are devices or systems which, a) are intended for surgical implant into the body, or b) support or sustain life, and whose failure to perform, when properly used in accordance with instructions for use provided in the labeling, can be reasonably expected to result in a significant injury to the user.
2. A critical component is any component of a life support device or system whose failure to perform can be reasonably expected to cause the failure of the life support device or system, or to affect its safety or effectiveness.



National Semiconductor Corporation

1111 West Bardin Road
Arlington, TX 76017
Tel: 1(800) 272-9959
Fax: 1(800) 737-7018

National Semiconductor Europe

Fax: (+49) 0-180-530 85 86
E-mail: europe.support.nsc.com
Deutsch Tel: (+49) 0-180-530 85 85
English Tel: (+49) 0-180-532 78 32
Francais Tel: (+49) 0-180-532 93 58
Italiano Tel: (+49) 0-180-534 16 80

National Semiconductor Hong Kong Ltd.

2501 Miramar Tower
1-23 Kimberley Road
Tsimshatsui, Kowloon
Hong Kong
Tel: (852) 2737-1600
Fax: (852) 2736-9960

National Semiconductor Japan Ltd.

Tel: 81-043-299-2309
Fax: 81-043-299-2408

National does not assume any responsibility for use of any circuitry described, no circuit patent licenses are implied and National reserves the right at any time without notice to change said circuitry and specifications.

This datasheet has been downloaded from:

www.DatasheetCatalog.com

Datasheets for electronic components.

National Semiconductor was acquired by Texas Instruments.

http://www.ti.com/corp/docs/investor_relations/pr_09_23_2011_national_semiconductor.html

This file is the datasheet for the following electronic components:

CLC114A8B - <http://www.ti.com/product/clc114a8b?HQS=TI-null-null-dscatalog-df-pf-null-ww>

CLC114AMC - <http://www.ti.com/product/clc114amc?HQS=TI-null-null-dscatalog-df-pf-null-ww>

CLC111AMC - <http://www.ti.com/product/clc111amc?HQS=TI-null-null-dscatalog-df-pf-null-ww>

CLC114ALC - <http://www.ti.com/product/clc114alc?HQS=TI-null-null-dscatalog-df-pf-null-ww>



LittleDiode supplies new, hard to find or obsolete electronic components and semiconductors all over the world.

With over two million different components listed you are sure to find the part you need.

Feel free to visit us today at our online store:

LittleDiode.com

Looking forward to providing you with the best possible service.