

# HA13471A, HA13472A

## Three-Phase Motor Drive with Speed Discriminator

### Description

HA13471A and HA13472A are three-phase brushless DC motor drive IC of 2A/phase and 4A/phase and have following functions.

### Features

- Soft switching (No spike voltage at commutation)
- Snubberless
- Large current capability
  - 2A/phase (HA13471A)
  - 4A/phase (HA13472A)
- High efficiency. Low noise driving

### Functions

- Three phase output circuit
- Hall amp, Matrix with AGC
- Neutral point feed back
- Direction
- Output inhibit
- Oscillation circuit
- Mode select (1/4, 1/2, 1/1)
- Speed discriminator
- Integrator
- Control amp
- Current limiter
- Low voltage inhibit (LVI)
- Over temperature shutdown circuit (OTSD)

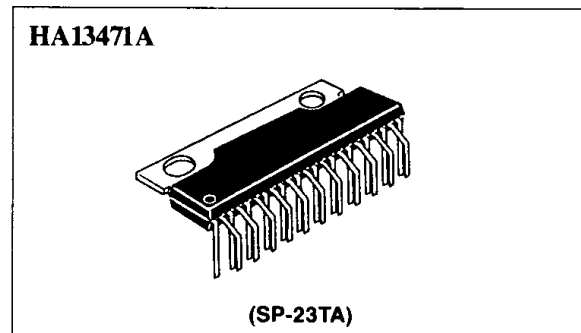

### Pin Arrangement

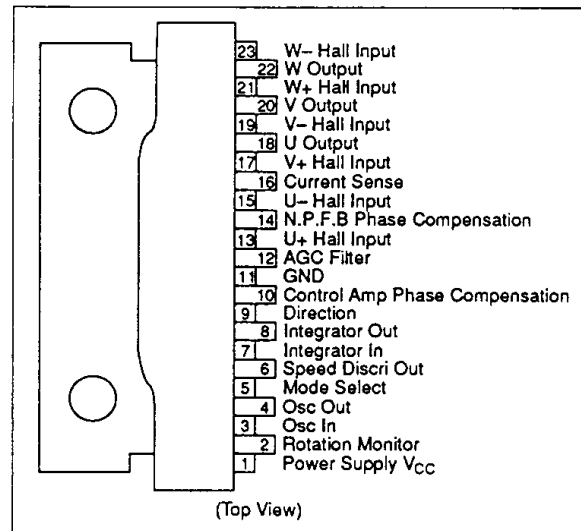

### Ordering Information

Type No.	Package
HA13471A	SP-23TA
HA13472A	SP-23TA

Block Diagram

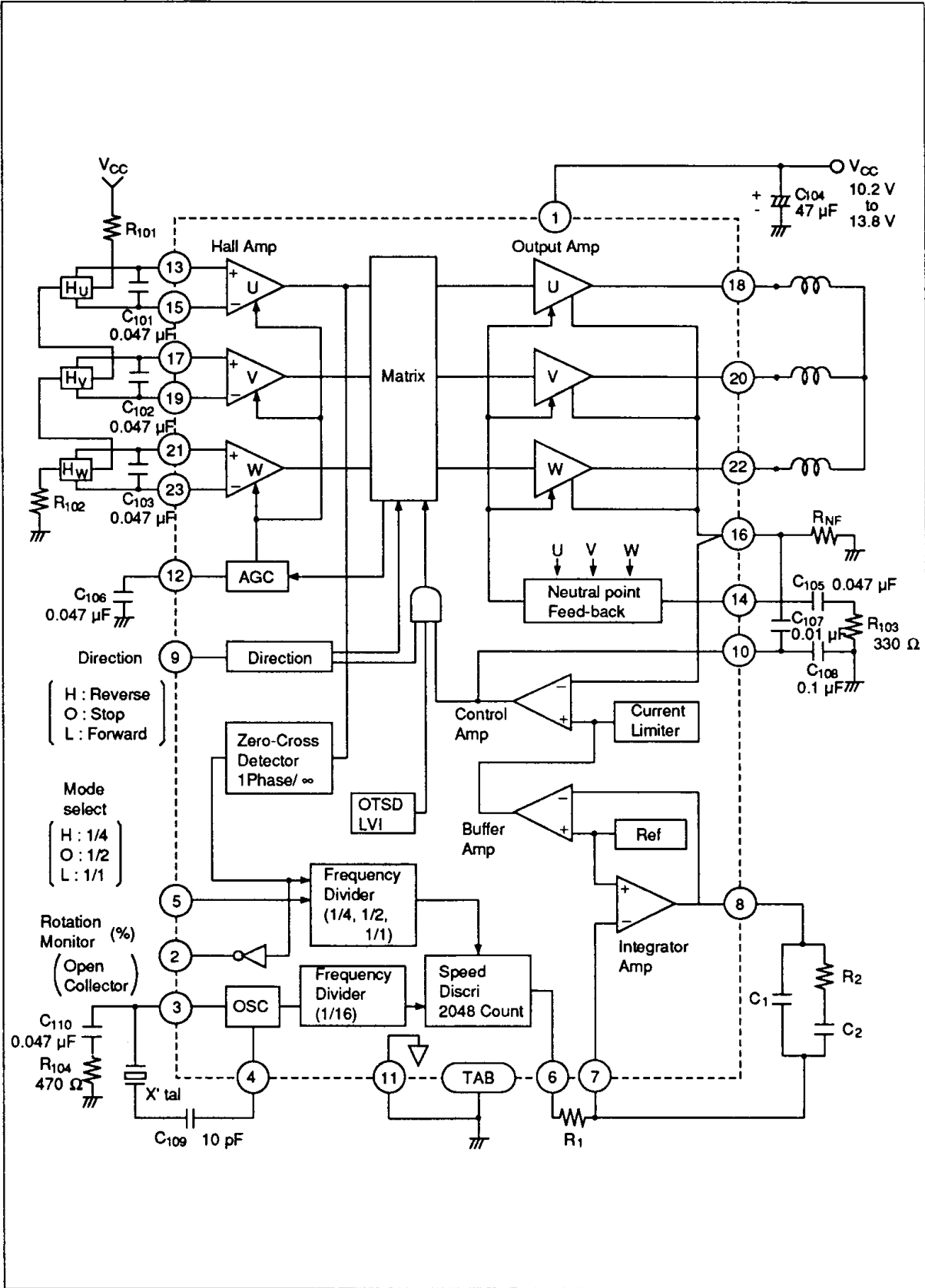

# HA13471A, HA13472A

## Absolute Maximum Ratings (Ta = 25°C)

Item	Symbol	Rating		Unit	Notes
		HA13471A	HA13472A		
Supply Voltage	V <sub>CC</sub>	+15	+15	V	1
Input Voltage	V <sub>in</sub>	V <sub>CC</sub>	V <sub>CC</sub>	V	2
Output Current	I <sub>O</sub>	2	4	A	3
Power Dissipation	P <sub>T</sub>	15 (at T <sub>C</sub> = 105°C)	30 (at T <sub>C</sub> = 60°C)	W	4
Junction Temperature	T <sub>j</sub>	150	150	°C	5
Storage Temperature	T <sub>stg</sub>	-55 to +125	-55 to +125	°C	

The absolute maximum ratings are limiting values, to be applied individually, beyond which the device may be permanently damaged. Functional operation under any of these conditions is not guaranteed. Exposing a circuit to its absolute maximum rating for extended periods of time may affect the device's reliability.

- Notes:
1. Operating voltage range is 12 V ±15% (10.2 ~ 13.8 V)
  2. Applied to Hall amp, Direction and Mode select Input
  3. ASO of each power transistor is shown below. Operating locus must be within the ASO

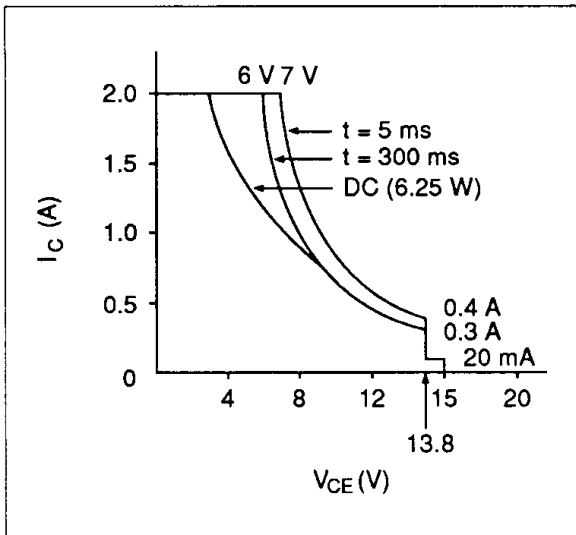

Figure 1 HA13471A

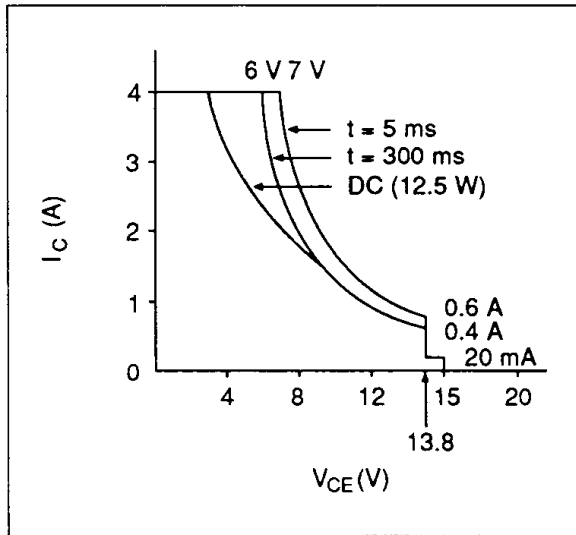

Figure 2 HA13472A

4. Thermal resistance is shown below
  - $\theta_{j-c} \leq 3^\circ\text{C/W}$
  - $\theta_{j-a} \leq 40^\circ\text{C/W}$
5. The operating junction temperature range is T<sub>opr</sub> = 0°C to 125°C

Electrical Characteristics (Ta = 25°C, VCC = 12 V)

Item	Symbol	Min	Typ	Max	Unit	Test Conditions	Pins	Notes	
Dissipation current	$I_{CC}$	—	22	33	mA		1		
Hall amp	Input impedance	$R_{Hi}$	7	10	15	k $\Omega$	13, 15, 17,		
	Common mode voltage range	$V_H$	2.5	—	$V_{CC}$ -2.5	V	19, 21, 23	4	
	Differential voltage range	$v_h$	75	—	300	mV			
Output amp	Leak current	$I_{CER}$	—	—	2	mA	$V_{CE} = 15 V$	18, 20, 22	
	Saturation voltage	$V_{sat1}$	—	2.8	3.2	V	$I_O = 3.0 A (1.5 A)$		1
		$V_{sat2}$	—	1.7	2.0	V	$I_O = 0.6 A (0.3 A)$		1
Current limiter	Internal reference voltage	$V_{ref1}$	0.225	0.25	0.275	V	$R_{NF} = 1.0 \Omega$	16	
Buffer amp	Internal reference voltage	$V_{ref2}$	$V_{CC}/2$ -10%	$V_{CC}/2$	$V_{CC}/2$ +10%	V		7	
	Voltage gain	$G_{CTL}$	-2	0	+2	dB	Pin 8 to Pin 16	16	
Integrating amp	Input bias current	$I_B(ER)$	—	—	$\pm 60$	nA		7	
	Voltage swing	A <sup>+</sup>	0.55	0.7	0.85	V	$I_O = 0.5 mA$	8	2
		A <sup>-</sup>	-0.55	-0.7	-0.85	V	$I_O = -0.5 mA$		2
	Band width	BW	—	1.4	—	MHz	$G_V = 0 dB$		3
Speed discriminator	Output high voltage	$V_{OH}$	$V_{CC}$ -0.3	—	—	V	$I_O = 0.5 mA$	6	
	Output low voltage	$V_{OL}$	—	—	0.2	V	$I_O = -0.5 mA$		
	Cutoff current	$I_{off}$	—	—	$\pm 60$	nA			
	Count number		—	2048	—				
Oscillator	Frequency error	$f_{err}$	—	—	$\pm 0.1$	%	X <sup>1al</sup> $f_{osc} = 8.0 MHz$	4	
	Operating frequency	$f_{osc}$	—	—	8	MHz	X <sup>1al</sup>		
Direction	Input high voltage	$V_{IH}$	3.6	—	—	V	Reverse	9	
	Input middle voltage	$V_{IM}$	2.2	—	2.8	V	Stop		
	Input low voltage	$V_{IL}$	—	—	1.4	V	Forward		
	Input high current	$I_{IH}$	—	0.54	0.8	mA	$V_H = 5.5 V$		
	Input low current	$I_{IL}$	—	-0.54	-0.8	mA	$V_L = 0.0 V$		
Driver	Input high voltage	$V_{IH2}$	3.6	—	—	V	Ratio; 1/4	5	
	Input middle voltage	$V_{IN2}$	2.2	—	2.8	V	Ratio; 1/2		
	Input low voltage	$V_{IL2}$	—	—	1.4	V	Ratio; 1/1		
	Input high current	$I_{IH2}$	—	0.54	0.8	mA	$V_{H2} = 5.5 V$		
	Input low current	$I_{IL2}$	—	-0.54	-0.8	mA	$V_{L2} = 0.0 V$		

# HA13471A, HA13472A

## Electrical Characteristics (Ta = 25°C, V<sub>CC</sub> = 12 V) (cont)

Item	Symbol	Min	Typ	Max	Unit	Test Conditions	Pins	Notes
Rotation monitor	Output leak current	$I_{CER2}$	—	—	100	$\mu A$	$V_{CE} = 15 V$	2
	Output low voltage	$V_{OL2}$	—	—	0.4	V	$I_O = 1 mA$	
LVI operating voltage		—	—	8.0	V			
OTSD operating temperature		$T_{sd}$	125	150	—	$^{\circ}C$		3

- Notes:
1. Sum of upper and lower saturation voltage.
  2. Measure from  $V_{ref2}$
  3. Design guide only
  4. Operating area for  $V_H$  and  $v_h$  is shown below

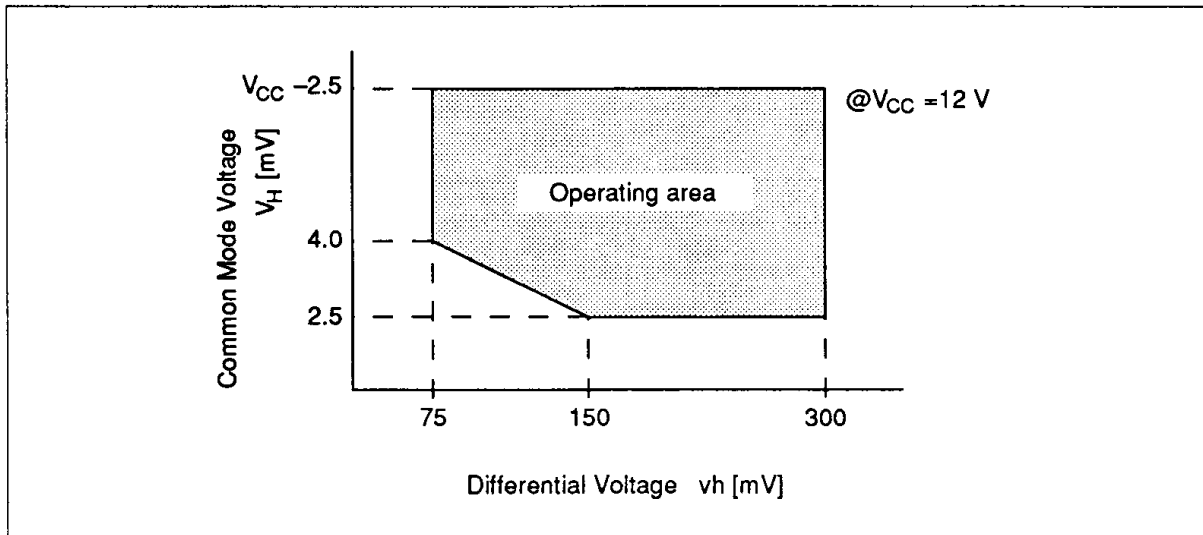

**Figure 3 Hallamp Operating Area**

Timing Chart

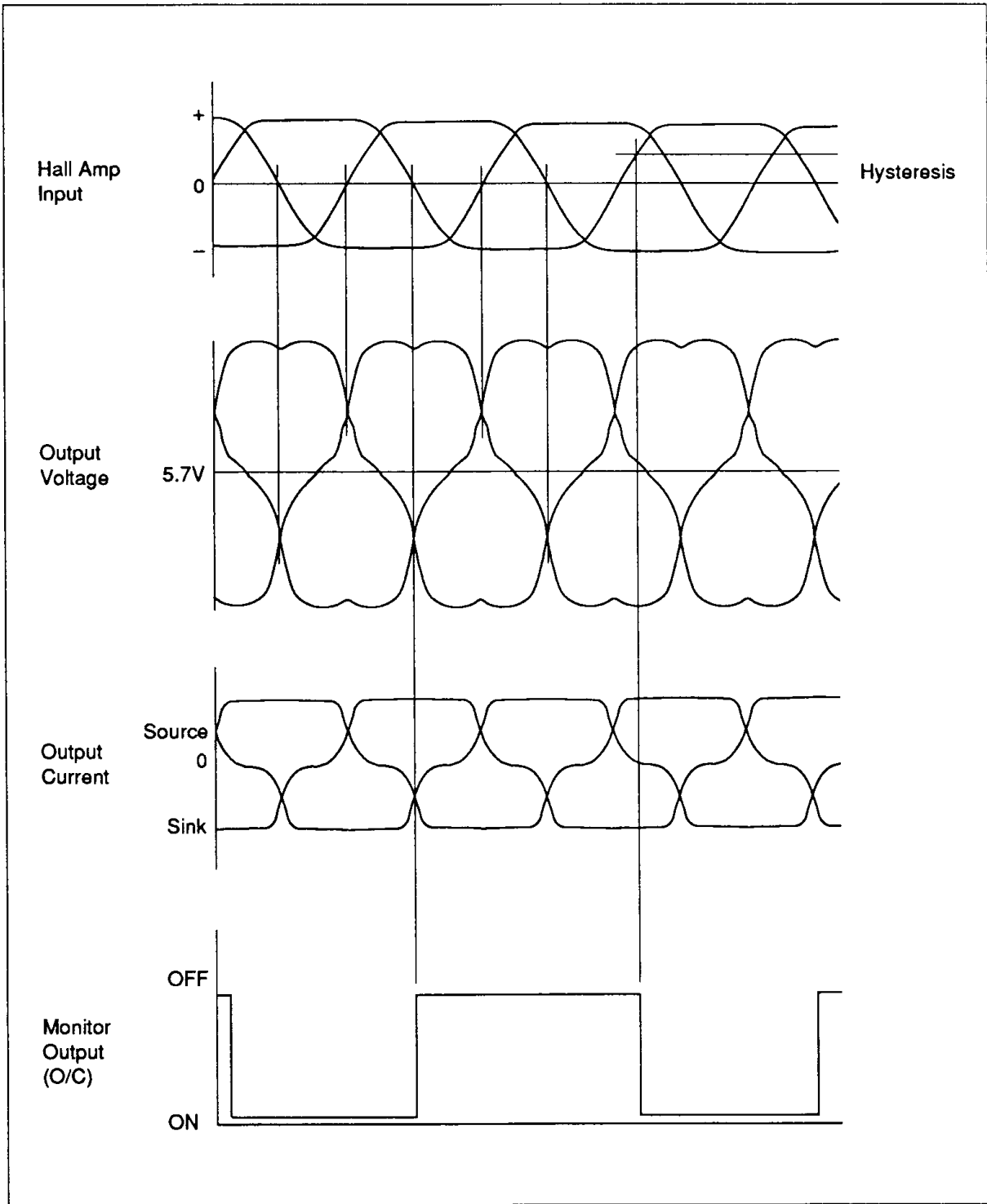

# HA13471A, HA13472A

## External Components

Parts No.	Recommended value		Purpose	Notes
	HA13471A 3.5" × 2 disks	HA13472A 5.25" × 6 disks		
R <sub>101</sub> , R <sub>102</sub>	560 Ω	560 Ω	Hall element bias	1
R <sub>103</sub>	330 Ω	330 Ω	Stability	
R <sub>104</sub>	470 Ω	470 Ω	Oscillation stability	2
R <sub>1</sub>	470 kΩ	68 kΩ	Integral constant	3
R <sub>2</sub>	560 kΩ	560 kΩ		
R <sub>NF</sub>	0.33 Ω × 2 para	0.33 Ω × 4 para	Current detector	4
C <sub>101</sub> , C <sub>102</sub> , C <sub>103</sub>	0.047 μF	0.047 μF	Stability	
C <sub>104</sub>	≥ 47 μF	≥ 47 μF	By-pass	
C <sub>105</sub>	0.047 μF	0.047 μF	NPF phase compensation	
C <sub>106</sub>	0.047 μF	0.047 μF	AGC filter	
C <sub>107</sub>	0.01 μF	0.01 μF	CTL Amp	
C <sub>108</sub>	0.1 μF	0.1 μF	Phase compensation	
C <sub>109</sub>	10 pF ±1%	10 pF ±1%	AC-coupling	
C <sub>110</sub>	0.047 μF	0.047 μF	Stability	2
C <sub>1</sub>	0.022 μF	0.022 μF	Integral constant	3
C <sub>2</sub>	0.22 μF	0.22 μF		
D <sub>1</sub> , D <sub>2</sub> , D <sub>3</sub>	—	—	Output clamp	5
X <sup>tal</sup>	—	—	Oscillator	6

- Notes:
1. Set R<sub>101</sub>, R<sub>102</sub> in order to get Hall element output within 75 to 300 mV<sub>pp</sub>
  2. Unnecessary below 4 MHz frequency
  3. The optimum value depends on the motor (Inertia, Torque constant Rotation)
  4. Output Current is limited as shown below  

$$I_{omax} = V_{ref1}/R_{NF}$$
  5. It must be noted that some motors requires protection for speed discriminator misoperation
  6. OSC frequency f<sub>osc</sub> is determined by following equation

$$f_{osc} = \frac{16 \times 2048 \times f_H}{m}$$

$$= \frac{16 \times 2048}{m} \times \frac{No}{60} \times \frac{P}{2} \text{ (Hz)}$$

Where

f <sub>H</sub>	:	frequency of hall amp input signal
No	:	rotation Number
P	:	pole Number
m	:	frequency divider constant
		m = 1 (@ Pin 5 = Low)
		= 2 (@ Pin 5 = Open)
		= 4 (@ Pin 5 = High)

In case of large jitter of hall amp input signal, select divider constant m as follows

4 pole motor → m = 2

8 pole motor → m = 4



This datasheet has been downloaded from:

[www.DatasheetCatalog.com](http://www.DatasheetCatalog.com)

Datasheets for electronic components.



LittleDiode supplies new, hard to find or obsolete electronic components and semiconductors all over the world.

With over two million different components listed you are sure to find the part you need.

Feel free to visit us today at our online store:

[LittleDiode.com](http://LittleDiode.com)

Looking forward to providing you with the best possible service.