

Am25LS23

8-Bit Shift/Storage Register with Synchronous Clear

DISTINCTIVE CHARACTERISTICS

- Synchronous clear
- Three-state outputs
- Common input/output pins
- Cascadable shifting
- Second sourced by T.I. as 54LS/74LS323

GENERAL DESCRIPTION

The Am25LS23 is an 8-bit universal shift/storage register with 3-state outputs. The function is similar to the Am25LS299 with the exception of a synchronous clear function. Parallel load inputs and register outputs are multiplexed to allow the use of a 20-pin package. Separate

continuous outputs are also provided for flip-flops Q_0 and Q_7 .

Four modes of operation are possible – Hold (store), Shift-left, Shift-right and Load Data. The Am25LS23 has a typical shift frequency of 50MHz. The Am25LS23 is packaged in a standard 20-pin package.

BLOCK DIAGRAM

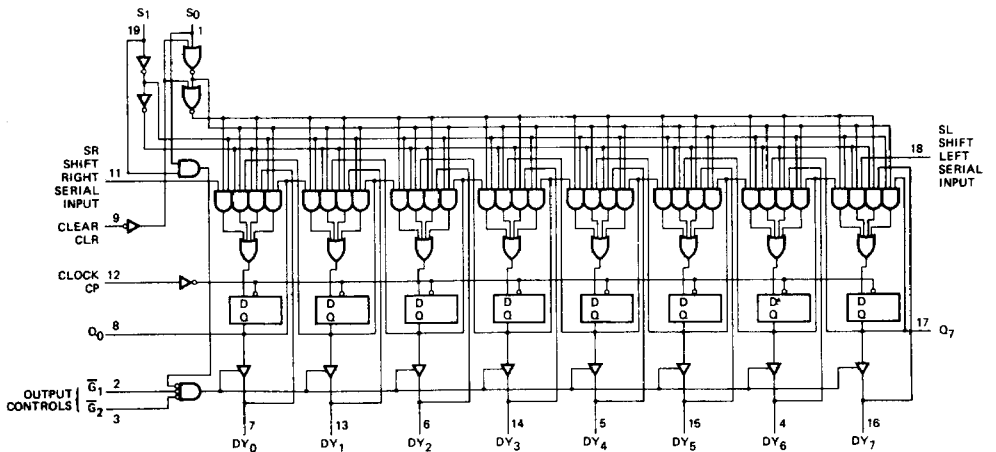

RELATED PRODUCTS

Part No.	Description
Am25LS22	8-Bit Serial/Parallel Register

CONNECTION DIAGRAM Top View

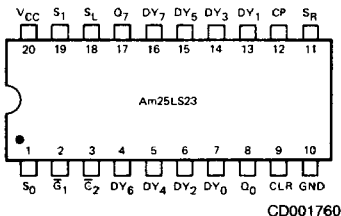

Note: Pin 1 is marked for orientation

LOGIC SYMBOL

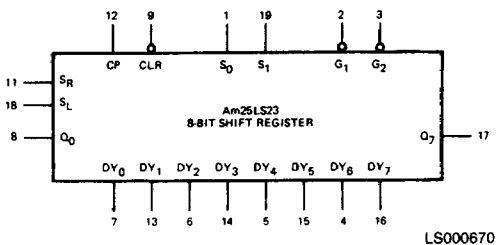

METALLIZATION AND PAD LAYOUT

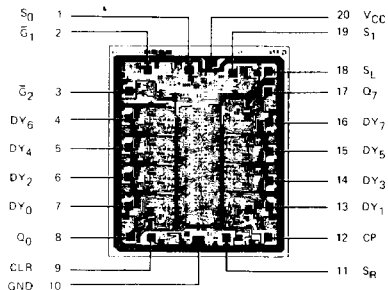

ORDERING INFORMATION

AMD products are available in several packages and operating ranges. The order number is formed by a combination of the following: Device number, speed option (if applicable), package type, operating range and screening option (if desired).

Am25LS23

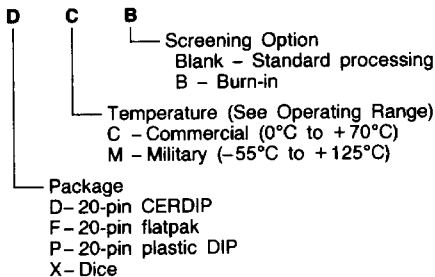

Device type
8-Bit Shift Storage Register
With Synchronous Clear

Valid Combinations	
Am25LS23	PC DC, DM FM XC, XM

Valid Combinations

Consult the AMD sales office in your area to determine if a device is currently available in the combination you wish.

PIN DESCRIPTION

Pin No.	Name	I/O	Description
11	S _R	I	Shift right data input to Q ₇ .
18	S _L	I	Shift left data input to Q ₀ .
9	Clear	I	Active LOW synchronous input forcing the Q ₀ through Q ₇ register to see LOW conditions, visible only if outputs are enabled.
12	Clock	I	A LOW-to-HIGH transition will result in the register changing state to next state as described by mode and input data condition.
1, 19	S ₀ , S ₁	I	Mode selection control lines used to control input (output during load) conditions.
2, 3	G ₁ , G ₂	I	Active LOW input to control three-state output in active LOW AND configuration.
8, 17	Q ₀ , Q ₇	O	The only two direct outputs; used to cascade shift operations.
7, 13, 6, 14, 5, 15, 4, 16	DY ₀ - DY ₇	I/O	Input/Output line dependent on mode and output control. Input only with mode select LOAD. Output in all other modes but subject to output select (G ₁ , G ₂).

TRUTH TABLE

FUNCTION		INPUTS						OUTPUTS		INPUTS/OUTPUTS									
		S _R	S _L	CLEAR	CLOCK	S ₀	S ₁	G ₁	G ₂	Q ₀	Q ₇	DY ₀	DY ₁	DY ₂	DY ₃	DY ₄	DY ₅	DY ₆	DY ₇
Clear		X	X	L	↑	(Note 1)	L	L	L	L	L	L	L	L	L	L	L	L	L
Output Control		X	X	X	X	X	X	X	H	L	NC	NC	Z	Z	Z	Z	Z	Z	Z
		X	X	X	X	X	X	X	H	H	NC	NC	Z	Z	Z	Z	Z	Z	Z
M O D E	Hold Load (Note 2)	X	X	H	X	L	L	L	L	NC	NC	NC	NC	NC	NC	NC	NC	NC	NC
	Shift Right	X	X	H	↑	H	H	L	L	A	H	A	B	C	D	E	F	G	H
	Shift Right	L	X	H	↑	H	L	L	L	L	L	L	L	L	L	L	L	L	L
	Shift Left	H	X	H	↑	H	L	L	L	H	DY ₆	H	DY ₀	DY ₁	DY ₂	DY ₃	DY ₄	DY ₅	DY ₆
E	Shift Left	X	L	H	↑	L	L	L	L	DY ₁	L	DY ₁	DY ₂	DY ₃	DY ₄	DY ₅	DY ₆	DY ₇	L
	Shift Left	X	H	H	↑	L	H	L	L	DY ₁	H	DY ₁	DY ₂	DY ₃	DY ₄	DY ₅	DY ₆	DY ₇	H

L = LOW Z = High Impedance ↑ = Transition LOW-to-HIGH
H = HIGH X = Don't Care NC = No Change

Notes: 1. Either LOW to observe outputs.
2. In this mode DY₁ are inputs.

APPLICATION

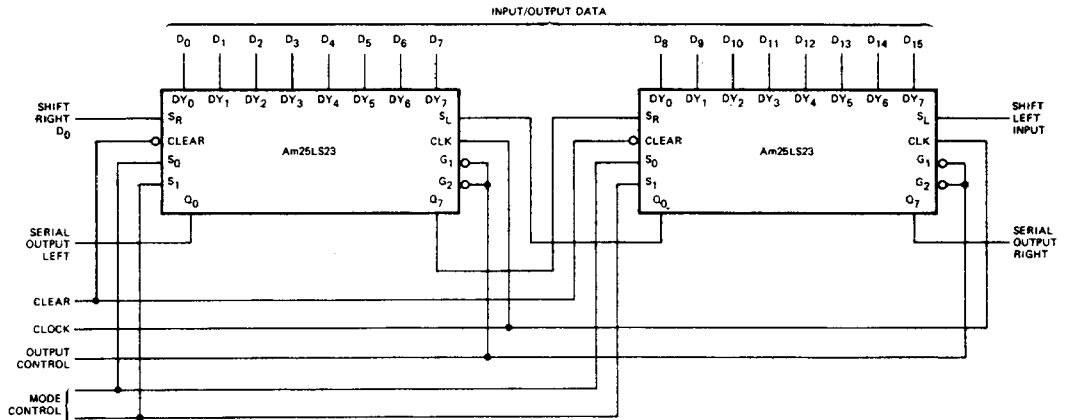

AF001110

16-Bit Cascaded Parallel Load/Unload Shift Right/Left Register.

ABSOLUTE MAXIMUM RATINGS

Storage Temperature -65°C to +150°C
 (Ambient) Temperature Under Bias ... -55°C to +125°C
 Supply Voltage to Ground Potential
 Continuous -0.5V to +7.0V
 DC Voltage Applied to Outputs For
 HIGH Output State -0.5V to +V_{CC} max
 DC Input Voltage S₀, S₁, \bar{G} ₁, \bar{G} ₂,
 CLR, CP) -0.5V to +7.0V
 DC Input Voltage (Others) -0.5V to +5.5V
 DC Output Current, Into Outputs 30mA
 DC Input Current -30mA to +5.0mA

Stresses above those listed under ABSOLUTE MAXIMUM RATINGS may cause permanent device failure. Functionality at or above these limits is not implied. Exposure to absolute maximum ratings for extended periods may affect device reliability.

OPERATING RANGES

Commercial (C) Devices
 Temperature 0°C to +70°C
 Supply Voltage +4.75V to +5.25V
 Military (M) Devices
 Temperature -55°C to +125°C
 Supply Voltage +4.5V to +5.5V
Operating ranges define those limits over which the functionality of the device is guaranteed.

DC CHARACTERISTICS over operating range unless otherwise specified

Parameters	Description	Test Conditions (Note 2)		Min	Typ (Note 1)	Max	Units	
V _{OH}	Output HIGH Voltage	V _{CC} = MIN. V _{IN} = V _{IH} or V _{OL}	Q ₀ , Q ₇	I _{OH} = -440μA	MIL	2.5		Volts
					COM'L	2.7		
		DY ₀ -DY ₇	MIL, I _{OH} = -1.0mA		2.4			
			COM'L, I _{OH} = -2.6mA		2.4			
V _{OL}	Output LOW Voltage	V _{CC} = MIN. V _{IN} = V _{IH} or V _{IL}		I _{OL} = 4.0mA		0.25	0.4	Volts
					I _{OL} = 8.0mA		0.35	
V _{IH}	Input HIGH Level	Guaranteed input logical HIGH voltage for all inputs		2.0			Volts	
V _{IL}	Input LOW Level	Guaranteed input logical LOW voltage for all inputs			MIL	0.7	Volts	
					COM'L	0.8		
V _I	Input Clamp Voltage	V _{CC} = MIN., I _{IN} = -18mA				-1.5	Volts	
I _{IL}	Input LOW Current	V _{CC} = MAX., V _{IN} = 0.4V		S ₀ , S ₁			-0.8	mA
				All others			-0.4	
I _{IH}	Input HIGH Current	V _{CC} = MAX., V _{IN} = 2.7V (Except DY _i)		S ₀ , S ₁			40	μA
				All others			20	
I _I	Input HIGH Current	V _{CC} = MAX., (Except DY _i)	V _{IN} = 7V	S ₀ , S ₁			0.2	mA
				\bar{G} ₁ , \bar{G} ₂ , CLR, CP			0.1	
			V _{IN} = 5.5V	Others			0.1	
I _{OZ}	Off-State (High Impedance) Output Current	V _{CC} = MAX.		V _O = 0.4V			-100	μA
				V _O = 2.4V			40	
I _{SC}	Output Short Circuit Current (Note 3)	V _{CC} = MAX.		-15		-85	mA	
I _{CC}	Power Supply Current	V _{CC} = MAX. (Note 4)			38	60	mA	

- Notes: 1. Typical limits are at V_{CC} = 5.0V, 25°C ambient and maximum loading.
 2. For conditions shown as MIN. or MAX., use the appropriate value specified under Operating Ranges for the applicable device type.
 3. Not more than one output should be shorted at a time.
 4. I_{CC}-measured with clock input HIGH and output controls HIGH.

SWITCHING CHARACTERISTICS ($T_A = +25^\circ\text{C}$, $V_{CC} = 5.0\text{V}$)

Parameters	Description	Test Conditions	Min	Typ	Max	Units	
t_{PLH}	Clock to Q_0 or Q_7	$C_L = 15\text{pF}$ $R_L = 2.0\text{k}\Omega$		18	26	ns	
t_{PHL}				23	28		
t_{PLH}	Clock to DY_i			18	26	ns	
t_{PHL}				21	28		
t_s	S_1, S_0 Set-up Prior to Clock			12		ns	
t_s	DY_i or S_R, S_L Set-up Prior to Clock			12		ns	
t_{pw}	Pulse Width (Clock)			15		ns	
t_s	Clear to Clock			15		ns	
t_{ZH}	$S_1, S_0, \bar{G}_1, \bar{G}_2$ to DY_i				18	30	ns
t_{ZL}					20	30	
t_{LZ}	$S_1, S_0, \bar{G}_1, \bar{G}_2$ to DY_i	$C_L = 5.0\text{pF}$ $R_L = 2.0\text{k}\Omega$		22	33	ns	
t_{HZ}				16	23		
f_{max}	Maximum Clock Frequency (Note 1)		35	50		MHz	

Note 1. Per industry convention, f_{max} is the worst case value of the maximum device operating frequency with no constraints on t_r , t_f , pulse width or duty cycle.

SWITCHING CHARACTERISTICS over operating range unless otherwise specified*

Parameters	Description	Test Conditions	COMMERCIAL		MILITARY		Units	
			Am25LS		Am25LS			
			Min	Max	Min	Max		
t_{PLH}	Clock to Q_0 or Q_7	$C_L = 50\text{pF}$ $R_L = 2.0\text{k}\Omega$		38		44	ns	
t_{PHL}				40		47		
t_{PLH}	Clock to DY_i			38		44	ns	
t_{PHL}				40		47		
t_s	S_1, S_0 Set-up Prior to Clock			20		23	ns	
t_s	DY_i or S_R, S_L Set-up Prior to Clock			20		23	ns	
t_{pw}	Pulse Width (Clock)			24		27	ns	
t_s	Clear to Clock			24		27	ns	
t_{ZH}	$S_1, S_0, \bar{G}_1, \bar{G}_2$ to DY_i				43		50	ns
t_{ZL}					43		50	
t_{LZ}	$S_1, S_0, \bar{G}_1, \bar{G}_2$ to DY_i	$C_L = 5.0\text{pF}$ $R_L = 2.0\text{k}\Omega$		43		50	ns	
t_{HZ}				30		35		
f_{max}	Maximum Clock Frequency (Note 1)		26		23		MHz	

*AC performance over the operating temperature range is guaranteed by testing defined in Group A, Subgroup 9.

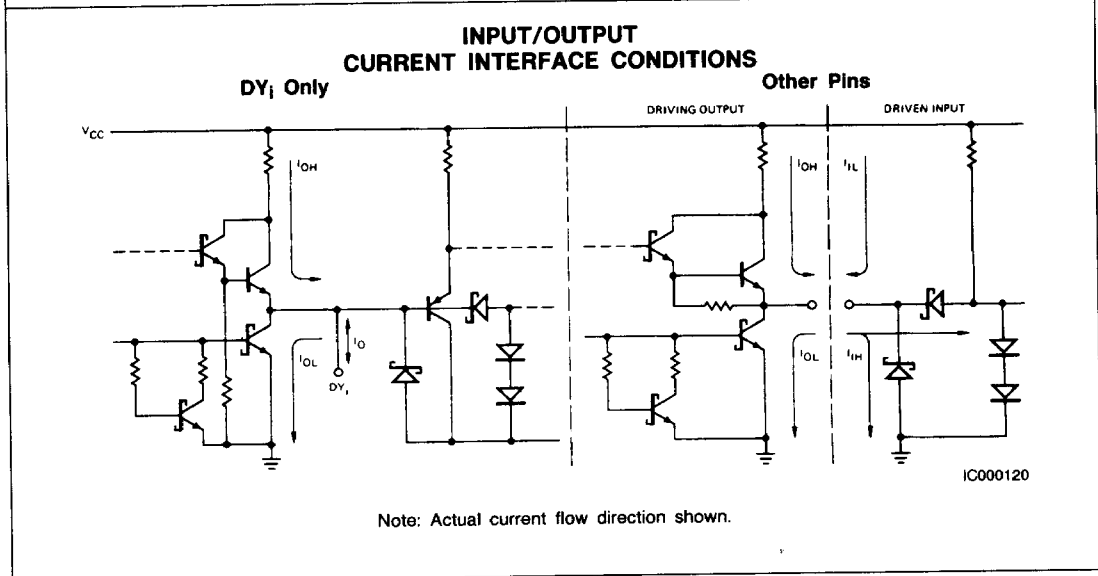

This datasheet has been downloaded from:

www.DatasheetCatalog.com

Datasheets for electronic components.



LittleDiode supplies new, hard to find or obsolete electronic components and semiconductors all over the world.

With over two million different components listed you are sure to find the part you need.

Feel free to visit us today at our online store:

LittleDiode.com

Looking forward to providing you with the best possible service.