



DUAL MICROPOWER RAIL-TO-RAIL CMOS OPERATIONAL AMPLIFIER

GENERAL DESCRIPTION

The ALD2701 is a dual monolithic CMOS micropower high slew rate operational amplifier intended for a broad range of analog applications using $\pm 1V$ to $\pm 6V$ dual power supply systems, as well as $+2V$ to $+12V$ battery operated systems. All device characteristics are specified for $+5V$ single supply or $\pm 2.5V$ dual supply systems. Supply current is $500\mu A$ maximum at $5V$ supply voltage. It is manufactured with Advanced Linear Devices' enhanced ACMOS silicon gate CMOS process.

The ALD2701 is designed to offer a trade-off of performance parameters providing a wide range of desired specifications. It offers the popular industry standard pin configuration of $\mu A747$ and ICL7621 types.

The ALD2701 has been developed specifically for the $+5V$ single supply or $\pm 1V$ to $\pm 6V$ dual supply user. Several important characteristics of the device make application easier to implement at those voltages.

First, each operational amplifier can operate with rail-to-rail input and output voltages. This means the signal input voltage and output voltage can be equal to the positive and negative supply voltages. This feature allows numerous analog serial stages and flexibility in input signal bias levels. Secondly, each device was designed to accommodate mixed applications where digital and analog circuits may operate off the same power supply or battery. Thirdly, the output stage can typically drive up to $50pF$ capacitive and $10K\Omega$ resistive loads.

These features, combined with extremely low input currents, high open loop voltage gain of $100V/mV$, useful bandwidth of $700KHz$, a slew rate of $0.7V/\mu s$, low power dissipation of $0.5mW$, low offset voltage and temperature drift, make the ALD2701 a versatile, micropower dual operational amplifier.

The ALD2701, designed and fabricated with silicon gate CMOS technology, offers $1pA$ typical input bias current. On chip offset voltage trimming allows the device to be used without nulling in most applications.

Due to low voltage and low power operation, reliability and operating characteristics, such as input bias currents and warm up time, are greatly improved.

ORDERING INFORMATION

Operating Temperature Range		
$-55^{\circ}C$ to $+125^{\circ}C$	$0^{\circ}C$ to $+70^{\circ}C$	$0^{\circ}C$ to $+70^{\circ}C$
8-Pin CERDIP Package	8-Pin Small Outline Package (SOIC)	8-Pin Plastic Dip Package
ALD 2701A DA	ALD 2701A SA	ALD 2701A PA
ALD 2701B DA	ALD 2701B SA	ALD 2701B PA
ALD 2701 DA	ALD 2701 SA	ALD 2701 PA

* Contact factory for industrial temperature range

FEATURES

- All parameters specified for $+5V$ single supply or $\pm 2.5V$ dual supply systems
- Rail to rail input and output voltage ranges
- Unity gain stable
- Extremely low input bias currents -- $1.0pA$
- High source impedance applications
- Dual power supply $\pm 1.0V$ to $\pm 6.0V$
- Single power supply $+2V$ to $+12V$
- High voltage gain
- Output short circuit protected
- Unity gain bandwidth of $0.7MHz$
- Slew rate of $0.7V/\mu s$
- Low power dissipation
- Symmetrical output drive

APPLICATIONS

- Voltage follower/buffer/amplifier
- Charge integrator
- Photodiode amplifier
- Data acquisition systems
- High performance portable instruments
- Signal conditioning circuits
- Sensor and transducer amplifiers
- Low leakage amplifiers
- Active filters
- Sample/Hold amplifier
- Picoammeter
- Current to voltage converter

PIN CONFIGURATION

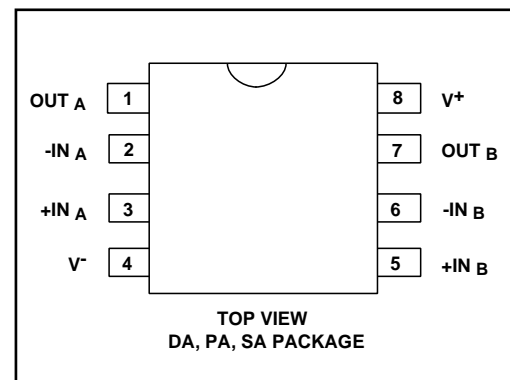

ABSOLUTE MAXIMUM RATINGS

Supply voltage, V+	13.2V
Differential input voltage range	-0.3V to V+ +0.3V
Power dissipation	600 mW
Operating temperature range	PA,SA package 0°C to +70°C DA package -55°C to +125°C
Storage temperature range	-65°C to +150°C
Lead temperature, 10 seconds	+260°C

OPERATING ELECTRICAL CHARACTERISTICS

T_A = 25°C V_S = ±2.5V unless otherwise specified

Parameter	Symbol	2701A			2701B			2701			Unit	Test Conditions
		Min	Typ	Max	Min	Typ	Max	Min	Typ	Max		
Supply Voltage	V _S	±1.0		±6.0	±1.0		±6.0	±1.0		±6.0	V	Dual Supply
	V+	2.0		12.0	2.0		12.0	2.0		12.0	V	Single Supply
Input Offset Voltage	V _{OS}			2.0 2.8			5.0 5.8			10.0 11.0	mV mV	R _S ≤ 100KΩ 0°C ≤ T _A ≤ +70°C
Input Offset Current	I _{OS}		1.0	25 240		1.0	25 240		1.0	30 450	pA pA	T _A = 25°C 0°C ≤ T _A ≤ +70°C
Input Bias Current	I _B		1.0	30 300		1.0	30 300		1.0	50 600	pA pA	T _A = 25°C 0°C ≤ T _A ≤ +70°C
Input Voltage Range	V _{IR}	-0.3 -2.8		5.3 2.8	-0.3 -2.8		5.3 2.8	-0.3 -2.8		5.3 2.8	V V	V ⁺ = +5 V _S = ±2.5V
Input Resistance	R _{IN}		10 ¹²			10 ¹²			10 ¹²		Ω	
Input Offset Voltage Drift	TCV _{OS}		5			5			7		μV/°C	R _S ≤ 100KΩ
Power Supply Rejection Ratio	PSRR	65	80		65	80		60	80		dB	R _S ≤ 100KΩ 0°C ≤ T _A ≤ +70°C
		65	80		65	80		60	80		dB	
Common Mode Rejection Ratio	CMRR	65	83		65	83		60	83		dB	R _S ≤ 100KΩ 0°C ≤ T _A ≤ +70°C
		65	83		65	83		60	83		dB	
Large Signal Voltage Gain	A _V	15	100		15	100		10	80		V/mV	R _L = 100KΩ R _L ≥ 1MΩ R _L = 100KΩ 0°C ≤ T _A ≤ +70°C
		10	300		10	300		7	300		V/mV V/mV	
Output Voltage Range	V _O low		0.001	0.01		0.001	0.01		0.001	0.01	V	R _L = 1MΩ V ⁺ = +5V 0°C ≤ T _A ≤ +70°C
	V _O high	4.99	4.999		4.99	4.999		4.99	4.999		V	
Output Voltage Range	V _O low		-2.48	-2.40		-2.48	-2.40		-2.48	-2.40	V	R _L = 100KΩ 0°C ≤ T _A ≤ +70°C
	V _O high	2.40	2.48		2.40	2.48		2.40	2.48		V	
Output Short Circuit Current	I _{SC}		1			1			1		mA	
Supply Current	I _S		240	500		240	500		240	500	μA	V _{IN} = 0V No Load
Power Dissipation	P _D			2.5			2.5			2.5	mW	Both amplifiers V _S = ±2.5V

OPERATING ELECTRICAL CHARACTERISTICS (cont'd)

$T_A = 25^\circ\text{C}$ $V_S = \pm 2.5\text{V}$ unless otherwise specified

Parameter	Symbol	2701A			2701B			2701			Unit	Test Conditions
		Min	Typ	Max	Min	Typ	Max	Min	Typ	Max		
Input Capacitance	C_{IN}		1			1			1		pF	
Bandwidth	B_W	400	700		400	700			700		KHz	
Slew Rate	S_R		0.7			0.7			0.7		V/ μs	$A_V = +1$ $R_L = 100\text{K}\Omega$
Rise time	t_r		0.2			0.2			0.2		μs	$R_L = 100\text{K}\Omega$
Overshoot Factor			20			20			20		%	$R_L = 100\text{K}\Omega$ $C_L = 50\text{pF}$
Settling Time	t_s		10.0			10.0			10.0		μs	0.1% $A_V = -1$ $C_L = 50\text{pF}$ $R_L = 100\text{K}\Omega$
Channel Separation	C_S		120			120			120		dB	$A_V = 100$

$T_A = 25^\circ\text{C}$ $V_S = \pm 5.0\text{V}$ unless otherwise specified

Parameter	Symbol	2701A			2701B			2701			Unit	Test Conditions
		Min	Typ	Max	Min	Typ	Max	Min	Typ	Max		
Power Supply Rejection Ratio	PSRR		83			83			83		dB	$R_S \leq 100\text{K}\Omega$
Common Mode Rejection Ratio	CMRR		83			83			83		dB	$R_S \leq 100\text{K}\Omega$
Large Signal Voltage Gain	A_V		250			250			250		V/mV	$R_L = 100\text{K}\Omega$
Output Voltage Range	$V_{O\text{ low}}$ $V_{O\text{ high}}$	4.90	-4.98 4.98	-4.90	4.90	-4.98 4.98	-4.90	4.90	-4.98 4.98	-4.90	V V	$R_L = 100\text{K}\Omega$
Bandwidth	B_W		1.0			1.0			1.0		MHz	
Slew Rate	S_R		1.0			1.0			1.0		V/ μs	$A_V = +1$ $C_L = 50\text{pF}$

$V_S = \pm 2.5\text{V}$ $-55^\circ\text{C} \leq T_A \leq +125^\circ\text{C}$ unless otherwise specified

Parameter	Symbol	2701A DA			2701B DA			2701 DA			Unit	Test Conditions
		Min	Typ	Max	Min	Typ	Max	Min	Typ	Max		
Input Offset Voltage	V_{OS}			3.0			6.0			15.0	mV	$R_S \leq 100\text{K}\Omega$
Input Offset Current	I_{OS}			8.0			8.0			8.0	nA	
Input Bias Current	I_B			10.0			10.0			10.0	nA	
Power Supply Rejection Ratio	PSRR	60	75		60	75		60	75		dB	$R_S \leq 100\text{K}\Omega$
Common Mode Rejection Ratio	CMRR	60	83		60	83		60	83		dB	$R_S \leq 100\text{K}\Omega$
Large Signal Voltage Gain	A_V	10	50		10	50		7	50		V/mV	$R_L \leq 100\text{K}\Omega$
Output Voltage Range	$V_{O\text{ low}}$ $V_{O\text{ high}}$	2.35	-2.47 2.45	-2.40	2.35	-2.47 2.45	-2.40	2.35	-2.47 2.45	-2.40	V V	$R_L \leq 100\text{K}\Omega$

Design & Operating Notes:

1. The ALD2701 CMOS operational amplifier uses a 3 gain stage architecture and an improved frequency compensation scheme to achieve large voltage gain, high output driving capability, and better frequency stability. In a conventional CMOS operational amplifier design, compensation is achieved with a pole splitting capacitor together with a nulling resistor. This method is, however, very bias dependent and thus cannot accommodate the large range of supply voltage operation as is required from a stand alone CMOS operational amplifier. The ALD2701 is internally compensated for unity gain stability using a novel scheme that does not use a nulling resistor. This scheme produces a clean single pole roll off in the gain characteristics while providing for more than 70 degrees of phase margin at the unity gain frequency.
2. The ALD2701 has complementary p-channel and n-channel input differential stages connected in parallel to accomplish rail to rail input common mode voltage range. This means that with the ranges of common mode input voltage close to the power supplies, one of the two differential stages is switched off internally. To maintain compatibility with other operational amplifiers, this switching point has been selected to be about 1.5V below the positive supply voltage. Since offset voltage trimming on the ALD2701 is made when the input voltage is symmetrical to the supply voltages, this internal switching does not affect a large variety of applications such as an inverting amplifier or non-inverting amplifier with a gain larger than 2.5 (5V operation), where the common mode voltage does not make excursions above this switching point. The user should however, be aware that this switching does take place if the operational amplifier is connected as a unity gain buffer, and should make provision in his design to allow for input offset voltage variations.
3. The input bias and offset currents are essentially input protection diode reverse bias leakage currents, and are typically less than 1pA

at room temperature. This low input bias current assures that the analog signal from the source will not be distorted by input bias currents. Normally, this extremely high input impedance of greater than $10^{12}\Omega$ would not be a problem as the source impedance would limit the node impedance. However, for applications where source impedance is very high, it may be necessary to limit noise and hum pickup through proper shielding.

4. The output stage consists of class AB complementary output drivers, capable of driving a low resistance load. The output voltage swing is limited by the drain to source on-resistance of the output transistors as determined by the bias circuitry, and the value of the load resistor. When connected in the voltage follower configuration, the oscillation resistant feature, combined with the rail to rail input and output feature, makes an effective analog signal buffer for medium to high source impedance sensors, transducers, and other circuit networks.
5. The ALD2701 operational amplifier has been designed to provide full static discharge protection. Internally, the design has been carefully implemented to minimize latch up. However, care must be exercised when handling the device to avoid strong static fields that may degrade a diode junction, causing increased input leakage currents. In using the operational amplifier, the user is advised to power up the circuit before, or simultaneously with, any input voltages applied and to limit input voltages not to exceed 0.3V of the power supply voltage levels.
6. The ALD2701, with its micropower operation, offers numerous benefits in reduced power supply requirements, less noise coupling and current spikes, less thermally induced drift, better overall reliability due to lower self heating, and lower input bias current. It requires practically no warm up time as the chip junction heats up to only 0.2°C above ambient temperature under most operating conditions.

TYPICAL PERFORMANCE CHARACTERISTICS

SUPPLY CURRENT AS A FUNCTION OF SUPPLY VOLTAGE

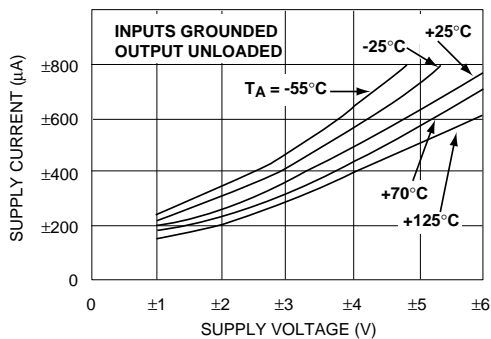

COMMON MODE INPUT VOLTAGE RANGE AS A FUNCTION OF SUPPLY VOLTAGE

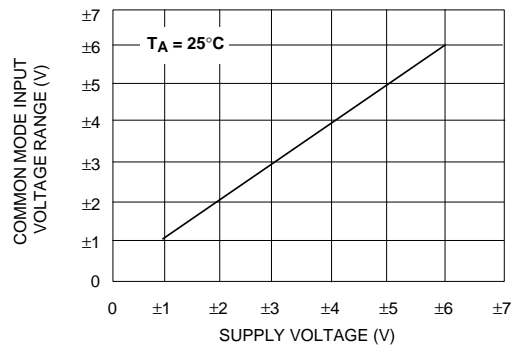

OPEN LOOP VOLTAGE GAIN AS A FUNCTION OF LOAD RESISTANCE

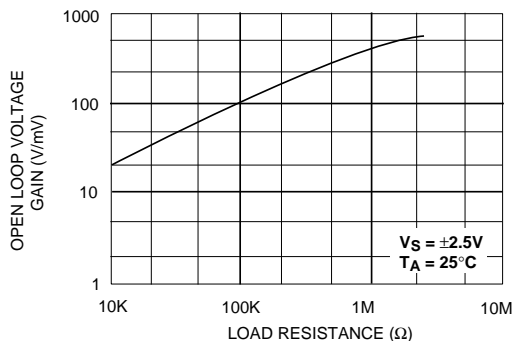

INPUT BIAS CURRENT AS A FUNCTION OF AMBIENT TEMPERATURE

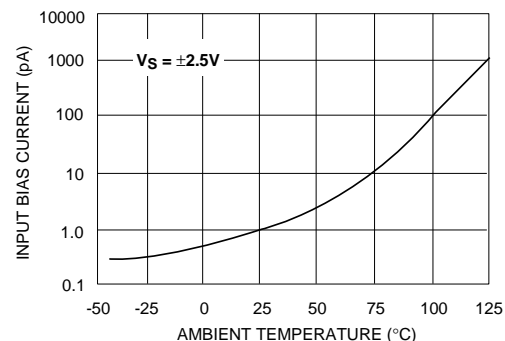

TYPICAL PERFORMANCE CHARACTERISTICS

OPEN LOOP VOLTAGE GAIN AS A FUNCTION OF SUPPLY VOLTAGE AND TEMPERATURE

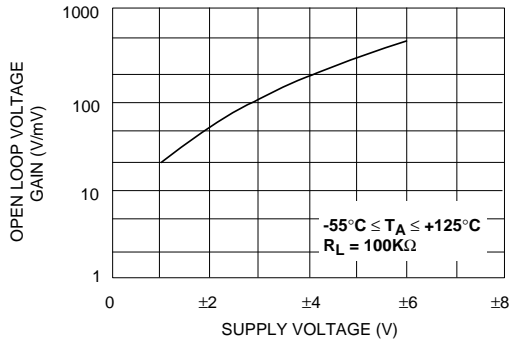

OUTPUT VOLTAGE SWING AS A FUNCTION OF SUPPLY VOLTAGE

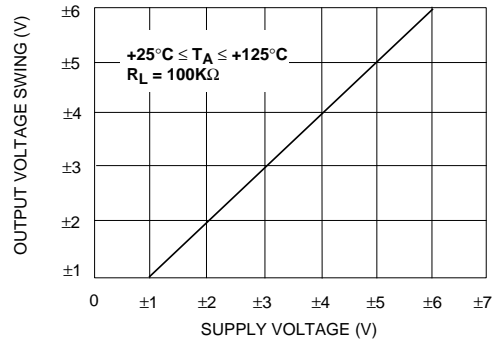

INPUT OFFSET VOLTAGE AS A FUNCTION OF AMBIENT TEMPERATURE REPRESENTATIVE UNITS

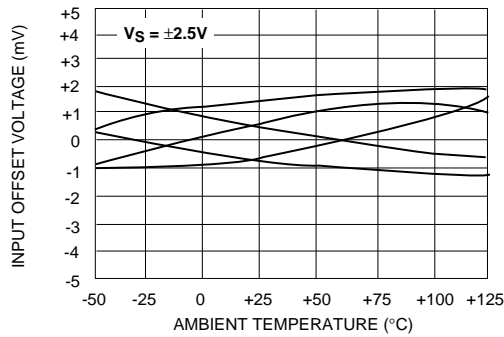

OPEN LOOP VOLTAGE GAIN AS A FUNCTION OF FREQUENCY

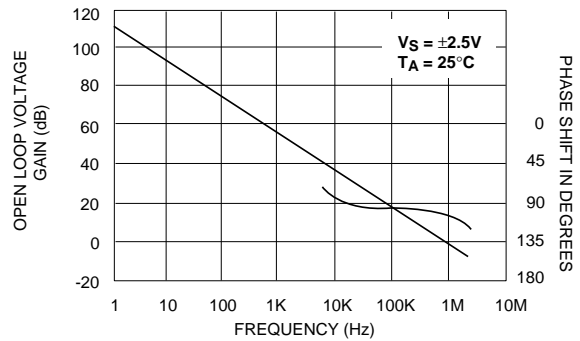

INPUT OFFSET VOLTAGE AS A FUNCTION OF COMMON MODE INPUT VOLTAGE

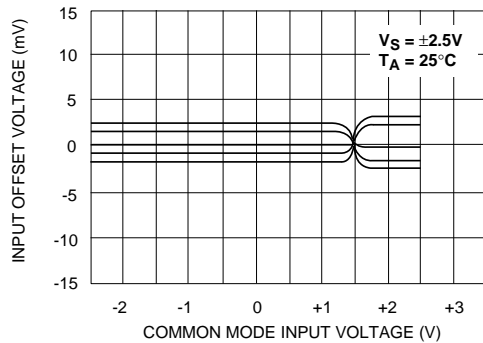

LARGE - SIGNAL TRANSIENT RESPONSE

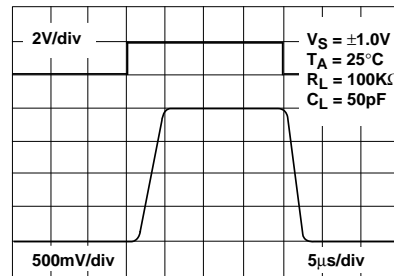

LARGE - SIGNAL TRANSIENT RESPONSE

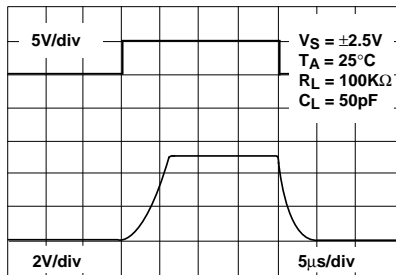

SMALL - SIGNAL TRANSIENT RESPONSE

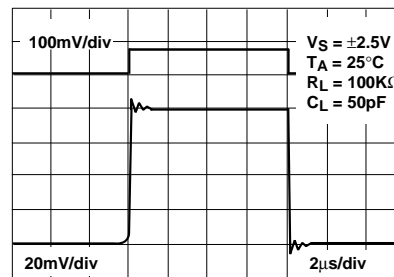

TYPICAL APPLICATIONS

RAIL-TO-RAIL VOLTAGE FOLLOWER/BUFFER

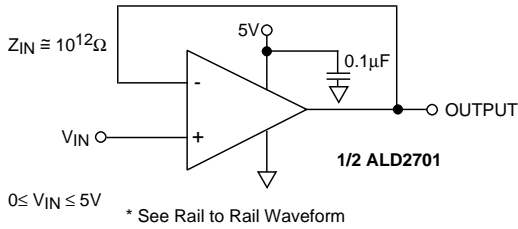

RAIL-TO-RAIL WAVEFORM

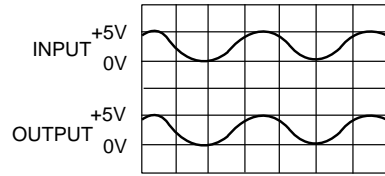

Performance waveforms.
Upper trace is the output of a Wien Bridge Oscillator. Lower trace is the output of Rail-to-Rail voltage follower.

HIGH INPUT IMPEDANCE RAIL-TO-RAIL PRECISION DC SUMMING AMPLIFIER

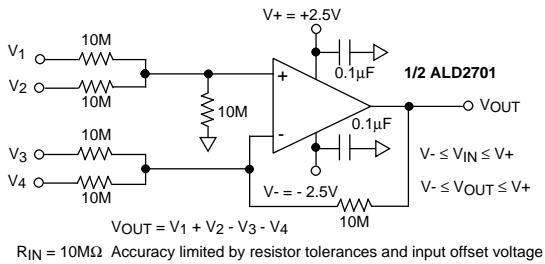

RAIL-TO-RAIL WINDOW COMPARATOR

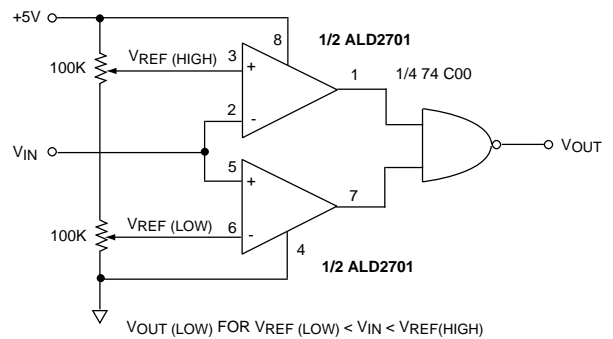

WIEN BRIDGE OSCILLATOR (RAIL-TO-RAIL) SINE WAVE GENERATOR

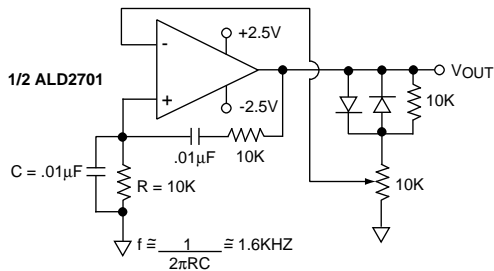

*See Rail to Rail Waveform

PHOTO DETECTOR CURRENT TO VOLTAGE CONVERTER

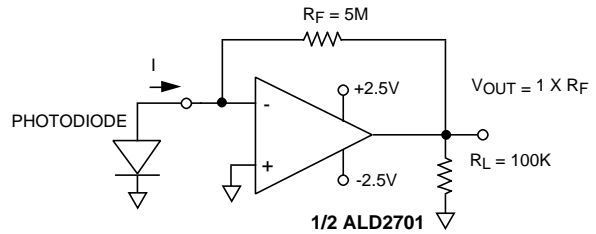

LOW VOLTAGE INSTRUMENTATION AMPLIFIER

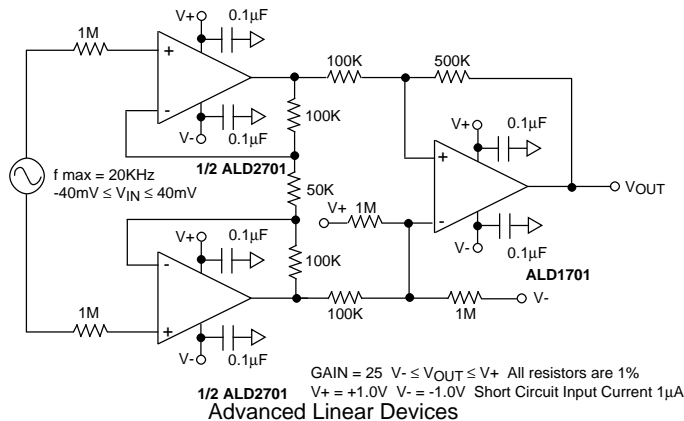



LittleDiode supplies new, hard to find or obsolete electronic components and semiconductors all over the world.

With over two million different components listed you are sure to find the part you need.

Feel free to visit us today at our online store:

LittleDiode.com

Looking forward to providing you with the best possible service.