

K4N31

These Photocouplers consist of a Gallium Arsenide Infrared Emitting Diode and a Silicon NPN Photo Darlington transistor in a 6-pin package.

FEATURES

- Small Package Size
- Collector-Emitter Voltage : Min.30V
- Current Transfer Ratio : Type 1000% (at $I_F=10\text{mA}$, $V_{CE}=10\text{V}$)
- Electrical Isolation Voltage : AC2500V_{rms}
- UL Recognized File No. E107486

APPLICATIONS

- Interface between two circuits of different potential
- Telephone Line Receiver, CMOS Logic Interface
- Power Supply Regulators

DIMENSION

(Unit : mm)

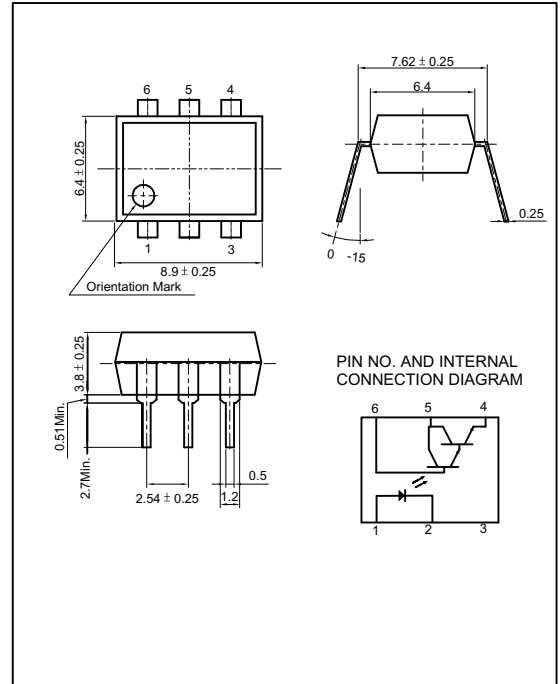

MAXIMUM RATINGS

($T_a=25$)

Parameter		Symbol	Rating	Unit
Input	Forward Current	I_F	80	mA
	Reverse Voltage	V_R	5	V
	Peak Forward Current ^{*1}	I_{FP}	3	A
	Power Dissipation	P_D	150	mW
Output	Collector-Emitter Breakdown Voltage	BV_{CEO}	30	V
	Emitter-Collector Breakdown Voltage	BV_{ECO}	5	V
	Collector-Base Breakdown Voltage	BV_{ECO}	30	V
	Collector Current	I_C	100	mA
	Collector Power Dissipation	P_C	150	mW
Input to Output Isolation Voltage ^{*2}		V_{iso}	AC2500	V _{rms}
Storage Temperature		T_{stg}	-55~+125	
Operating Temperature		T_{opr}	-30~+100	
Lead Soldering Temperature ^{*3}		T_{sol}	260	
Total Power Dissipation		P_{tot}	250	mW

*1. Input current with 300 μ s pulse width, 2% duty cycle

*2. Measured at RH=40~60% for 1min

*3. 1/16 inch form case for 10sec

K4N31

ELECTRO-OPTICAL CHARACTERISTICS

(Ta=25 , unless otherwise noted)

Parameter		Symbol	Condition	Min.	Typ.	Max.	Unit.
Input	Forward Voltage	V _F	I _F =10mA	-	1.15	1.30	V
	Reverse Current	I _R	V _R =5V	-	-	10	μA
	Capacitance	C _T	V=0, f=1MHz	-	30	-	pF
Output	Collector-Emitter Breakdown Voltage	BV _{CEO}	I _C =1mA	30	-	-	V
	Emitter-Collector Breakdown Voltage	BV _{ECO}	I _E =0.1mA	5	-	-	V
	Collector-Base Breakdown Voltage	BV _{CBO}	I _C =0.1mA	30	-	-	V
	Collector Dark Current	I _{CEO}	I _F =0, V _{CE} =10V	-	-	100	nA
	Capacitance	C _{CE}	V _{CE} =0, f=1MHz	-	10	-	pF
Coupled	Current Transfer Ratio ^{*4}	CTR	I _F =10mA, V _{CE} =10V	50	-	-	%
	Collector-Emitter Saturation Voltage	V _{CE(SAT)}	I _F =50mA, I _C =2mA	-	-	1.2	V
	Input-Output Capacitance	C _{IO}	V=0, f=1MHz	-	1	-	pF
	Input-Output Isolation Resistance	R _{IO}	RH=40~60%, V=500V	-	10 ¹¹	-	
	Turn-on Time	t _{on}	V _{CC} =10V, R _L =100	-	-	-	μs
	Turn-off Time	t _{off}	I _C =50mA, I _F =200mA	-	-	-	μs

*4. CTR=(I_C/I_F) X 100 (%)

K4N31

Forward Current vs. Ambient Temperature

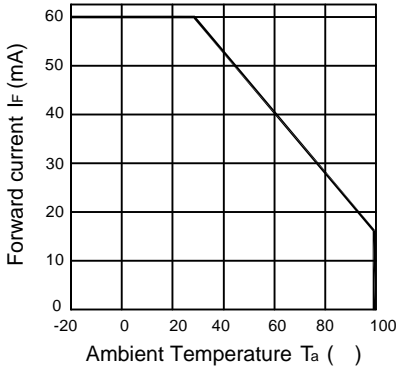

Collector Power Dissipation vs. Ambient Temperature

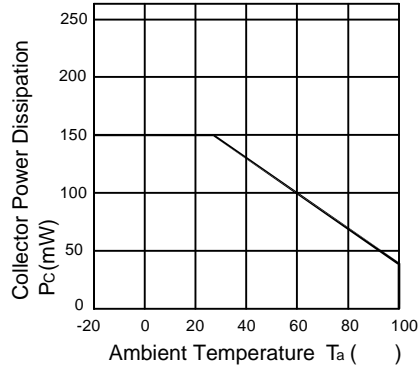

Forward Current vs. Forward Voltage

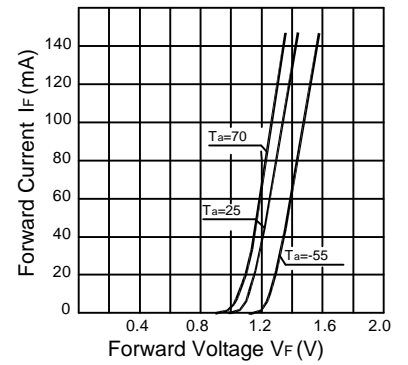

Collector Current vs. Collector-Emitter Voltage

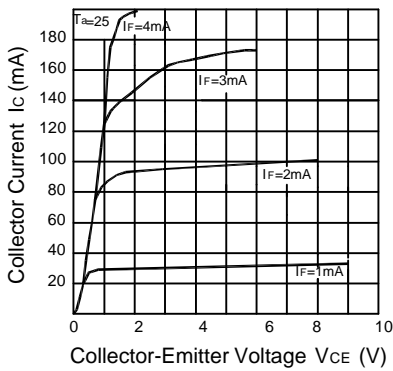

Dark Current vs. Ambient Temperature

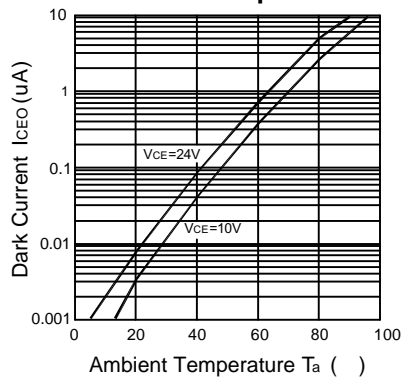

Collector Current vs. Forward Current

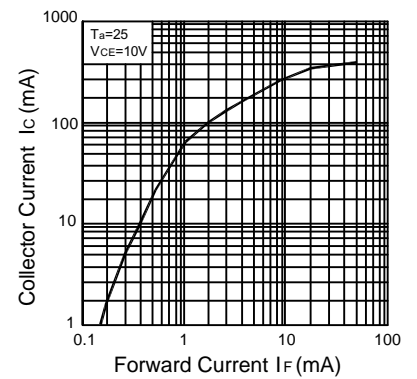

Switching Time Test Circuit

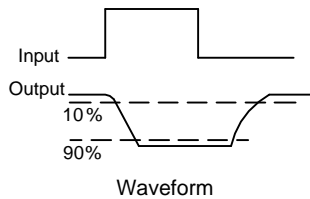
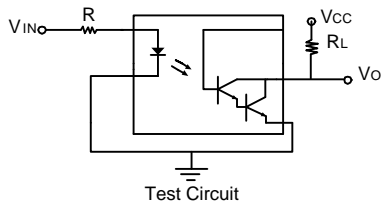

This datasheet has been downloaded from:

www.DatasheetCatalog.com

Datasheets for electronic components.



LittleDiode supplies new, hard to find or obsolete electronic components and semiconductors all over the world.

With over two million different components listed you are sure to find the part you need.

Feel free to visit us today at our online store:

LittleDiode.com

Looking forward to providing you with the best possible service.