

Schmitt-Trigger Positive-NAND Gates and Inverters with Totem-Pole Outputs

LS13 LS14

FEATURES

- Operation from Very Slow Transitions
- Temperature-Compensated Threshold Levels
- Temperature-Compensated Hysteresis, Typically 0.8V
- High Noise Immunity

DESCRIPTION

Each circuit functions as a NAND gate or inverter, but because of the Schmitt action, it has different input threshold levels for positive- and negative-going signals. The hysteresis or backlash, which is the difference between the two threshold levels, is typically 800 millivolts.

These circuits are temperature compensated and can be triggered from the slowest of input ramps and still give clean, jitter-free output signals.

PIN-OUT AND LOGIC DIAGRAMS

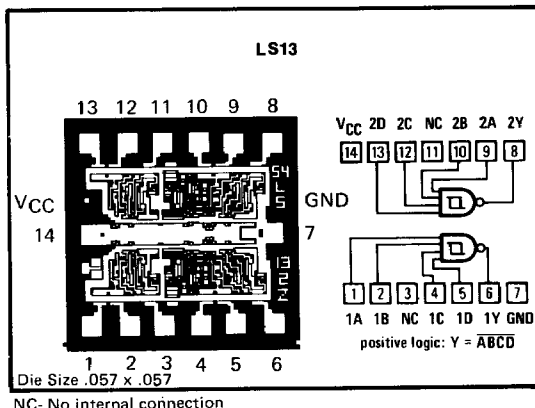

SCHEMATIC (EACH GATE)

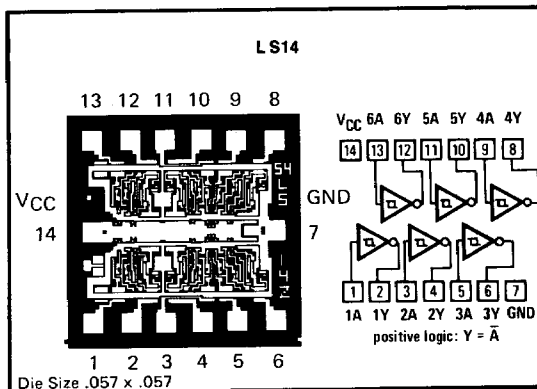
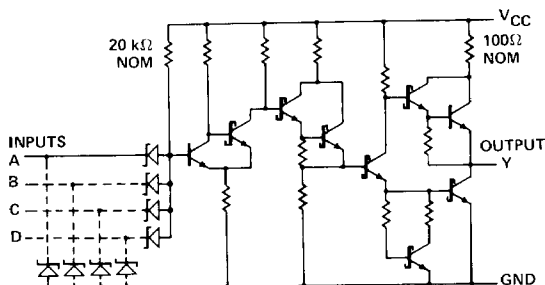

Recommended Operating Conditions

	9LS/54LS			9LS/74LS			Unit
	Min	Nom	Max	Min	Nom	Max	
Supply voltage, V_{CC}	4.5	5	5.5	4.75	5	5.25	V
High-level output current, I_{OH}			-400			-400	μA
Low-level output current, I_{OL}			4			8	mA
Operating free-air temperature, T_A	-55		125	0		70	$^{\circ}C$

Schmitt-Trigger Positive-NAND Gates and Inverters with Totem-Pole Outputs

LS13 LS14

Electrical Characteristics Over Recommended Free-Air Temperature Range (Unless Otherwise Noted)

Parameter	Test Conditions*	9LS/54LS			9LS/74LS			Unit	
		Min	Typ**	Max	Min	Typ**	Max		
V_{T+}	$V_{CC}=5V$	1.4	1.6	1.9	1.4	1.6	1.9	V	
V_{T-}	$V_{CC}=5V$.5	.8	1.0	.5	.8	1.0	V	
$V_{T+} - V_{T-}$	$V_{CC}=5V$	0.4	0.8		0.4	0.8		V	
V_I	$V_{CC}=\text{MIN}, I_I = -18\text{mA}$			-1.5			-1.5	V	
V_{OH}	$V_{CC}=\text{MIN}, I_{OH} = -400\mu\text{A}, V_I = 0.6V$	2.5	3.4		2.7	3.4		V	
V_{OL}	$V_{CC}=\text{MIN}, V_I = 2V$	$I_{OL} = 4\text{mA}$		0.25	0.4	$I_{OL} = 8\text{mA}$		V	
		$I_{OL} = 8\text{mA}$				0.25	0.4		
I_{T+}	$V_{CC}=5V, V_I = V_{T+}$					-0.14		mA	
I_{T-}	$V_{CC}=5V, V_I = V_{T-}$					-0.18		mA	
I_I	$V_{CC}=\text{MAX}, V_I = 7V$			0.1			0.1	mA	
I_{IH}	$V_{CC}=\text{MAX}, V_I = 2.7V$			20			20	μA	
I_{IL}	$V_{CC}=\text{MAX}, V_I = 0.4V$			-0.4			-0.4	mA	
I_{OS}	$V_{CC}=\text{MAX}$	-15		-100	-15		-100	mA	
I_{CCH}	$V_{CC}=\text{MAX}, V_I = 0V$	LS13	2.9	6	2.9	6			mA
		LS14	8.6	16	8.6	16			
I_{CCL}	$V_{CC}=\text{MAX}, V_I = 4.5V$	LS13	4.1	7	4.1	7			mA
		LS14	12	21	12	21			

*For conditions shown as MIN or MAX, use the appropriate value specified under recommended operating conditions for the applicable device type.

**All typical values are at $V_{CC} = 5V, T_A = 25^\circ\text{C}$.

†Not more than one output should be shorted at a time.

Switching Characteristics, $V_{CC} = 5V$ Over Recommended Free-Air Temperature Range

Parameter		-55°C			$+25^\circ\text{C}$			$+125^\circ\text{C}$			Unit
		Min	Typ	Max	Min	Typ	Max	Min	Typ	Max	
Test Conditions: $C_L = 15\text{pF}, R_L = 2\text{k}\Omega$ (See Fig. A, page 2-174)											
t_{PLH}	LS13	16	28		15	22		16	30	ns	
	LS14	16	28		15	22		16	30	ns	
t_{PHL}	LS13	22	38		18	27		20	38	ns	
	LS14	17	32		15	22		16	30	ns	
Test Conditions: $C_L = 50\text{pF}, R_L = 2\text{k}\Omega$ (See Fig. A, page 2-174)											
t_{PLH}	LS13	20	38		20	27		20	38	ns	
	LS14	20	38		20	27		21	38	ns	
t_{PHL}	LS13	25	42		25	33		25	42	ns	
	LS14	21	38		20	27		21	38	ns	

Note: AC specification shown under -55°C and $+125^\circ\text{C}$ are for 9LS devices only. All 50pF specifications are for 9LS only.

PARAMETER MEASUREMENT INFORMATION

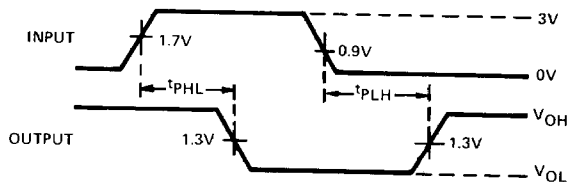

VOLTAGE WAVEFORMS

- NOTES:
- The input waveform is supplied by a generator with the following characteristics:
 $Z_{out} = 50\Omega$ and $PRR \leq 1\text{ MHz}, t_r \leq 15\text{ ns}, t_f \leq 6\text{ ns}$.
 - C_L includes probe and jig capacitance.
 - All diodes are 1N916 or 1N3064.

TYPICAL CHARACTERISTICS†

POSITIVE-GOING THRESHOLD VOLTAGE VS FREE-AIR TEMPERATURE.

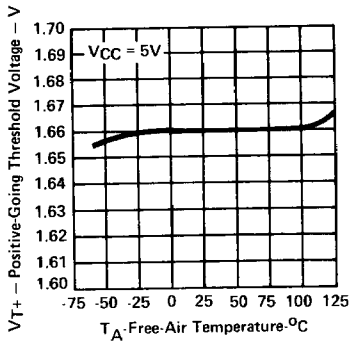

NEGATIVE-GOING THRESHOLD VOLTAGE VS FREE-AIR TEMPERATURE.

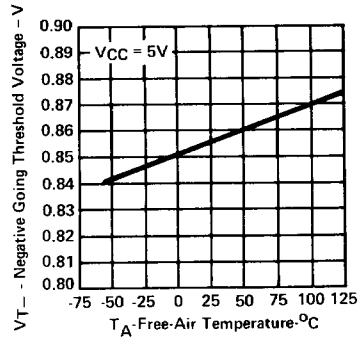

HYSTERESIS VS FREE-AIR TEMPERATURE.

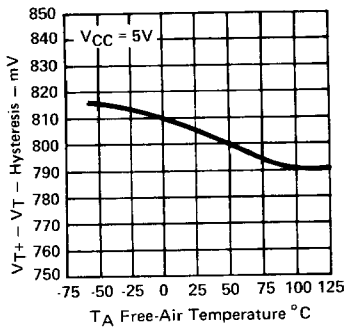

DISTRIBUTION OF UNITS FOR HYSTERESIS.

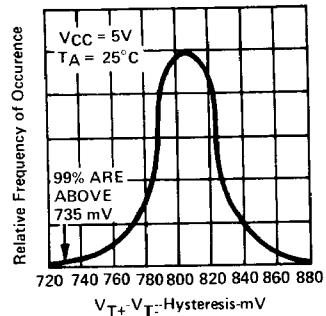

THRESHOLD VOLTAGES AND HYSTERESIS VS SUPPLY VOLTAGE.

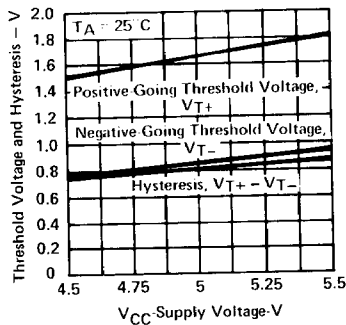

OUTPUT VOLTAGE VS INPUT VOLTAGE.

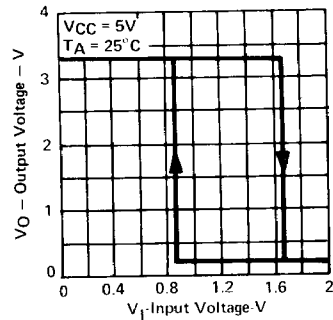

† Data for temperatures below 0°C and above 70°C and supply voltages below 4.75V and above 5.25 are applicable for 9LS/54LS13, and 9LS/54LS14.

Schmitt-Trigger Positive-NAND Gates and Inverters with Totem-Pole Outputs

LS13 LS14

TYPICAL APPLICATION DATA

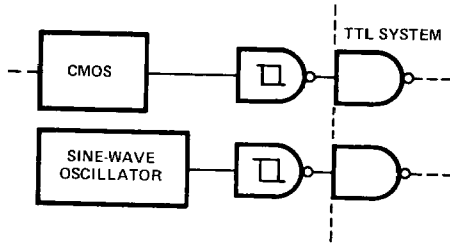

TTL SYSTEM INTERFACE FOR SLOW INPUT WAVEFORMS

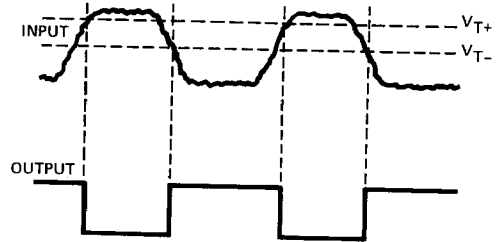

PULSE SHAPER

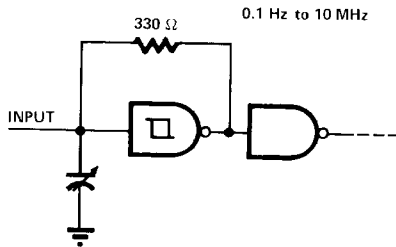

MULTIVIBRATOR

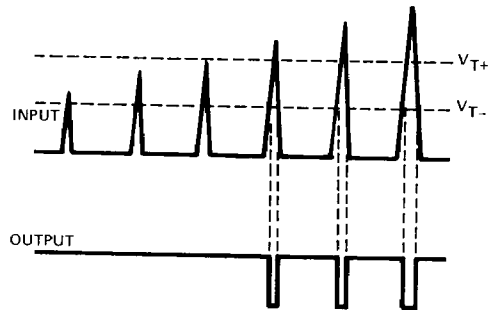

THRESHOLD DETECTOR

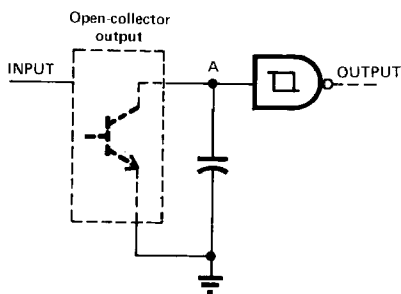

PULSE STRETCHER

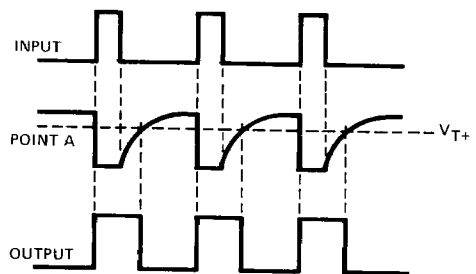

This datasheet has been downloaded from:

www.DatasheetCatalog.com

Datasheets for electronic components.



LittleDiode supplies new, hard to find or obsolete electronic components and semiconductors all over the world.

With over two million different components listed you are sure to find the part you need.

Feel free to visit us today at our online store:

LittleDiode.com

Looking forward to providing you with the best possible service.