

LM330 3-Terminal Positive Regulator

General Description

The LM330 5V 3-terminal positive voltage regulator features an ability to source 150 mA of output current with an input-output differential of 0.6V or less. Familiar regulator features such as current limit and thermal overload protection are also provided.

The low dropout voltage makes the LM330 useful for certain battery applications since this feature allows a longer battery discharge before the output falls out of regulation. For example, a battery supplying the regulator input voltage may discharge to 5.6V and still properly regulate the system and load voltage. Supporting this feature, the LM330 protects both itself and regulated systems from negative voltage inputs resulting from reverse installations of batteries.

Other protection features include line transient protection up to 26V, when the output actually shuts down to avoid damaging internal and external circuits. Also, the LM330 regulator cannot be harmed by a temporary mirror-image insertion.

Features

- Input-output differential less than 0.6V
- Output current of 150 mA
- Reverse battery protection
- Line transient protection
- Internal short circuit current limit
- Internal thermal overload protection
- Mirror-image insertion protection
- P+ Product Enhancement tested

Schematic and Connection Diagrams

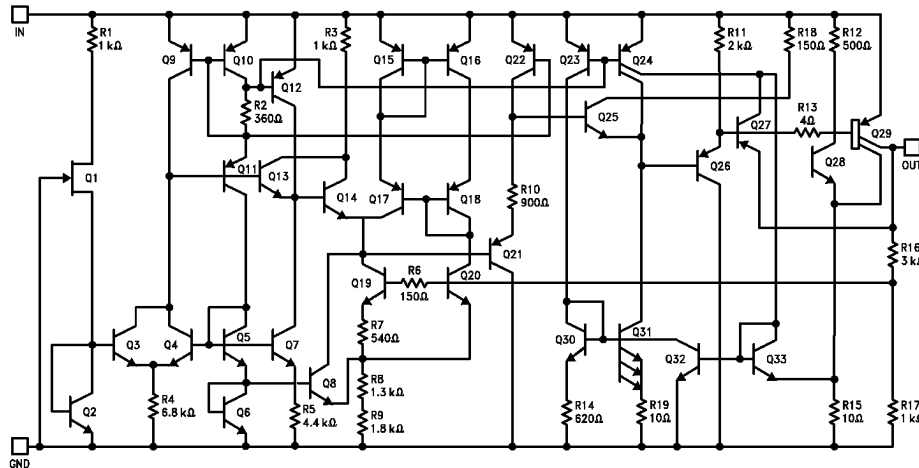

DS000306-1

(TO-220)
Plastic Package

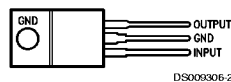

DS000306-2

Front View
Order Number LM330T-5.0
See NS Package Number T03B

Absolute Maximum Ratings (Note 1)

If Military/Aerospace specified devices are required, please contact the National Semiconductor Sales Office/Distributors for availability and specifications.

| | |
|-------------------------------------|-----|
| Input Voltage | |
| Operating Range | 26V |
| Line Transient Protection (1000 ms) | 40V |

| | |
|------------------------------|--------------------|
| Internal Power Dissipation | Internally Limited |
| Operating Temperature Range | 0°C to +70°C |
| Maximum Junction Temperature | +125°C |
| Storage Temperature Range | -65°C to +150°C |
| Lead Temperature | |
| (Soldering, 10 sec.) | +300°C |

Electrical Characteristics (Note 2)

| Symbol | Parameter | Conditions | Min | Typ | Max | Units |
|----------------------|--|---|------|------|------|-------------|
| V _o | Output Voltage | T _J = 25°C | 4.8 | 5 | 5.2 | V |
| | Output Voltage | 5 < I _o < 150 mA | 4.75 | | 5.25 | |
| | Over Temp | 6 < V _{IN} < 26V; 0°C ≤ T _J ≤ 100°C | | | | |
| ΔV _o | Line Regulation | 9 < V _{IN} < 16V, I _o = 5 mA | | 7 | 25 | mV |
| | | 6 < V _{IN} < 26V, I _o = 5 mA | | 30 | 60 | |
| | Load Regulation | 5 < I _o < 150 mA | | 14 | 50 | |
| | Long Term Stability | | | 20 | | mV/1000 hrs |
| I _o | Quiescent Current | I _o = 10 mA | | 3.5 | 7 | mA |
| | | I _o = 50 mA | | 5 | 11 | |
| | | I _o = 150 mA | | 18 | 40 | |
| Line Transient | V _{IN} = 40V, R _L = 100Ω, 1s | | | 14 | | |
| | Reverse Polarity | V _{IN} = -6V, R _L = 100Ω | | -80 | | |
| ΔI _o | Quiescent Current Change | 6 < V _{IN} < 26V | | 10 | | % |
| V _{IN} | Overvoltage Shutdown Voltage | | 26 | 38 | | V |
| | Max Line Transient | | | 60 | | |
| | | 1s, V _o ≤ 5.5V | | | 50 | |
| | Reverse Polarity | | | -30 | | |
| | Input Voltage | DC V _o > -0.3V, R _L = 100Ω | | -12 | | |
| Output Noise Voltage | 10 Hz–100 kHz | | | 50 | μV | |
| Output Impedance | I _o = 100 mADC + 10 mArms | | | 200 | mΩ | |
| Ripple Rejection | | | | 56 | dB | |
| Current Limit | | | 150 | 400 | 700 | mA |
| Dropout Voltage | I _o = 150 mA | | | 0.32 | 0.6 | V |
| Thermal Resistance | Junction to Case | | | 4 | | °C/W |
| | Junction to Ambient | | | 50 | | |

Note 1: "Absolute Maximum Ratings" indicate limits beyond which damage to the device may occur. Operating Ratings indicate conditions for which the device is functional, but do not guarantee specific performance limits.

Note 2: Unless otherwise specified: V_{IN} = 14V, I_o = 150 mA, T_J = 25°C, C1 = 0.1 μF, C2 = 10 μF. All characteristics except noise voltage and ripple rejection are measured using pulse techniques (t_W ≤ 10 ms, duty cycle ≤ 5%). Output voltage changes due to changes in internal temperature must be taken into account separately.

Typical Performance Characteristics

Dropout Voltage

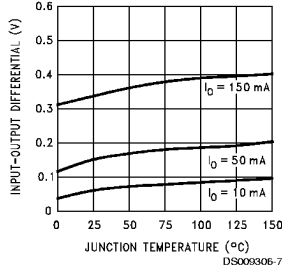

Dropout Voltage

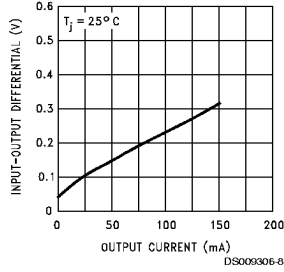

Low Voltage Behavior

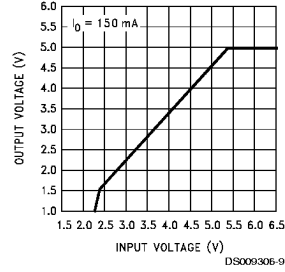

High Voltage Behavior

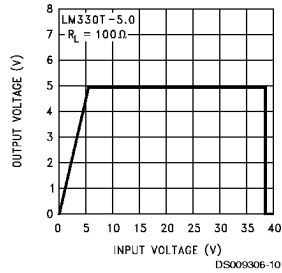

Line Transient Response

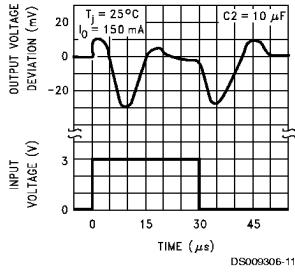

Load Transient Response

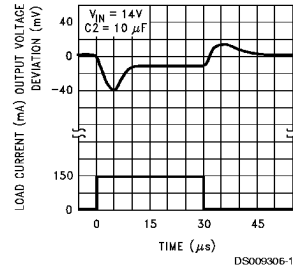

Peak Output Current

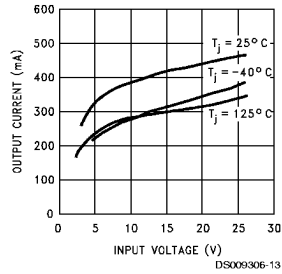

Quiescent Current

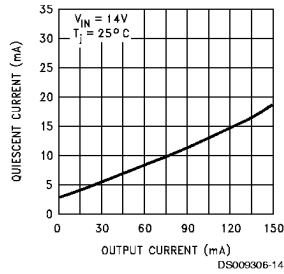

Quiescent Current

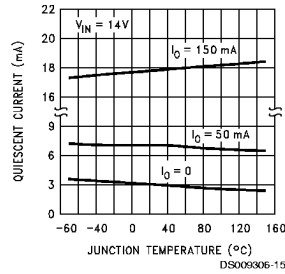

Quiescent Current

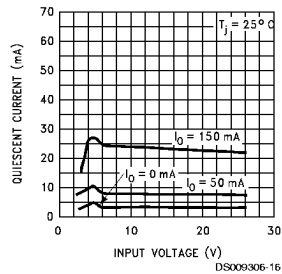

Ripple Rejection

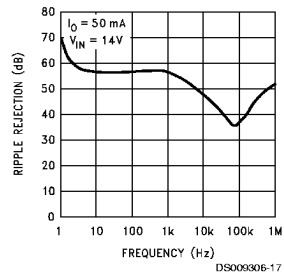

Ripple Rejection

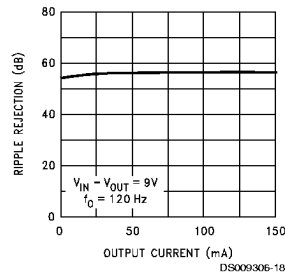

Typical Performance Characteristics (Continued)

Output Impedance

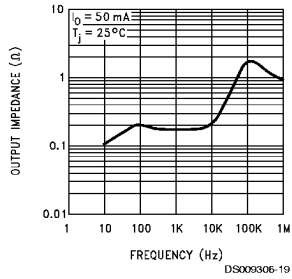

Overvoltage Supply Current

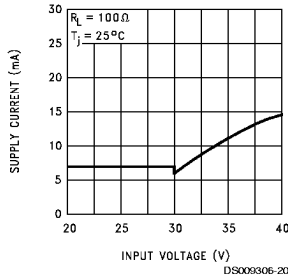

Reverse Supply Current

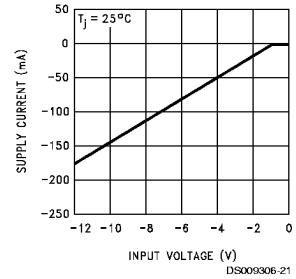

Output at Reverse Supply

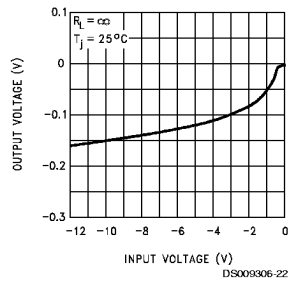

Output at Overvoltage

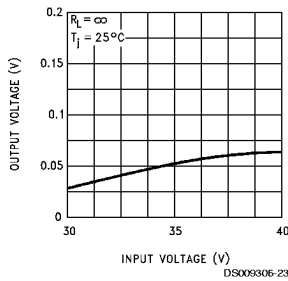

Output Voltage (Normalized to 5V at T_J = 25°C)

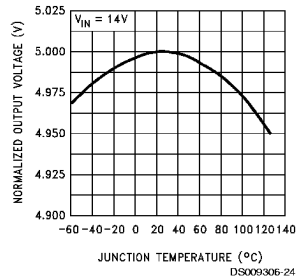

Typical Applications

The LM330 is designed specifically to operate at lower input to output voltages. The device is designed utilizing a power lateral PNP transistor which reduces dropout voltage from 2.0V to 0.3V when compared to IC regulators using NPN pass transistors. Since the LM330 can operate at a much lower input voltage, the device power dissipation is reduced, heat sinking can be simpler and device reliability improved through lower chip operating temperature. Also, a cost savings can be utilized through use of lower power/voltage components. In applications utilizing battery power, the LM330 allows the battery voltage to drop to within 0.3V of output voltage prior to the voltage regulator dropping out of regulation.

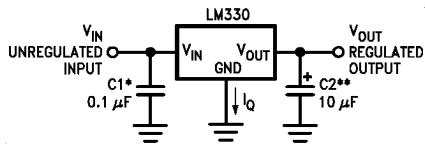

* Required if regulator is located far from power supply filter.

** C2 may be either an Aluminum or Tantalum type capacitor but must be rated to operate at -40°C to guarantee regulator stability to that temperature extreme. 10 μF is the minimum value required for stability and may be increased without bound. Locate as close as possible to the regulation.

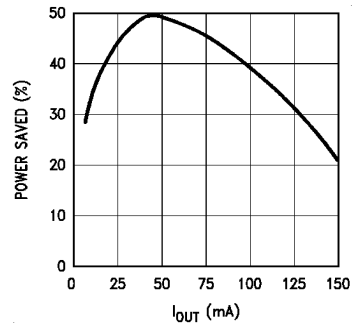

Note: Compared to IC regulator with 2.0V dropout voltage and $I_{Qmax} = 6.0$ mA.

Physical Dimensions inches (millimeters) unless otherwise noted

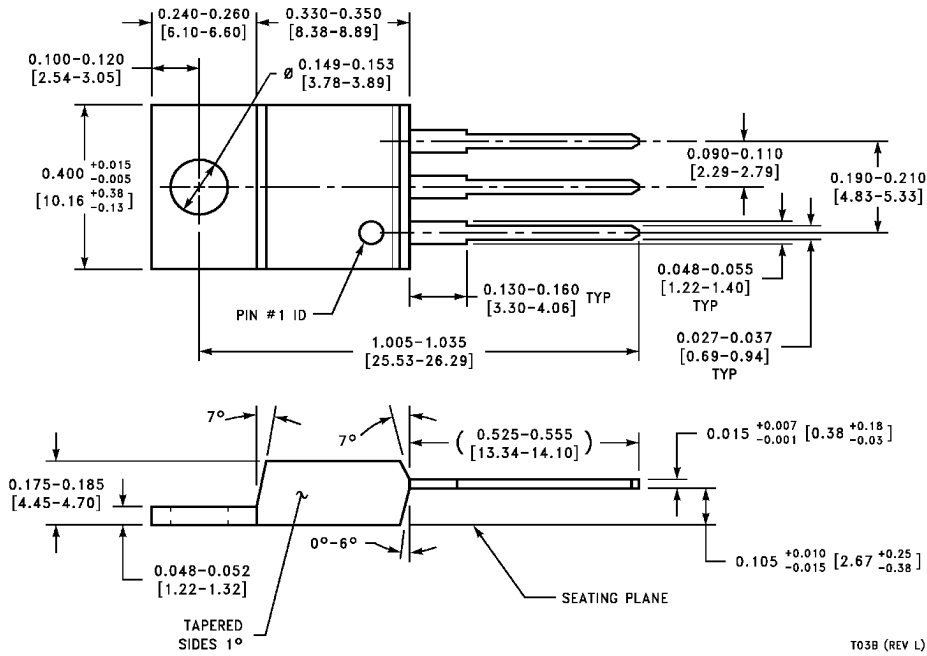

LIFE SUPPORT POLICY

NATIONAL'S PRODUCTS ARE NOT AUTHORIZED FOR USE AS CRITICAL COMPONENTS IN LIFE SUPPORT DEVICES OR SYSTEMS WITHOUT THE EXPRESS WRITTEN APPROVAL OF THE PRESIDENT AND GENERAL COUNSEL OF NATIONAL SEMICONDUCTOR CORPORATION. As used herein:

1. Life support devices or systems are devices or systems which, (a) are intended for surgical implant into the body, or (b) support or sustain life, and whose failure to perform when properly used in accordance with instructions for use provided in the labeling, can be reasonably expected to result in a significant injury to the user.
2. A critical component is any component of a life support device or system whose failure to perform can be reasonably expected to cause the failure of the life support device or system, or to affect its safety or effectiveness.

 **National Semiconductor Corporation**
Americas
Tel: 1-800-272-9959
Fax: 1-800-737-7018
Email: support@nsc.com
www.national.com

National Semiconductor Europe
Fax: +49 (0) 1 80-530 85 86
Email: europe.support@nsc.com
Deutsch Tel: +49 (0) 1 80-530 85 85
English Tel: +49 (0) 1 80-532 78 32
Français Tel: +49 (0) 1 80-532 93 58
Italiano Tel: +49 (0) 1 80-534 16 80

National Semiconductor Asia Pacific Customer Response Group
Tel: 65-2544466
Fax: 65-2504466
Email: sea.support@nsc.com

National Semiconductor Japan Ltd.
Tel: 81-3-5639-7560
Fax: 81-3-5639-7507

National does not assume any responsibility for use of any circuitry described, no circuit patent licenses are implied and National reserves the right at any time without notice to change said circuitry and specifications.