

74LS363 Latch

Octal Transparent Latch With 3-State Outputs
Product Specification

Logic Products

FEATURES

- 8-bit transparent latch
- 3-state MOS compatible output buffers
- Common Latch Enable input with hysteresis
- Common 3-state Output Enable control
- Independent latch and 3-state buffer operation

DESCRIPTION

The '363 is an octal transparent latch coupled to eight 3-state output buffers. The two sections of the device are controlled independently by Latch Enable (E) and Output Enable (\overline{OE}) control gates.

The data on the D inputs is transferred to the Latch outputs when the Latch Enable (E) input is HIGH. The latch remains transparent to the Data inputs while E is HIGH, and stores the data

TYPE	TYPICAL PROPAGATION DELAY	TYPICAL SUPPLY CURRENT (TOTAL)
74LS363	19ns	42mA

ORDERING CODE

PACKAGES	COMMERCIAL RANGE $V_{CC} = 5V \pm 5\%$; $T_A = 0^\circ C$ to $+70^\circ C$
Plastic DIP	N74LS363N

NOTE:

For information regarding devices processed to Military Specifications, see the Signetics Military Products Data Manual.

INPUT AND OUTPUT LOADING AND FAN-OUT TABLE

PINS	DESCRIPTION	74LS
All	Inputs	1LSul
All	Outputs	30LSul

NOTE:

A 74LS unit load (LSul) is $20\mu A$ I_{IH} and $-0.4mA$ I_{IL} .

present one set-up time before the HIGH-to-LOW enable transition. The enable gate has about 400mV of hysteresis

built in to help minimize problems that signal and ground noise can cause on the latching operation.

PIN CONFIGURATION

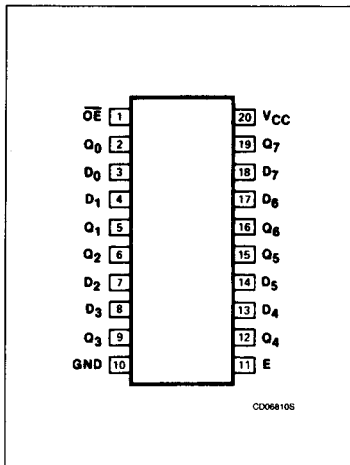

LOGIC SYMBOL

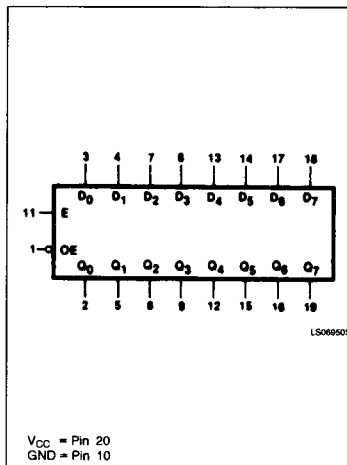

LOGIC SYMBOL (IEEE/IEC)

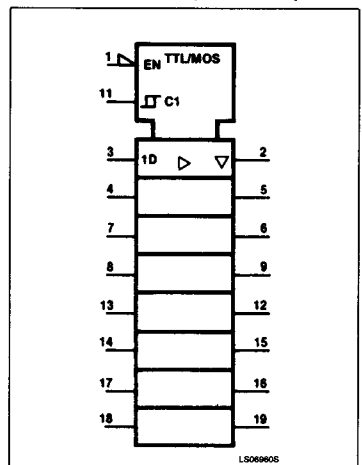

Latch

74LS363

The 3-state output buffers are designed to drive heavily loaded 3-state buses, MOS memories, or MOS microprocessors. The output HIGH level differs from the normal 3-state buffer by driving the output about 1V closer to V_{CC} , or to over 3.5V at minimum V_{CC} . This

feature makes these devices ideal for driving MOS memories or microprocessors with thresholds of 2.4V to 3.5V.

The active LOW Output Enable (\overline{OE}) controls all eight 3-state buffers independent of the

latch operation. When \overline{OE} is LOW, the latched or transparent data appears at the outputs. When \overline{OE} is HIGH, the outputs are in the HIGH impedance "off" state, which means they will neither drive nor load the bus.

LOGIC DIAGRAM

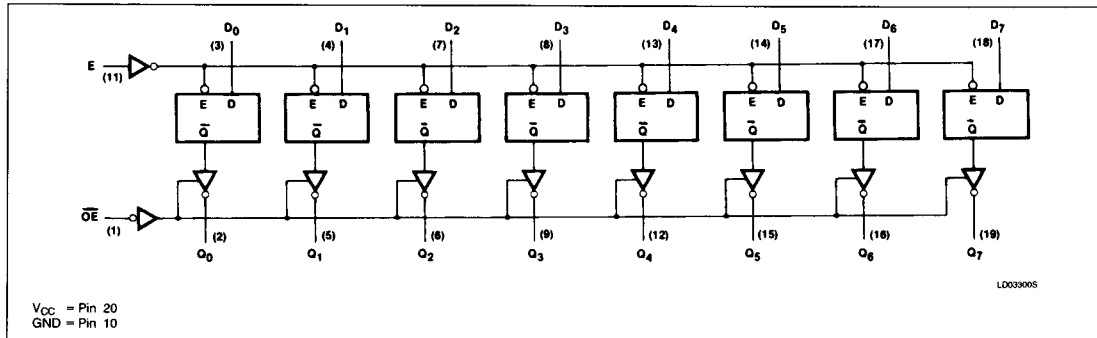

MODE SELECT — FUNCTION TABLE

OPERATING MODES	INPUTS			INTERNAL REGISTER	OUTPUTS
	\overline{OE}	E	D_n		$Q_0 - Q_7$
Enable and read register	L	H	L	L	L
	L	H	H	H	H
Latch and read register	L	L	l	L	L
	L	L	h	H	H
Latch register and disable outputs	H	L	l	L	(Z)
	H	L	h	H	(Z)

H = HIGH voltage level

h = HIGH voltage level one set-up time prior to the HIGH-to-LOW enable transition

L = LOW voltage level

l = LOW voltage level one set-up time prior to the HIGH-to-LOW enable transition

(Z) = HIGH impedance "off" state

ABSOLUTE MAXIMUM RATINGS (Over operating free-air temperature range unless otherwise noted.)

PARAMETER		74LS	UNIT
V_{CC}	Supply voltage	7.0	V
V_{IN}	Input voltage	-0.5 to +7.0	V
I_{IN}	Input current	-30 to +1	mA
V_{OUT}	Voltage applied to output in HIGH output state	-0.5 to + V_{CC}	V
T_A	Operating free-air temperature range	0 to 70	°C

Latch

74LS363

RECOMMENDED OPERATING CONDITIONS

PARAMETER		74LS			UNIT
		Min	Nom	Max	
V_{CC}	Supply voltage	4.75	5.0	5.25	V
V_{IH}	HIGH-level input voltage	2.0			V
V_{IL}	LOW-level input voltage			+0.8	V
I_{IK}	Input clamp current			-18	mA
I_{OH}	HIGH-level output voltage			-2.6	V
I_{OL}	LOW-level output current			24	mA
T_A	Operating free-air temperature	0		70	°C

DC ELECTRICAL CHARACTERISTICS (Over recommended operating free-air temperature range unless otherwise noted.)

PARAMETER	TEST CONDITIONS ¹	74LS363			UNIT	
		Min	Typ ²	Max		
V_{OH}	HIGH-level output current $V_{CC} = \text{MIN}, V_{IH} = \text{MIN}, V_{IL} = \text{MAX}, I_{OH} = \text{MAX}$	3.65			V	
V_{OL}	LOW-level output voltage $V_{CC} = \text{MIN}, V_{IH} = \text{MIN}, V_{IL} = \text{MAX}$	$I_{OL} = \text{MAX}$		0.35	0.5	V
		$I_{OL} = 12\text{mA (74LS)}$		0.25	0.4	V
V_{IK}	Input clamp voltage $V_{CC} = \text{MIN}, I_I = I_{IK}$			-1.5	V	
I_{OZH}	Off-state output current, HIGH-level voltage applied $V_{CC} = \text{MAX}, V_{IL} = \text{MAX}, V_O = 3.65\text{V}$			20	μA	
I_{OZL}	Off-state output current, LOW-level voltage applied $V_{CC} = \text{MAX}, V_{IH} = \text{MIN}, V_O = 0.4\text{V}$			-20	μA	
I_I	Input current at maximum input voltage $V_{CC} = \text{MAX}, V_I = 7.0\text{V}$			0.1	mA	
I_{IH}	HIGH-level input current $V_{CC} = \text{MAX}, V_I = 2.7\text{V}$			20	μA	
I_{IL}	LOW-level input current $V_{CC} = \text{MAX}, V_I = 0.4\text{V}$			-0.4	mA	
I_{OS}	Short-circuit output current ³ $V_{CC} = \text{MAX}$	-30		-130	mA	
I_{CC}	Supply current (total) $V_{CC} = \text{MAX}, \overline{OE} = 4.5\text{V}$		42	70	mA	

NOTES:

- For conditions shown as MIN or MAX, use the appropriate value specified under recommended operating conditions for the applicable type.
- All typical values are at $V_{CC} = 5\text{V}, T_A = 25^\circ\text{C}$.
- I_{OS} is tested with $V_{OUT} = +0.5\text{V}$ and $V_{CC} = V_{CC} \text{ MAX} + 0.5\text{V}$. Not more than one output should be shorted at a time and duration of the short circuit should not exceed one second.

AC ELECTRICAL CHARACTERISTICS $T_A = 25^\circ\text{C}, V_{CC} = 5.0\text{V}$

PARAMETER	TEST CONDITIONS	74LS		UNIT
		$C_L = 15\text{pF}, R_L = 2\text{k}\Omega$		
		Min	Max	
t_{PLH} t_{PHL}	Propagation delay Latch enable to output Waveform 1		30 36	ns
t_{PLH} t_{PHL}	Propagation delay Data to output Waveform 4		23 27	ns
t_{PZH}	Enable time to HIGH level Waveform 2		28	ns
t_{PZL}	Enable time to LOW level Waveform 3		36	ns
t_{PHZ}	Disable time from HIGH level Waveform 2, $C_L = 5\text{pF}$		20	ns
t_{PZL}	Disable time from LOW level Waveform 3, $C_L = 5\text{pF}$		25	ns

Latch

74LS363

AC SET-UP REQUIREMENTS $T_A = 25^\circ\text{C}$, $V_{CC} = 5.0\text{V}$

PARAMETER	TEST CONDITIONS	74LS		UNIT
		Min	Max	
t_W	Latch enable pulse width	Waveform 1	15	ns
t_s	Set-up time, data to latch enable	Waveform 5	0	ns
t_h	Hold time, data to latch enable	Waveform 5	10	ns

AC WAVEFORMS

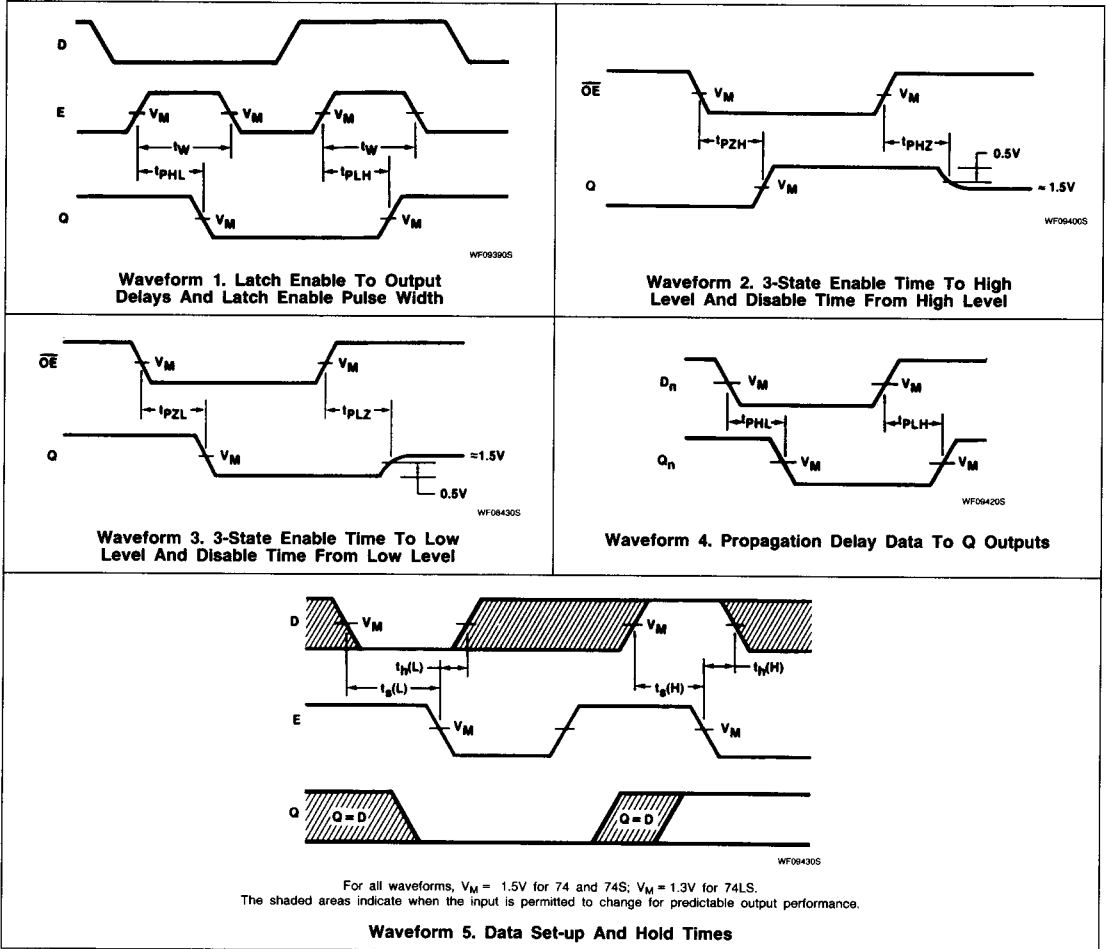

5

Latch

74LS363

TEST CIRCUITS AND WAVEFORMS

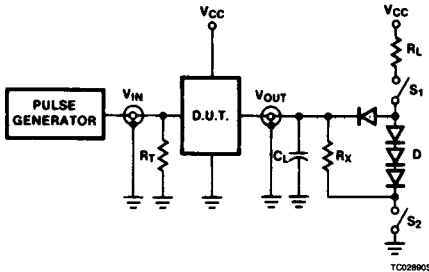

Test Circuit For 3-State Outputs

SWITCH POSITION

TEST	SWITCH 1	SWITCH 2
t _{pZH}	Open	Closed
t _{pZL}	Closed	Open
t _{pHZ}	Closed	Closed
t _{pLZ}	Closed	Closed

DEFINITIONS

R_L = Load resistor to V_{CC}; see AC CHARACTERISTICS for value.

C_L = Load capacitance includes jig and probe capacitance; see AC CHARACTERISTICS for value.

R_T = Termination resistance should be equal to Z_{OUT} of Pulse Generators.

D = Diodes are 1N916, 1N3064, or equivalent.

R_X = 1kΩ for 74, 74S, R_X = 5kΩ for 74LS.

t_{TLH}, t_{THL} Values should be less than or equal to the table entries.

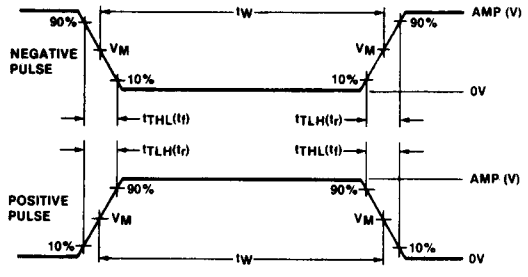

V_M = 1.3V for 74LS; V_M = 1.5V for all other TTL families.

Input Pulse Definition

FAMILY	INPUT PULSE REQUIREMENTS				
	Amplitude	Rep. Rate	Pulse Width	t _{TLH}	t _{THL}
74	3.0V	1MHz	500ns	7ns	7ns
74LS	3.0V	1MHz	500ns	15ns	6ns
74S	3.0V	1MHz	500ns	2.5ns	2.5ns

This datasheet has been downloaded from:

www.DatasheetCatalog.com

Datasheets for electronic components.



LittleDiode supplies new, hard to find or obsolete electronic components and semiconductors all over the world.

With over two million different components listed you are sure to find the part you need.

Feel free to visit us today at our online store:

LittleDiode.com

Looking forward to providing you with the best possible service.