

LM224/A, LM324/A, LM2902 QUAD OPERATIONAL AMPLIFIER

QUAD OPERATIONAL AMPLIFIERS

14 DIP

The LM224 series consists of four independent, high gain, internally frequency compensated operational amplifiers which were designed specifically to operate from a single power supply over a wide voltage range.

Operation from split power supplies is also possible so long as the difference between the two supplies is 3 volts to 32 volts.

Application areas include transducer amplifier, DC gain blocks and all the conventional OP amp circuits which now can be easily implemented in single power supply systems.

FEATURES

- Internally frequency compensated for unity gain
- Large DC voltage gain: 100dB
- Wide power supply range: LM224/A, LM324/A: 3V ~32V (or $\pm 1.5 \sim 15V$)
LM2902: 3V~26V (or $\pm 1.5V \sim 13V$)
- Input common-mode voltage range includes ground
- Large output voltage swing: 0V DC to $V_{CC} - 1.5V$ DC
- Power drain suitable for battery operation.

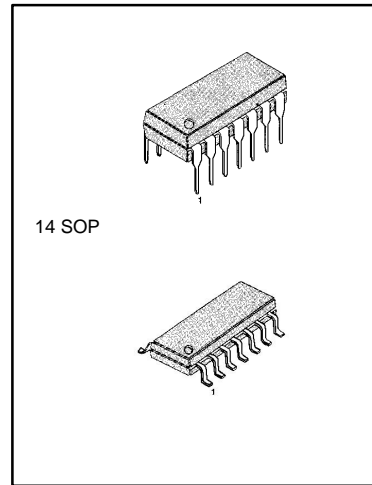

14 SOP

BLOCK DIAGRAM

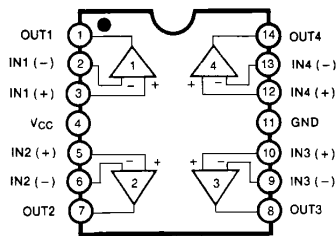

ORDERING INFORMATION

Device	Package	Operating Temperature
LM324N LM324AN	14 DIP	0 ~ +70°C
LM324M LM324AM	14 SOP	
LM224N LM224AN	14 DIP	-25 ~ +85°C
LM224M LM224AM	14 SOP	
LM2902N	14 DIP	-40 ~ +85°C
LM2902M	14 SOP	

SCHEMATIC DIAGRAM (One Section Only)

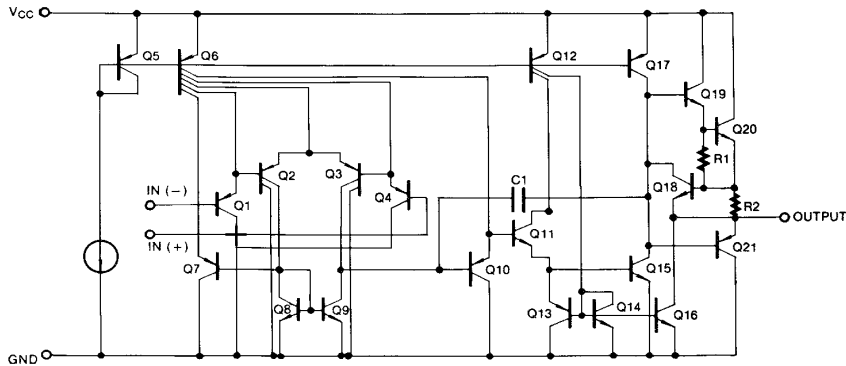

LM224/A, LM324/A, LM2902 QUAD OPERATIONAL AMPLIFIER

ABSOLUTE MAXIMUM RATINGS

Characteristic	Symbol	LM224/LM224A	LM324/LM324A	LM2902	Unit
Power Supply Voltage	V_{CC}	± 18 or 32	± 18 or 32	± 13 or 26	V
Differential Input Voltage	$V_{I(DIFF)}$	32	32	26	V
Input Voltage	V_I	-0.3 to + 32	-0.3 to +32	-0.3 to +26	V
Output Short Circuit to GND $V_{CC} \leq 15V$ $T_A = 25^\circ C$ (One Amp)		Continuous	Continuous	Continuous	
Power Dissipation	P_D	570	570	570	mW
Operating Temperature Range	T_{OPR}	-25 ~ +85	0 ~ + 70	-40 ~ + 85	$^\circ C$
Storage Temperature Range	T_{STG}	-65 ~ + 150	-65 ~ + 150	-65 ~ + 150	$^\circ C$

ELECTRICAL CHARACTERISTICS

($V_{CC} = 5.0V$, $V_{EE} = GND$, $T_A = 25^\circ C$, unless otherwise specified)

Characteristic	Symbol	Test Conditions	LM224			LM324			LM2902			Unit
			Min	Typ	Max	Min	Typ	Max	Min	Typ	Max	
Input Offset Voltage	V_{IO}	$V_{CM} = 0V$ to $V_{CC} = 1.5V$ $V_{O(P)} = 1.4V$, $R_S = 0\Omega$		1.5	5.0		1.5	7.0		1.5	7.0	mV
Input Offset Current	I_{IO}			2.0	30		3.0	50		3.0	50	nA
Input Bias Current	I_{BIAS}			40	150		40	250		40	250	nA
Input Common-Mode Voltage Range	$V_{I(R)}$	$V_{CC} = 30V$ ($V_{CC} = 26V$ for KA2902)	0		$V_{CC} - 1.5$	0	$V_{CC} - 1.5$		0		$V_{CC} - 1.5$	V
Supply Current	I_{CC}	$R_L = \infty$, $V_{CC} = 30V$ (all Amps)		1.0	3		1.0	3		1.0	3	mA
		$R_L = \infty$, $V_{CC} = 5V$ (all Amps) ($V_{CC} = 26V$ for KA2902)		0.7	1.2		0.7	1.2		0.7	1.2	mA
Large Signal Voltage Gain	G_V	$V_{CC} = 15V$, $R_L \geq 2K\Omega$ $V_{O(P)} = 1V$ to 11V	50	100		25	100			100		V/mV
Output Voltage Swing	$V_{O(H)}$	$V_{CC} = 30V$ $V_{CC} = 26V$ for 2902		26		26		22				V
		$R_L = 2K\Omega$ $R_L = 10K\Omega$	27	28		27	28		23	24		V
	$V_{O(L)}$	$V_{CC} = 5V$, $R_L \geq 10K\Omega$		5	20		5	20		5	100	mV
Common-Mode Rejection Ratio	CMRR		70	85		65	75		50	75		dB
Power Supply Rejection Ratio	PSRR		65	100		65	100		50	100		dB
Channel Separation	CS	$f = 1KHz$ to 20KHz		120			120			120		dB
Short Circuit to GND	I_{SC}			40	60		40	60		40	60	mA
Output Current	I_{SOURCE}	$V_{I(+)} = 1V$, $V_{I(-)} = 0V$ $V_{CC} = 15V$, $V_{O(P)} = 2V$	20	40		20	40		20	40		mA
		$V_{I(+)} = 0V$, $V_{I(-)} = 1V$ $V_{CC} = 15V$, $V_{O(P)} = 2V$	10	13		10	13		10	13		mA
	I_{SINK}	$V_{I(+)} = 0V$, $V_{I(-)} = 1V$ $V_{CC} = 15V$, $V_{O(R)} = 200mV$	12	45		12	45					μA
Differential Input Voltage	$V_{I(DIFF)}$				V_{CC}				V_{CC}		V_{CC}	V

LM224/A, LM324/A, LM2902 QUAD OPERATIONAL AMPLIFIER

ELECTRICAL CHARACTERISTICS

($V_{CC} = 5.0V$, $V_{EE} = GND$, unless otherwise specified)

The following specification apply over the range of $-25^{\circ}C \leq T_A \leq +85^{\circ}C$ for the LM224; and the $0^{\circ}C \leq T_A \leq +70^{\circ}C$ for the LM324 ; and the $-40^{\circ}C \leq T_A \leq +85^{\circ}C$ for the LM2902

Characteristic	Symbol	Test Conditions	LM224			LM324			LM2902			Unit
			Min	Typ	Max	Min	Typ	Max	Min	Typ	Max	
Input Offset Voltage	V_{IO}	$V_{ICM} = 0V$ to $V_{CC} = 1.5V$ $V_{O(P)} = 1.4V$, $R_S = 0\Omega$			7.0			9.0			10.0	mV
Input Offset Voltage Drift	$\Delta V_{IO}/\Delta T$			7.0			7.0			7.0		$\mu V/^{\circ}C$
Input Offset Current	I_{IO}				100			150			200	nA
Input Offset Current Drift	$\Delta I_{IO}/\Delta T$			10			10			10		$\mu A/^{\circ}C$
Input Bias Current	I_{BIAS}				300			500			500	nA
Input Common-Mode Voltage Range	$V_{IC(R)}$	$V_{CC} = 30V$ ($V_{CC} = 26V$ for KA2902)	0		$V_{CC} - 2.0$	0		$V_{CC} - 2.0$	0		$V_{CC} - 2.0$	V
Large Signal Voltage Gain	G_V	$V_{CC} = 15V$, $R_L \geq 2.0K\Omega$ $V_{O(P)} = 1V$ to $11V$	25			15			15			V/mV
Output Voltage Swing	$V_{O(H)}$	$V_{CC} = 30V$ $V_{CC} = 26V$ for 2902	26			26			22			V
	$V_{O(L)}$	$R_L = 2K\Omega$ $R_L = 10K\Omega$	27	28		27	28		23	24		V
Output Current	I_{SOURCE}	$V_{I(+)} = 1V$, $V_{I(-)} = 0V$ $V_{CC} = 15V$, $V_{O(P)} = 2V$	10	20		10	20		10	20		mA
	I_{SINK}	$V_{I(+)} = 0V$, $V_{I(-)} = 1V$ $V_{CC} = 15V$, $V_{O(P)} = 2V$	10	13		5	8		5	8		mA
Differential Input Voltage	$V_{I(DIFS)}$				V_{CC}			V_{CC}			V_{CC}	V

LM224/A, LM324/A, LM2902 QUAD OPERATIONAL AMPLIFIER

ELECTRICAL CHARACTERISTICS

($V_{CC}=50V$, $V_{EE} = GND$, $T_A=25^\circ C$, unless otherwise specified)

Characteristic	Symbol	Test Conditions	LM224A			LM324A			Unit
			Min	Typ	Max	Min	Typ	Max	
Input Offset Voltage	V_{IO}	$V_{CM} = 0V$ to $V_{CC} = 1.5V$ $V_{O(P)} = 1.4V$, $R_S = 0 \Omega$		1.0	3.0		1.5	3.0	mV
Input Offset Current	I_{IO}			2	15		3.0	30	nA
Input Bias Current	I_{BIAS}			40	80		40	100	nA
Input Common-Mode Voltage Range	$V_{I(R)}$	$V_{CC} = 30V$	0		$V_{CC} - 1.5$	0		$V_{CC} - 1.5$	V
Supply Current (All Amps)	I_{CC}	$V_{CC} = 30V$		1.5	3		1.5	3	mA
		$V_{CC} = 5V$		0.7	1.2		0.7	1.2	mA
Large Signal Voltage Gain	G_V	$V_{CC} = 15V$, $R_L \geq 2 K\Omega$ $V_{O(P)} = 1V$ to $11V$	50	100		25	100		V/mV
Output Voltage Swing	$V_{O(H)}$	$V_{CC} = 30V$		26			26		V
		$V_{CC} = 26V$ for 2902		27	28		27	28	V
	$V_{O(L)}$	$V_{CC} = 5V$, $R_L \geq 10 K\Omega$		5	20		5	20	mV
Common-Mode Rejection Ratio	CMRR		70	85		65	85		dB
Power Supply Rejection Ratio	PSRR		65	100		65	100		dB
Channel Separation	CS	$f = 1KHz$ to $20KHz$		120			120		dB
Short Circuit to GND	I_{SC}			40	60		40	60	mA
Output Current	I_{SOURCE}	$V_{I(+)} = 1V$, $V_{I(-)} = 0V$ $V_{CC} = 15V$	20	40		20	40		mA
		$V_{I(+)} = 0V$, $V_{I(-)} = 1V$ $V_{CC} = 15V$, $V_{O(P)} = 2V$	10	20		10	20		mA
	I_{SINK}	$V_{I(+)} = 0V$, $V_{I(-)} = 1V$ $V_{CC} = 15V$, $V_{O(P)} = 200mV$	12	50		12	50		μA
Differential Input Voltage	$V_{I(DIFF)}$				V_{CC}			V_{CC}	V

LM224/A, LM324/A, LM2902 QUAD OPERATIONAL AMPLIFIER

ELECTRICAL CHARACTERISTICS

($V_{CC} = 5.0V$, $V_{EE} = GND$, unless otherwise specified)

The following specification apply over the range of $-25^{\circ}C \leq T_A \leq +85^{\circ}C$ for the LM224A; and the $0^{\circ}C \leq T_A \leq +70^{\circ}C$ for the LM324A

Characteristic	Symbol	Test Conditions	LM224A			LM324A			Unit
			Min	Typ	Max	Min	Typ	Max	
Input Offset Voltage	V_{IO}	$V_{CM} = 0V$ to $V_{CC} = 1.5V$ $V_{O(P)} = 1.4V$, $R_S = 0\Omega$			4.0			5.0	mV
Input Offset Voltage Drift	$\Delta V_{IO}/\Delta T$			7.0	20		7.0	30	$\mu V/^{\circ}C$
Input Offset Current	I_{IO}				30			75	nA
Input Offset Current Drift	$\Delta I_{IO}/\Delta T$			10	200		10	300	$pA/^{\circ}C$
Input Bias Current	I_{BIAS}			40	100		40	200	nA
Input Common-Mode Voltage Range	$V_{I(R)}$	$V_{CC} = 30V$	0		$V_{CC} - 2.0$	0		$V_{CC} - 2.0$	V
Large Signal Voltage Gain	G_V	$V_{CC} = 15V$, $R_L \geq 2.0K\Omega$	25			15			V/mV
Output Voltage Swing	$V_{O(P-P)}$	$V_{CC} = 30V$							V
		$R_L = 2K\Omega$	26			26			
		$R_L = 10K\Omega$	27	28		27	28		
		$V_{CC} = 5V$, $R_L \geq 10K\Omega$		5	20		5	20	mA
Output Current	I_{SOURCE}	$V_{I(+)} = 1V$, $V_{I(-)} = 0V$ $V_{CC} = 15V$	10	20		10	20		mA
	I_{SINK}	$V_{I(+)} = 0V$, $V_{I(-)} = 1V$ $V_{CC} = 15V$	5	8		5	8		mA
Differential Input Voltage	$V_{I(DIFF)}$				V_{CC}			V_{CC}	V

LM224/A, LM324/A, LM2902 QUAD OPERATIONAL AMPLIFIER

TYPICAL PERFORMANCE CHARACTERISTICS

Fig. 1 INPUT VOLTAGE RANGE

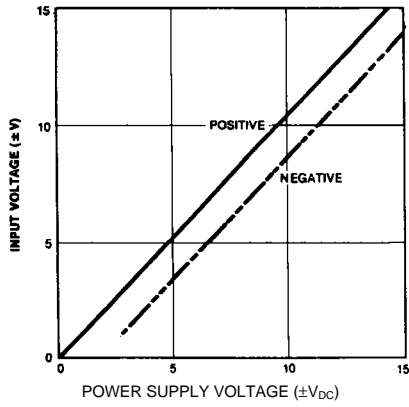

Fig. 2 INPUT CURRENT

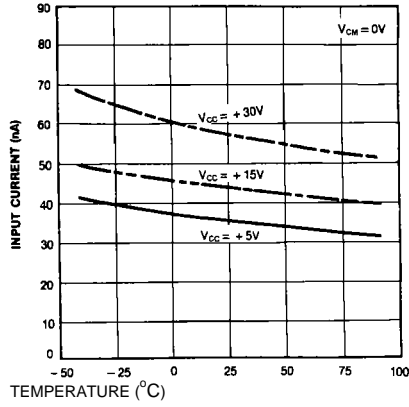

Fig. 3 SUPPLY CURRENT

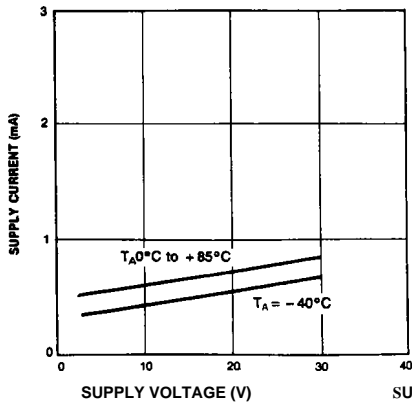

Fig. 4 VOLTAGE GAIN

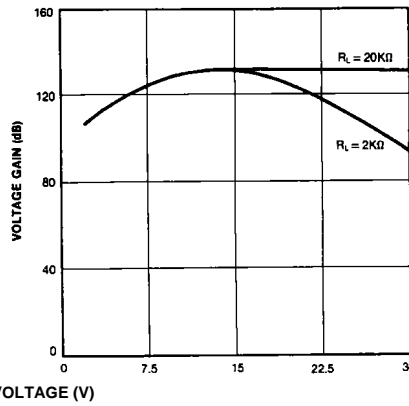

Fig. 5 OPEN LOOP FREQUENCY RESPONSE

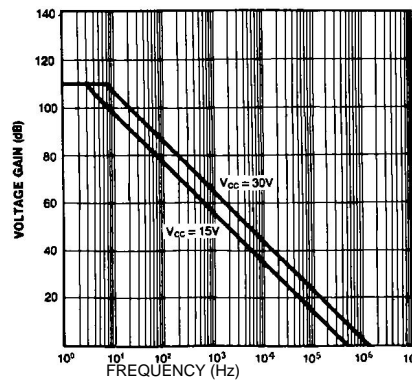
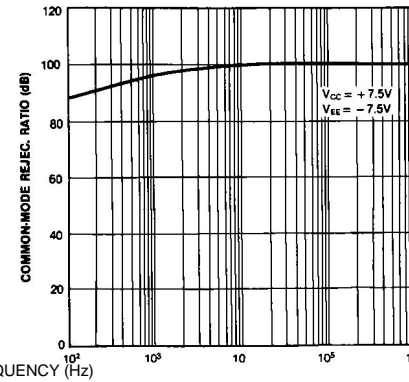

Fig. 6 COMMON-MODE REJECTION RATIO



LM224/A, LM324/A, LM2902 QUAD OPERATIONAL AMPLIFIER

Fig. 7 SLEW RATE

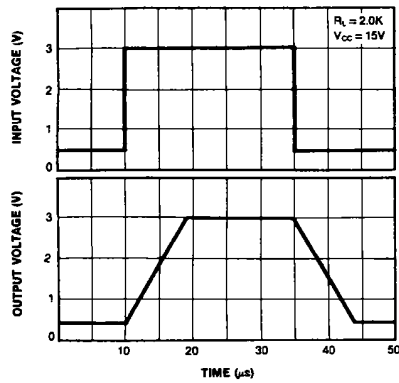

Fig. 8 VOLTAGE FOLLOWER PULSE

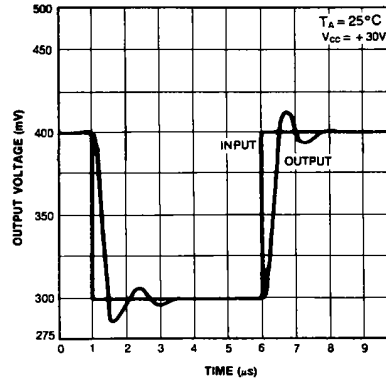

Fig. 9 LARGE SIGNAL FREQUENCY RESPONSE

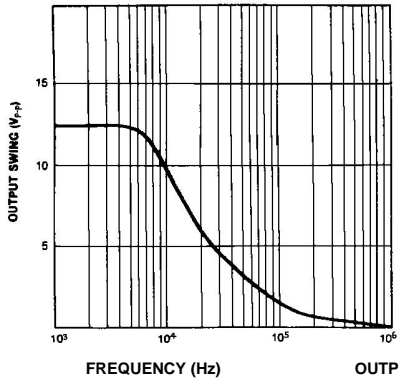

Fig. 10 OUTPUT CHARACTERISTICS

CURRENT SOURCING

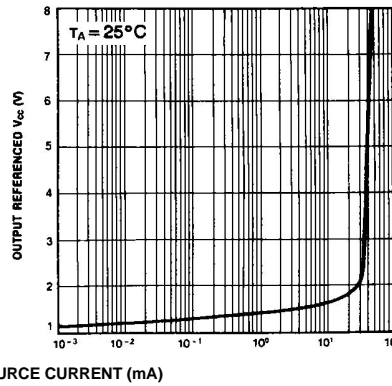

Fig. 11 OUTPUT CHARACTERISTICS CURRENT SINKING

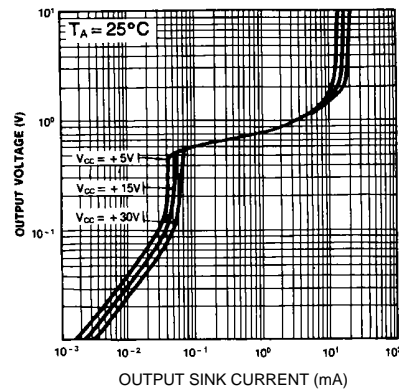
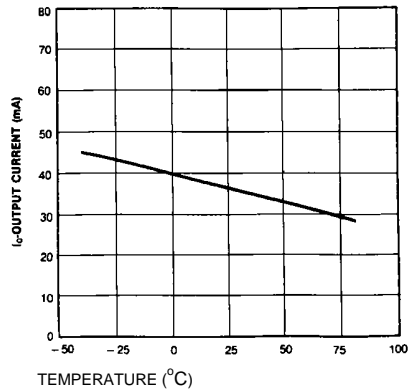

Fig. 12 CURRENT LIMITING



TRADEMARKS

The following are registered and unregistered trademarks Fairchild Semiconductor owns or is authorized to use and is not intended to be an exhaustive list of all such trademarks.

ACEx™	ISOPLANAR™
CoolFET™	MICROWIRE™
CROSSVOLT™	POP™
E ² CMOS™	PowerTrench™
FACT™	QS™
FACT Quiet Series™	Quiet Series™
FAST®	SuperSOT™-3
FASTr™	SuperSOT™-6
GTO™	SuperSOT™-8
HiSeC™	TinyLogic™

DISCLAIMER

FAIRCHILD SEMICONDUCTOR RESERVES THE RIGHT TO MAKE CHANGES WITHOUT FURTHER NOTICE TO ANY PRODUCTS HEREIN TO IMPROVE RELIABILITY, FUNCTION OR DESIGN. FAIRCHILD DOES NOT ASSUME ANY LIABILITY ARISING OUT OF THE APPLICATION OR USE OF ANY PRODUCT OR CIRCUIT DESCRIBED HEREIN; NEITHER DOES IT CONVEY ANY LICENSE UNDER ITS PATENT RIGHTS, NOR THE RIGHTS OF OTHERS.

LIFE SUPPORT POLICY

FAIRCHILD'S PRODUCTS ARE NOT AUTHORIZED FOR USE AS CRITICAL COMPONENTS IN LIFE SUPPORT DEVICES OR SYSTEMS WITHOUT THE EXPRESS WRITTEN APPROVAL OF FAIRCHILD SEMICONDUCTOR CORPORATION. As used herein:

1. Life support devices or systems are devices or systems which, (a) are intended for surgical implant into the body, or (b) support or sustain life, or (c) whose failure to perform when properly used in accordance with instructions for use provided in the labeling, can be reasonably expected to result in significant injury to the user.
2. A critical component is any component of a life support device or system whose failure to perform can be reasonably expected to cause the failure of the life support device or system, or to affect its safety or effectiveness.

PRODUCT STATUS DEFINITIONS

Definition of Terms

Datasheet Identification	Product Status	Definition
Advance Information	Formative or In Design	This datasheet contains the design specifications for product development. Specifications may change in any manner without notice.
Preliminary	First Production	This datasheet contains preliminary data, and supplementary data will be published at a later date. Fairchild Semiconductor reserves the right to make changes at any time without notice in order to improve design.
No Identification Needed	Full Production	This datasheet contains final specifications. Fairchild Semiconductor reserves the right to make changes at any time without notice in order to improve design.
Obsolete	Not In Production	This datasheet contains specifications on a product that has been discontinued by Fairchild semiconductor. The datasheet is printed for reference information only.