

## Features

- Low Voltage Programmable Logic Device
  - Wide Power Supply Range - 3.0V to 5.5V
  - Ideal for Battery Powered Systems
- High Speed Operation
  - 20 ns max Propagation Delay at  $V_{CC} = 3.0V$
- Commercial and Industrial Temperature Ranges
- Familiar 22V10 Logic Architecture
- Low Power 3-Volt CMOS Operation

	AT22LV10L	AT22LV10
Temp	Com./Ind.	Com./Ind.
$I_{CC}$ (mA)	4 / 5	35 / 45

$V_{CC} = 3.6V$

- CMOS and TTL Compatible Inputs and Outputs
  - 10  $\mu A$  Leakage Maximum
- Reprogrammable - Tested 100% for Programmability
- High Reliability CMOS Technology
  - 2000V ESD Protection
  - 200 mA Latchup Immunity
- Dual-In-Line and Surface Mount Packages

## Logic Diagram

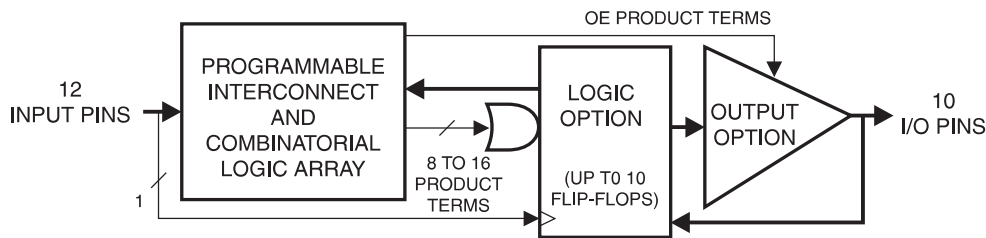

## Description

The AT22LV10 and AT22LV10L are low voltage compatible CMOS high performance Programmable Logic Devices (PLDs). Speeds down to 20 ns and power dissipation as low as 14.4 mW are offered. All speed ranges are specified over the 3.0V to 5.5V range. All pins offer a low  $\pm 10 \mu A$  leakage.

(continued)

## Pin Configurations

Pin Name	Function
CLK/IN	Clock and Logic Input
IN	Logic Inputs
I/O	Bidirectional Buffers
*	No Internal Connection
VCC	3.0V to 5.5V Supply

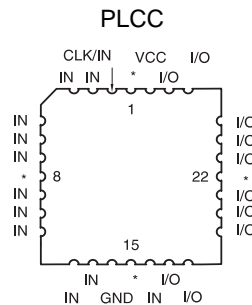
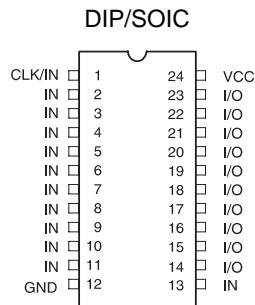

## Low-Voltage UV Erasable Programmable Logic Device

### AT22LV10 AT22LV10L



The AT22LV10L provides the optimum low power CMOS PLD solution, with low DC power (1 mA typical at  $V_{CC} = 3.3V$ ) and full CMOS output levels. The AT22LV10L significantly reduces total system power, allowing battery powered operation.

Full CMOS output levels help reduce power in many other system components.

The AT22LV10 and AT22LV10L logic architectures are identical to the familiar 22V10. Each output is allocated from eight to 16 product terms, which allows highly complex logic functions to be realized.

Two additional product terms are included to provide synchronous preset and asynchronous reset. These terms are common to all ten registers. All registers are automatically cleared upon power up.

Register preload simplifies testing. A security fuse prevents unauthorized copying of programmed fuse patterns.

## Absolute Maximum Ratings\*

Temperature Under Bias .....	-55°C to +125°C
Storage Temperature .....	-65°C to +150°C
Voltage on Any Pin with Respect to Ground .....	-2.0V to +7.0V <sup>(1)</sup>
Voltage on Input Pins with Respect to Ground During Programming .....	-2.0V to +14.0V <sup>(1)</sup>
Programming Voltage with Respect to Ground .....	-2.0V to +14.0V <sup>(1)</sup>
Integrated UV Erase Dose .....	7258 W-sec/cm <sup>2</sup>

\*NOTICE: Stresses beyond those listed under "Absolute Maximum Ratings" may cause permanent damage to the device. This is a stress rating only and functional operation of the device at these or any other conditions beyond those indicated in the operational sections of this specification is not implied. Exposure to absolute maximum rating conditions for extended periods may affect device reliability.

Note: 1. Minimum voltage is -0.6V dc which may undershoot to -2.0V for pulses of less than 20 ns. Maximum pin voltage is  $V_{CC} + 0.75V$  dc which may undershoot to  $V_{CC} + 2.0V$  for pulses of less than 20 ns.

## Logic Options

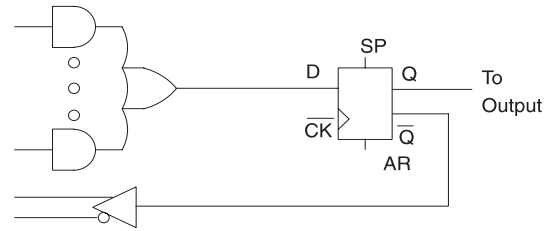
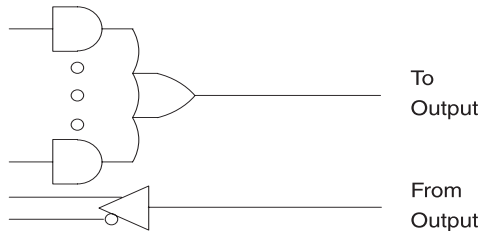

## Output Options

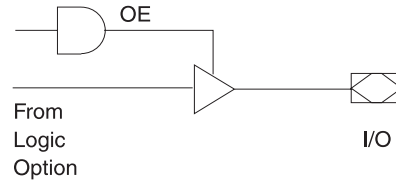
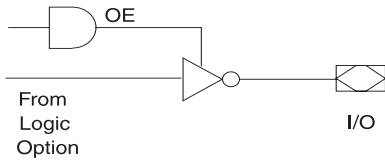

## DC and AC Operating Conditions

	Commercial	Industrial
Operating Temperature (Case)	0°C - 70°C	-40°C - 85°C
$V_{CC}$ Power Supply	3.0V to 5.5V	3.0V to 5.5V

## DC Characteristics

Symbol	Parameter	Condition	Min	Typ	Max	Units	
$I_{LI}$	Input Load Current	$V_{IN} = -0.1V$ to $V_{CC} + 1V$			10	$\mu A$	
$I_{LO}$	Output Leakage Current	$V_{OUT} = -0.1V$ to $V_{CC} + 0.1V$			10	$\mu A$	
$I_{CC}$	Power Supply Current	$V_{CC} = 3.6V / 5.5V,$ $V_{IN} = GND,$ Outputs Open	AT22LV10	Com.	20/50	35/90	mA
				Ind.	20/50	45/100	mA
			AT22LV10L	Com.	1/2	4/12	mA
				Ind.	1/2	5/15	mA
$I_{OS}^{(1)}$	Output Short Circuit Current	$V_{OUT} = 0.5V$			-120	mA	
$V_{IL1}$	Input Low Voltage	$4.5V \leq V_{CC} \leq 5.5V$	-0.6		0.8	V	
$V_{IL2}$	Input Low Voltage	$3.0V \leq V_{CC} < 4.5V$	-0.6		0.6	V	
$V_{IH}$	Input High Voltage		2.0		$V_{CC} + 0.75$	V	
$V_{OL}$	Output Low Voltage $V_{IN} = V_{IH}$ or $V_{IL}$	$V_{CC} = 3.0V$	Com.,Ind.	$I_{OL} = 8$ mA		0.5	V
		$V_{CC} = 4.5V$	Com.,Ind.	$I_{OL} = 16$ mA		0.5	V
		$V_{CC} = 3.0V$	Com.,Ind.	$I_{OL} = 6$ mA		0.35	V
$V_{OH}$	Output High Voltage	$V_{IN} = V_{IH}$ or $V_{IL},$ $V_{CC} = 3.0V / 4.5V$	$I_{OH} = -100 \mu A$		$V_{CC} - 0.3$		V
			$I_{OH} = -0.4$ mA / $-4.0$ mA		2.4		V

Note: 1. Not more than one output at a time should be shorted. Duration of short circuit test should not exceed 30 sec.

## AC Characteristics for the AT22LV10

Symbol	Parameter	AT22LV10-20			AT22LV10-25			Units
		Min	Typ	Max	Min	Typ	Max	
$t_{PD}$	Input or Feedback to Non-Registered Output		12	20		15	25	ns
$t_{EA}$	Input to Output Enable			20		15	25	ns
$t_{ER}$	Input to Output Disable			20		15	25	ns
$t_{CF}$	Clock to Feedback	0	4	9	0	5	9	ns
$t_{CO}$	Clock to Output	0	8	14	0	10	17	ns
$t_S$	Input or Feedback Setup Time	10	6		12	7		ns
$t_H$	Hold Time	0			0			ns
$t_P$	Clock Period	10			12			ns
$t_W$	Clock Width	5			6			ns
$F_{MAX}$	External Feedback $1/(t_S+t_{CO})$			41.6			34.5	MHz
	Internal Feedback $1/(t_S + t_{CF})$			52.6			47.6	MHz
	No Feedback $1/(t_P)$			100.0			83.3	MHz
$t_{AW}$	Asynchronous Reset Width	20	12		25	15		ns
$t_{AR}$	Asynchronous Reset, Synchronous Preset, Recovery Time	20	12		25	15		ns
$t_{AP}$	Asynchronous Reset to Registered Output Reset		15	25		18	28	ns

## AC Waveforms<sup>(1)</sup>

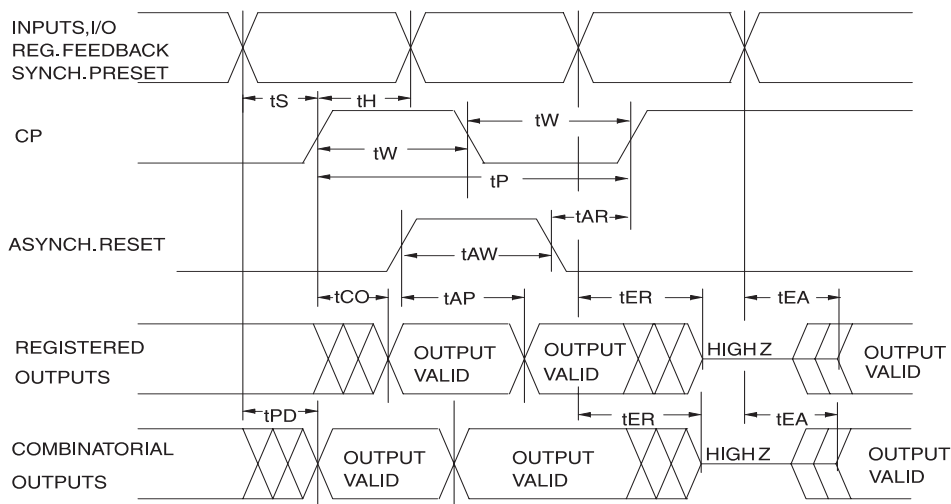

Note: 1. Timing measurement reference is 1.5V. Input AC driving levels are 0.0V and 3.0V, unless otherwise specified.

## AC Characteristics for the AT22LV10L

Symbol	Parameter	AT22LV10L-25			Units
		Min	Typ	Max	
$t_{PD}$	Input or Feedback to Non-Registered Output		15	25	ns
$t_{EA}$	Input to Output Enable		15	25	ns
$t_{ER}$	Input to Output Disable		15	25	ns
$t_{CF}$	Clock to Feedback	0	5	9	ns
$t_{CO}$	Clock to Output	0	10	14	ns
$t_{SF}$	Feedback Setup Time	12	7		ns
$t_S$	Input Setup Time	17	15		ns
$t_H$	Hold Time	0			ns
$t_P$	Clock Period	12			ns
$t_W$	Clock Width	6			ns
$F_{MAX}$	External Feedback $1/(t_S + t_{CO})$			32.2	MHz
	Internal Feedback $1/(t_{SF} + t_{CF})$			47.6	MHz
	No Feedback $1/(t_P)$			83.3	MHz
$t_{AW}$	Asynchronous Reset Width	25	15		ns
$t_{AR}$	Asynchronous Reset Recovery Time	25	15		ns
$t_{AP}$	Asynchronous Reset to Registered Output Reset		18	28	ns

## Input Test Waveforms and Measurement Levels

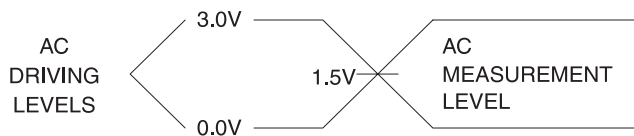

## Output Test Loads: Commercial

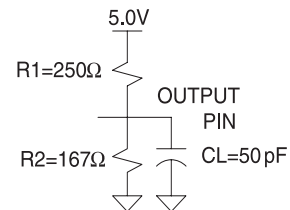

# Functional Logic Diagram AT22LV10(L)

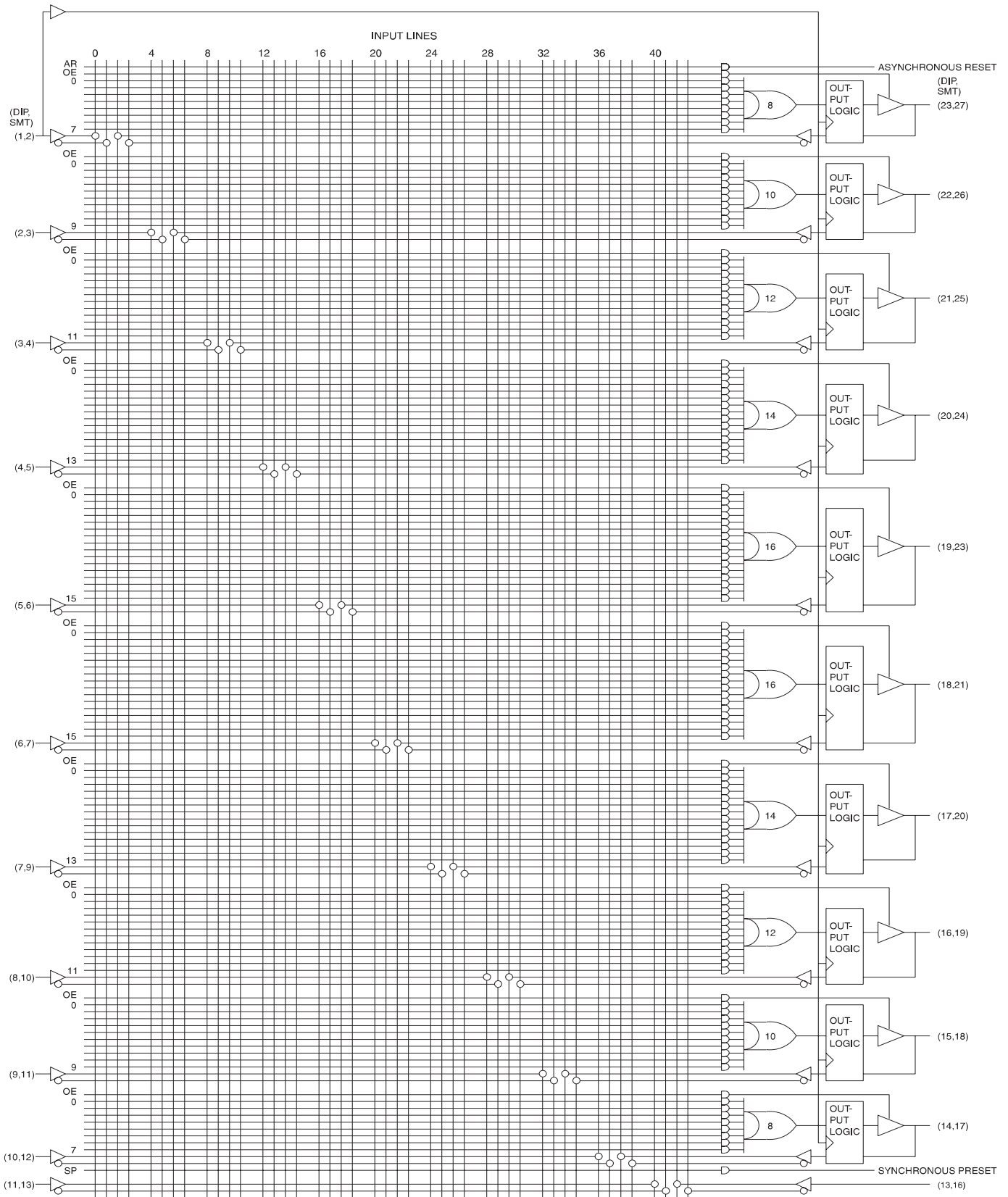

## Preload of Registered Outputs

The registers in the AT22LV10 and AT22LV10L are provided with circuitry to allow loading of each register asynchronously with either a high or a low. This feature will simplify testing since any state can be forced into the registers to control test sequencing. A  $V_{IH}$  level on the I/O pin will force the register high; a  $V_{IL}$  will force it low, independent of the polarity bit (C0) setting. The preload state is entered by placing an 11.5V to 13V signal on pin 8 on

DIPs, and pin 10 on SMPs. When the clock pin is pulsed high, the data on the I/O pins is placed into the ten registers.

Level forced on registered output pin during preload cycle	Register state after cycle
$V_{IH}$	High
$V_{IL}$	Low

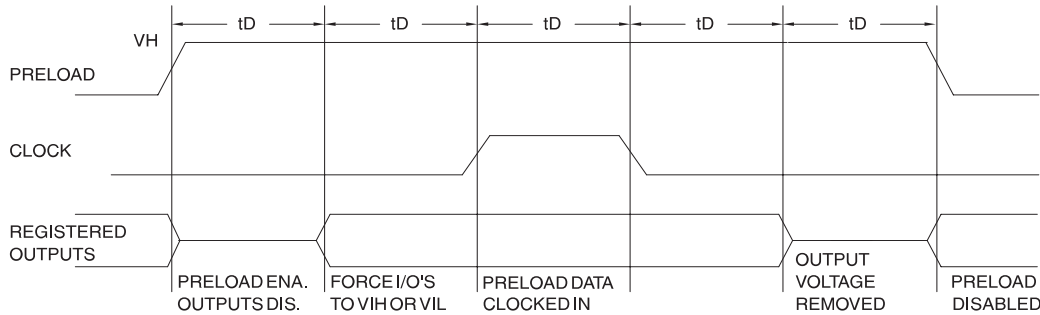

## Power-Up Reset

The registers in the AT22LV10 and AT22LV10L are designed to reset during power up. At a point delayed slightly from  $V_{CC}$  crossing 2.5V, all registers will be reset to the low state. The output state will depend on the polarity of the output buffer.

This feature is critical for state machine initialization. However, due to the asynchronous nature of reset and the uncertainty of how  $V_{CC}$  actually rises in the system, the following conditions are required:

1. The  $V_{CC}$  rise must be monotonic;
2. After reset occurs, all input and feedback setup times must be met before driving the clock pin high, and
3. The clock must remain stable during  $t_{PR}$ .

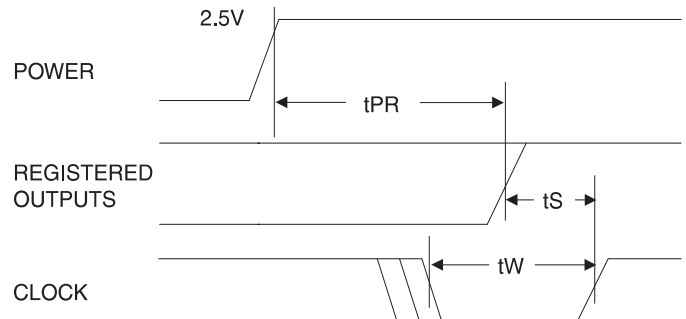

Parameter	Description	Min	Typ	Max	Units
$t_{PR}$	Power-Up Reset Time		600	1000	ns

## Pin Capacitance ( $f = 1 \text{ MHz}$ , $T = 25^\circ\text{C}$ )<sup>(1)</sup>

	Typ	Max	Units	Conditions
$C_{IN}$	5	8	pF	$V_{IN} = 0V$
$C_{OUT}$	6	8	pF	$V_{OUT} = 0V$

Note: 1. Typical values for nominal supply voltage. This parameter is only sampled and is not 100% tested.

## Erase Characteristics

The entire fuse array of an AT22LV10 or AT22LV10L is erased after exposure to ultraviolet light at a wavelength of 2537 Å. Complete erasure is assured after a minimum of 20 minutes exposure using 12,000  $\mu\text{W}/\text{cm}^2$  intensity lamps spaced one inch away from the chip. Minimum erase time for lamps at other intensity ratings can be calculated from

the minimum integrated erasure dose of 15  $\text{W}\cdot\text{sec}/\text{cm}^2$ . To prevent unintentional erasure, an opaque label is recommended to cover the clear window on any UV erasable PLD which will be subjected to continuous fluorescent indoor lighting or sunlight.

SUPPLY CURRENT vs. INPUT FREQUENCY

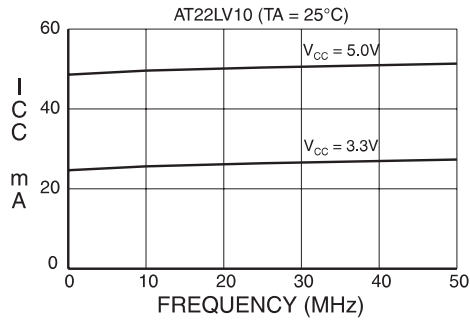

SUPPLY CURRENT vs. INPUT FREQUENCY

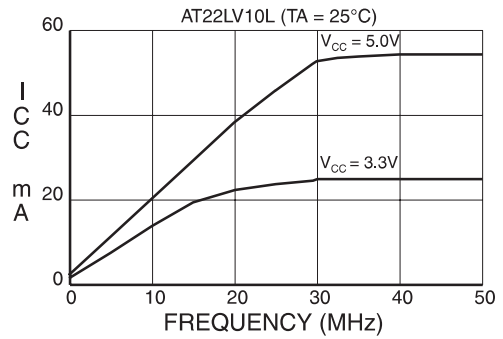

NORMALIZED SUPPLY CURRENT

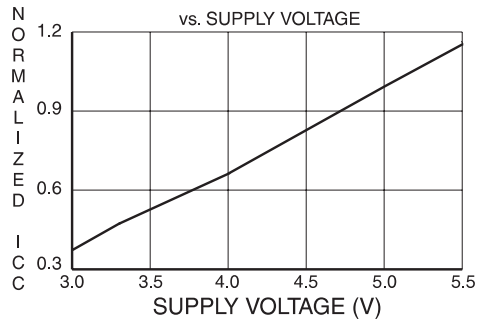

NORMALIZED ICC vs. AMBIENT TEMP.

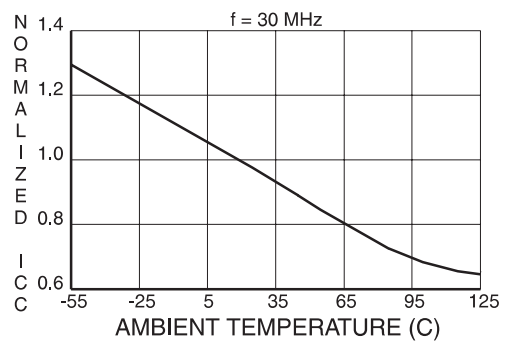

OUTPUT SINK CURRENT

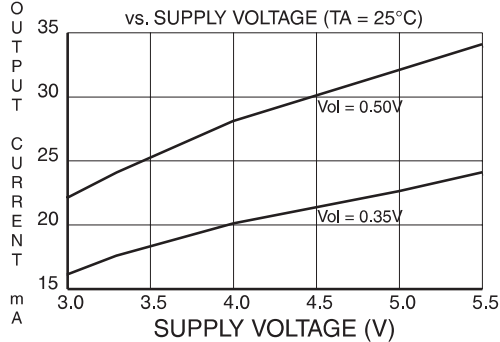

OUTPUT SINK CURRENT

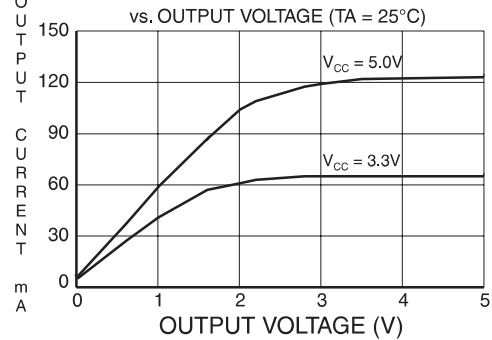

OUTPUT SOURCE CURRENT

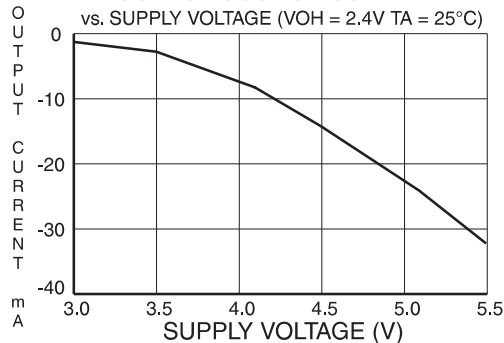

OUTPUT SOURCE CURRENT

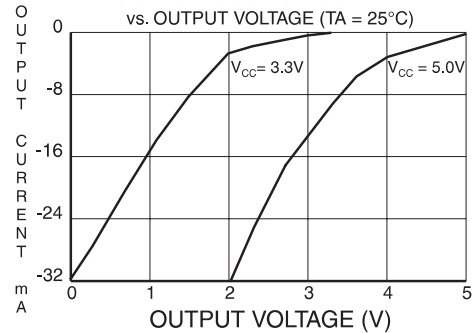

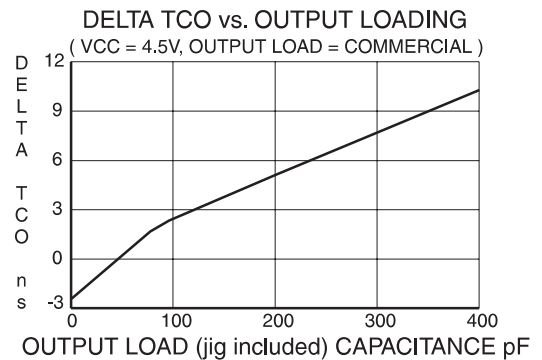
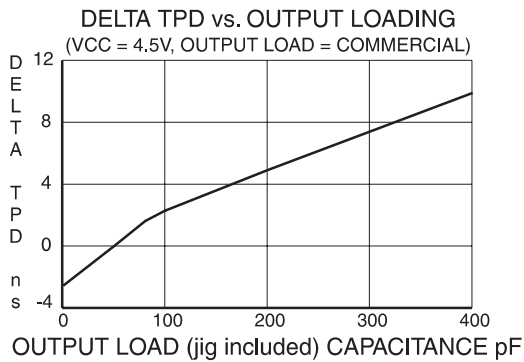
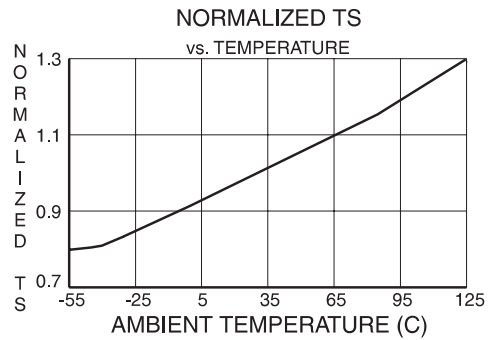
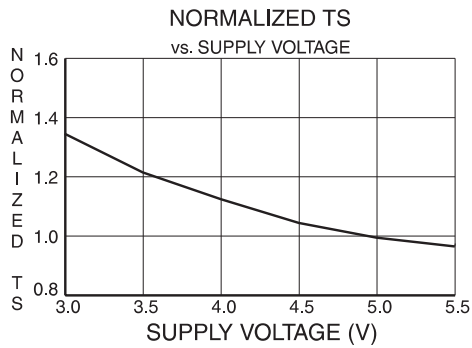
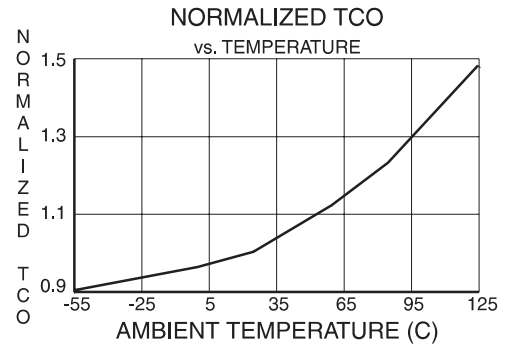
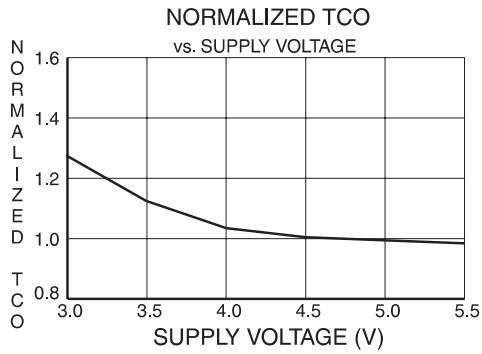
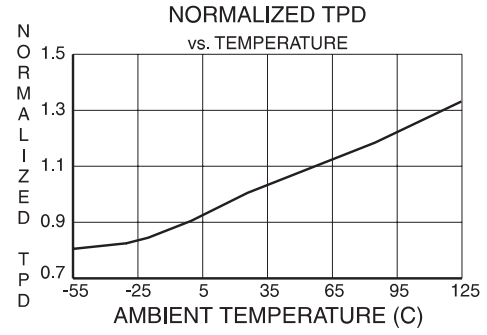
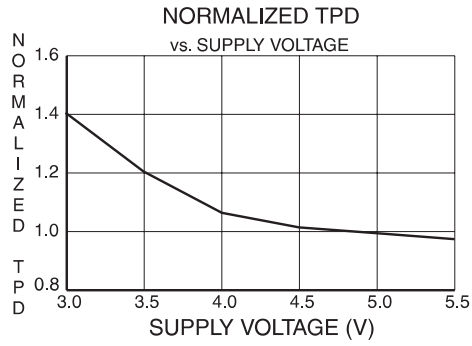



## Ordering Information

$t_{PD}$ (ns)	$t_S$ (ns)	$t_{CO}$ (ns)	Ordering Code	Package	Operation Range
20	10	14	AT22LV10-20JC AT22LV10-20PC AT22LV10-20SC	28J 24P3 24S	Commercial (0°C to 70°C)
			AT22LV10-20JI AT22LV10-20PI AT22LV10-20SI	28J 24P3 24S	Industrial (-40°C to 85°C)
25	12	17	AT22LV10-25JC AT22LV10-25PC AT22LV10-25SC	28J 24P3 24S	Commercial (0°C to 70°C)
			AT22LV10-25JI AT22LV10-25PI AT22LV10-25SI	28J 24P3 24S	Industrial (-40°C to 85°C)
25	17	14	AT22LV10L-25JC AT22LV10L-25PC AT22LV10L-25SC	28J 24P3 24S	Commercial (0°C to 70°C)
			AT22LV10L-25JI AT22LV10L-25PI AT22LV10L-25SI	28J 24P3 24S	Industrial (-40°C to 85°C)

Package Type	
<b>28J</b>	28-Lead, Plastic J-Leaded Chip Carrier OTP (PLCC)
<b>24P3</b>	24-Lead, 0.300" Wide, Plastic Dual Inline Package OTP (PDIP)
<b>24S</b>	24-Lead, 0.300" Wide, Plastic Gull Wing Small Outline OTP (SOIC)

## Packaging Information

**28J**, 28-Lead, Plastic J-Leaded Chip Carrier (PLCC)  
 Dimensions in Inches and (Millimeters)  
 JEDEC STANDARD MS-018 AB

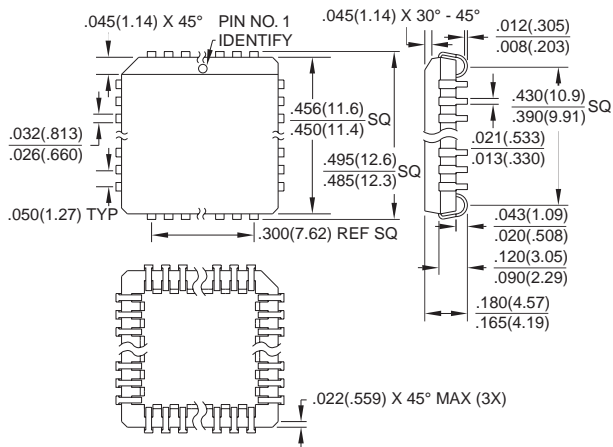

**24P3**, 24-Lead, 0.300" Wide, Plastic Dual Inline Package (PDIP)  
 Dimensions in Inches and (Millimeters)  
 JEDEC STANDARD MS-011 AB

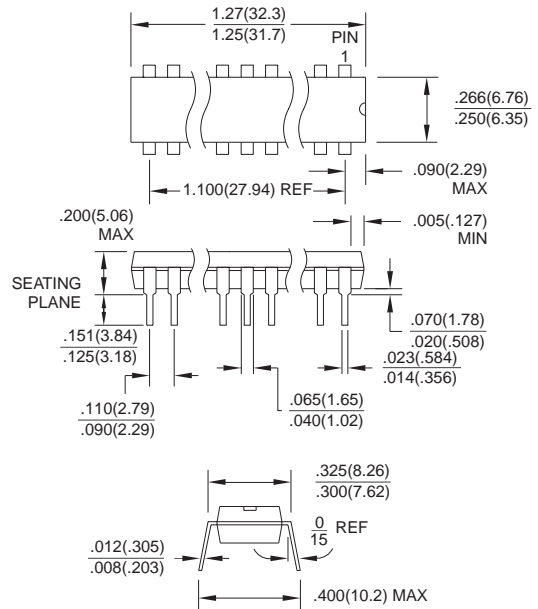

**24S**, 24-Lead, 0.300" Wide, Plastic Gull Wing Small Outline (SOIC)  
 Dimensions in Inches and (Millimeters)

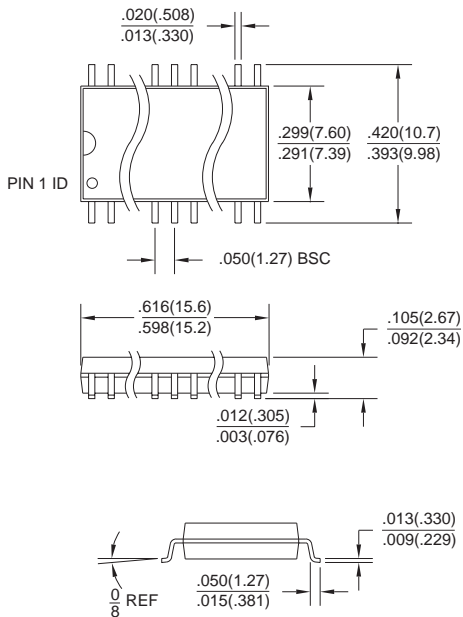

This datasheet has been downloaded from:

[www.DatasheetCatalog.com](http://www.DatasheetCatalog.com)

Datasheets for electronic components.



LittleDiode supplies new, hard to find or obsolete electronic components and semiconductors all over the world.

With over two million different components listed you are sure to find the part you need.

Feel free to visit us today at our online store:

[LittleDiode.com](http://LittleDiode.com)

Looking forward to providing you with the best possible service.