

SIPMOS[®] Power Transistor

- N channel
- Enhancement mode
- Avalanche-rated

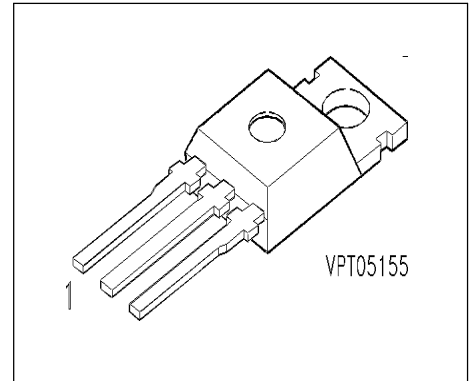

Pin 1	Pin 2	Pin 3
G	D	S

Type	V _{DS}	I _D	R _{DS(on)}	Package	Ordering Code
BUZ 77 A	600 V	2.7 A	4 Ω	TO-220 AB	C67078-S1320-A3

Maximum Ratings

Parameter	Symbol	Values	Unit
Continuous drain current $T_C = 31\text{ °C}$	I_D	2.7	A
Pulsed drain current $T_C = 25\text{ °C}$	I_{Dpuls}	11	
Avalanche current, limited by T_{jmax}	I_{AR}	2.7	
Avalanche energy, periodic limited by T_{jmax}	E_{AR}	5	mJ
Avalanche energy, single pulse $I_D = 2.7\text{ A}$, $V_{DD} = 50\text{ V}$, $R_{GS} = 25\text{ Ω}$ $L = 45.3\text{ mH}$, $T_j = 25\text{ °C}$	E_{AS}	180	
Gate source voltage	V_{GS}	± 20	V
Power dissipation $T_C = 25\text{ °C}$	P_{tot}	75	W
Operating temperature	T_j	-55 ... + 150	°C
Storage temperature	T_{stg}	-55 ... + 150	
Thermal resistance, chip case	R_{thJC}	≤ 1.67	K/W
Thermal resistance, chip to ambient	R_{thJA}	75	
DIN humidity category, DIN 40 040		E	
IEC climatic category, DIN IEC 68-1		55 / 150 / 56	

Electrical Characteristics, at $T_j = 25^\circ\text{C}$, unless otherwise specified

Parameter	Symbol	Values			Unit
		min.	typ.	max.	
Static Characteristics					
Drain- source breakdown voltage $V_{GS} = 0\text{ V}$, $I_D = 0.25\text{ mA}$, $T_j = 25\text{ }^\circ\text{C}$	$V_{(BR)DSS}$	600	-	-	V
Gate threshold voltage $V_{GS} = V_{DS}$, $I_D = 1\text{ mA}$	$V_{GS(th)}$	2.1	3	4	
Zero gate voltage drain current $V_{DS} = 600\text{ V}$, $V_{GS} = 0\text{ V}$, $T_j = 25\text{ }^\circ\text{C}$ $V_{DS} = 600\text{ V}$, $V_{GS} = 0\text{ V}$, $T_j = 125\text{ }^\circ\text{C}$	I_{DSS}	-	0.1 10	1 100	μA
Gate-source leakage current $V_{GS} = 20\text{ V}$, $V_{DS} = 0\text{ V}$	I_{GSS}	-	10	100	nA
Drain-Source on-resistance $V_{GS} = 10\text{ V}$, $I_D = 1.7\text{ A}$	$R_{DS(on)}$	-	3.5	4	Ω

Electrical Characteristics, at $T_j = 25^\circ\text{C}$, unless otherwise specified

Parameter	Symbol	Values			Unit
		min.	typ.	max.	
Dynamic Characteristics					
Transconductance $V_{DS} \geq 2 \cdot I_D \cdot R_{DS(on)max}$, $I_D = 1.7 \text{ A}$	g_{fs}	1.5	3	-	S
Input capacitance $V_{GS} = 0 \text{ V}$, $V_{DS} = 25 \text{ V}$, $f = 1 \text{ MHz}$	C_{iss}	-	460	690	pF
Output capacitance $V_{GS} = 0 \text{ V}$, $V_{DS} = 25 \text{ V}$, $f = 1 \text{ MHz}$	C_{oss}	-	55	85	
Reverse transfer capacitance $V_{GS} = 0 \text{ V}$, $V_{DS} = 25 \text{ V}$, $f = 1 \text{ MHz}$	C_{rss}	-	20	30	
Turn-on delay time $V_{DD} = 30 \text{ V}$, $V_{GS} = 10 \text{ V}$, $I_D = 2 \text{ A}$ $R_{GS} = 50 \Omega$	$t_{d(on)}$	-	8	12	ns
Rise time $V_{DD} = 30 \text{ V}$, $V_{GS} = 10 \text{ V}$, $I_D = 2 \text{ A}$ $R_{GS} = 50 \Omega$	t_r	-	30	40	
Turn-off delay time $V_{DD} = 30 \text{ V}$, $V_{GS} = 10 \text{ V}$, $I_D = 2 \text{ A}$ $R_{GS} = 50 \Omega$	$t_{d(off)}$	-	50	65	
Fall time $V_{DD} = 30 \text{ V}$, $V_{GS} = 10 \text{ V}$, $I_D = 2 \text{ A}$ $R_{GS} = 50 \Omega$	t_f	-	30	40	

Electrical Characteristics, at $T_j = 25^\circ\text{C}$, unless otherwise specified

Parameter	Symbol	Values			Unit
		min.	typ.	max.	
Reverse Diode					
Inverse diode continuous forward current $T_C = 25^\circ\text{C}$	I_S	-	-	2.7	A
Inverse diode direct current, pulsed $T_C = 25^\circ\text{C}$	I_{SM}	-	-	11	
Inverse diode forward voltage $V_{GS} = 0\text{ V}, I_F = 5.4\text{ A}$	V_{SD}	-	0.95	1.3	V
Reverse recovery time $V_R = 100\text{ V}, I_F = I_S, di_F/dt = 100\text{ A}/\mu\text{s}$	t_{rr}	-	350	-	ns
Reverse recovery charge $V_R = 100\text{ V}, I_F = I_S, di_F/dt = 100\text{ A}/\mu\text{s}$	Q_{rr}	-	3.5	-	μC

Power dissipation

$$P_{\text{tot}} = f(T_C)$$

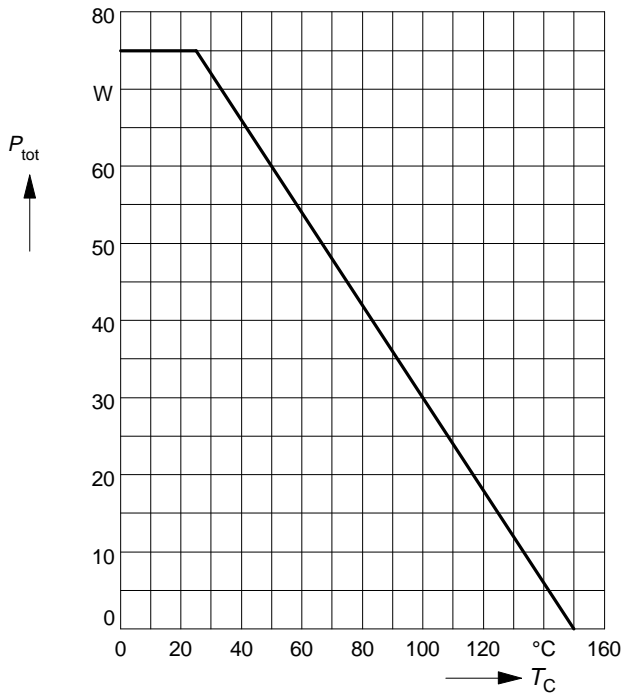

Drain current

$$I_D = f(T_C)$$

parameter: $V_{GS} \geq 10 \text{ V}$

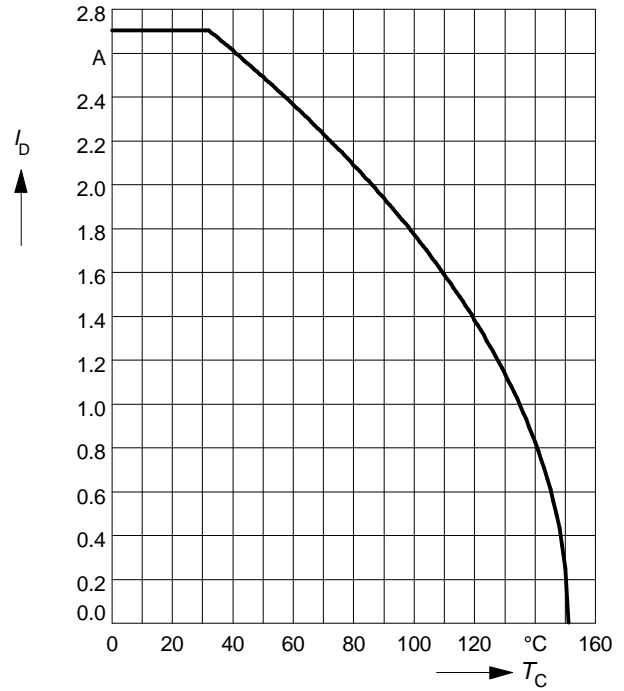

Safe operating area

$$I_D = f(V_{DS})$$

parameter: $D = 0.01, T_C = 25^\circ\text{C}$

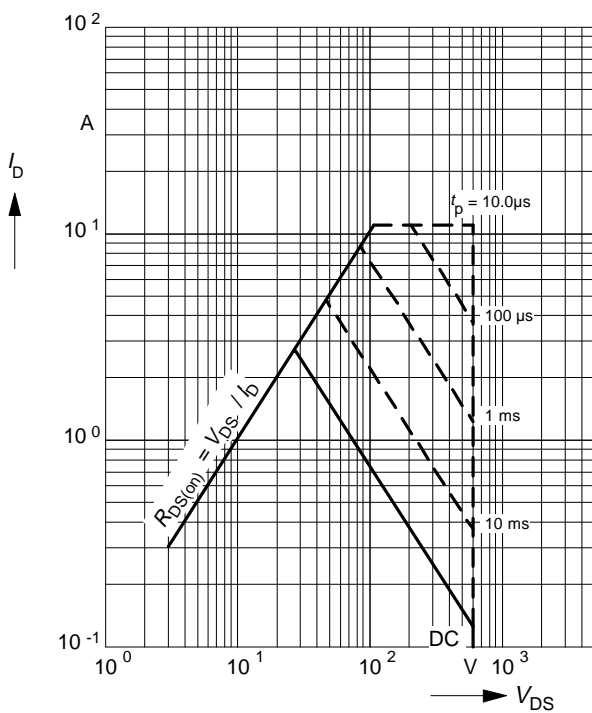

Transient thermal impedance

$$Z_{\text{thJC}} = f(t_p)$$

parameter: $D = t_p / T$

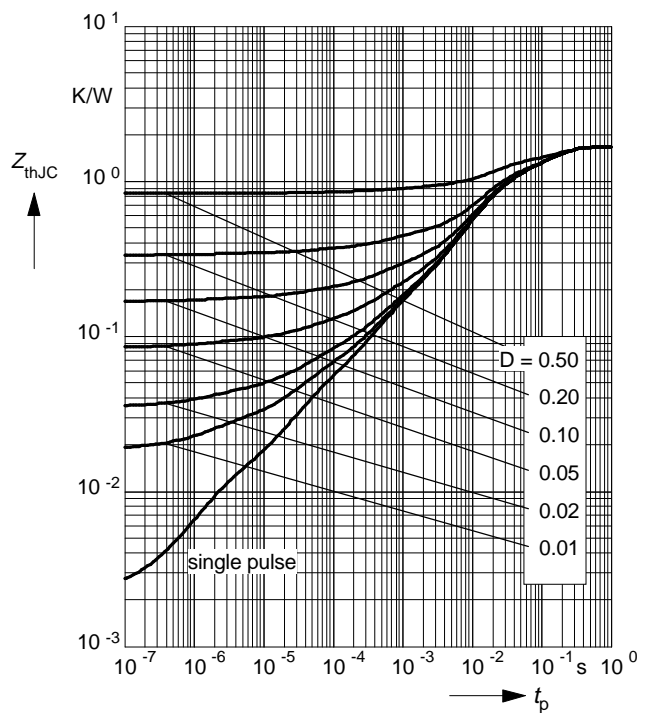

Typ. output characteristics

$$I_D = f(V_{DS})$$

parameter: $t_p = 80 \mu s$

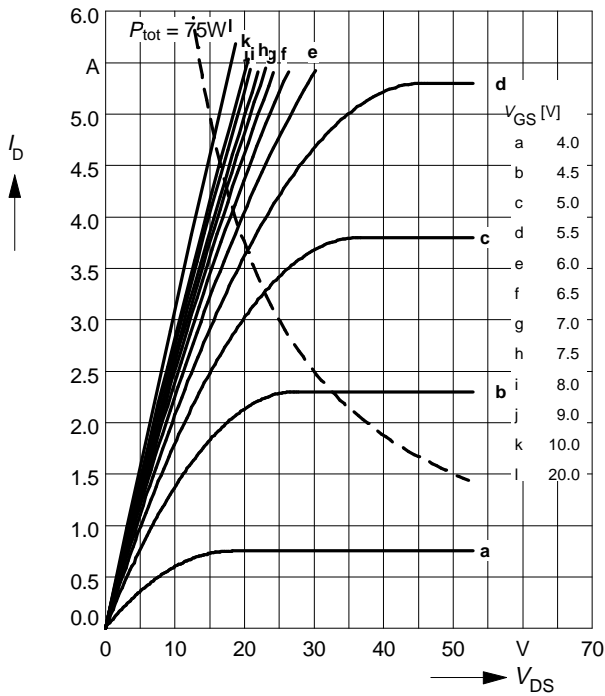

Typ. drain-source on-resistance

$$R_{DS(on)} = f(I_D)$$

parameter: V_{GS}

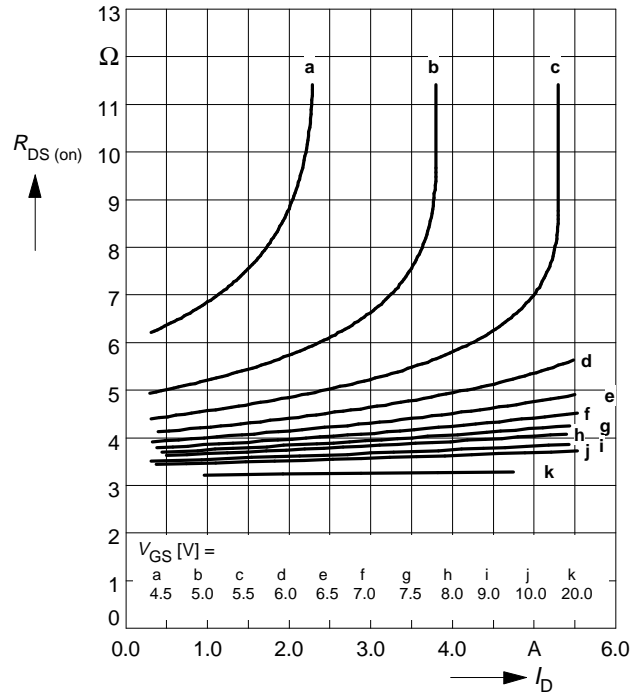

Typ. transfer characteristics $I_D = f(V_{GS})$

parameter: $t_p = 80 \mu s$

$$V_{DS} \geq 2 \times I_D \times R_{DS(on)max}$$

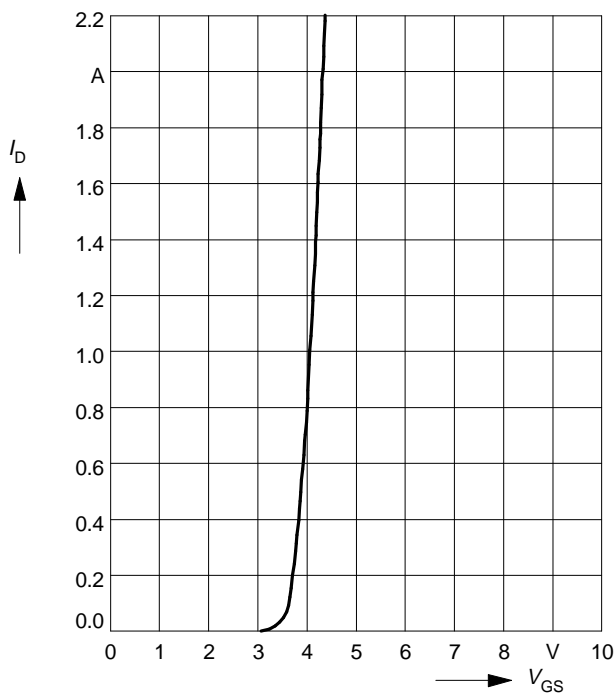

Typ. forward transconductance $g_{fs} = f(I_D)$

parameter: $t_p = 80 \mu s$,

$$V_{DS} \geq 2 \times I_D \times R_{DS(on)max}$$

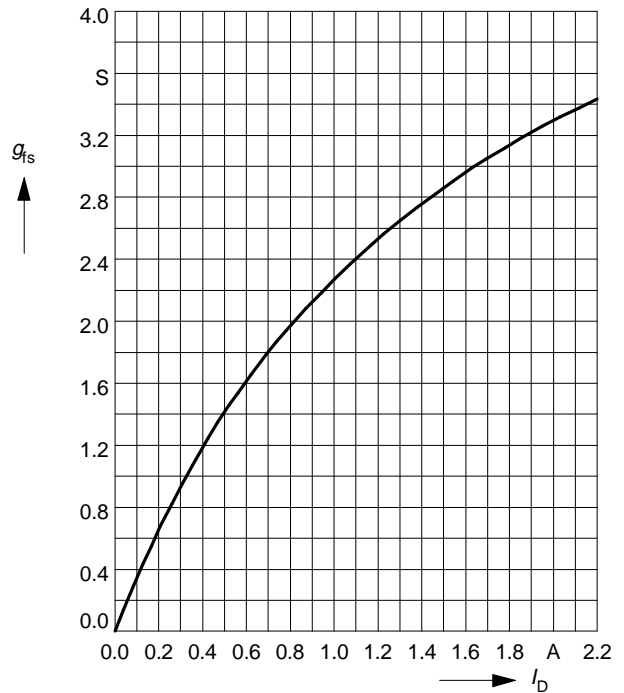

Drain-source on-resistance

$$R_{DS(on)} = f(T_j)$$

parameter: $I_D = 1.7 \text{ A}$, $V_{GS} = 10 \text{ V}$

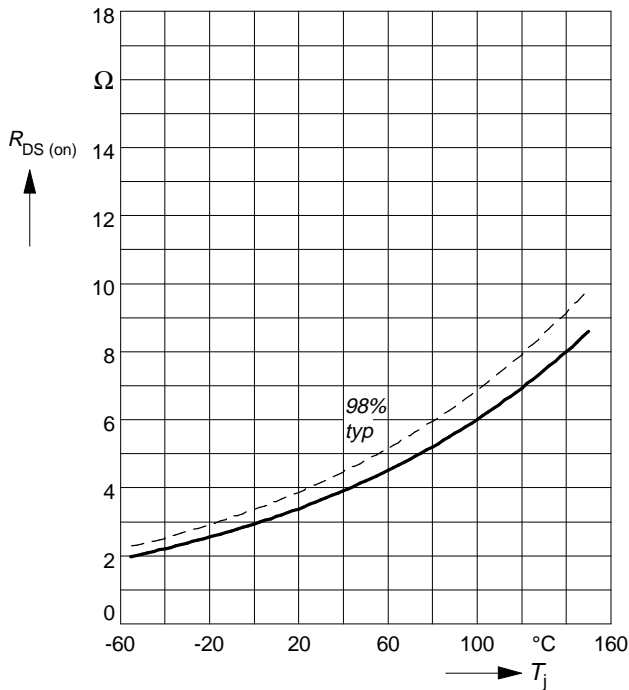

Gate threshold voltage

$$V_{GS(th)} = f(T_j)$$

parameter: $V_{GS} = V_{DS}$, $I_D = 1 \text{ mA}$

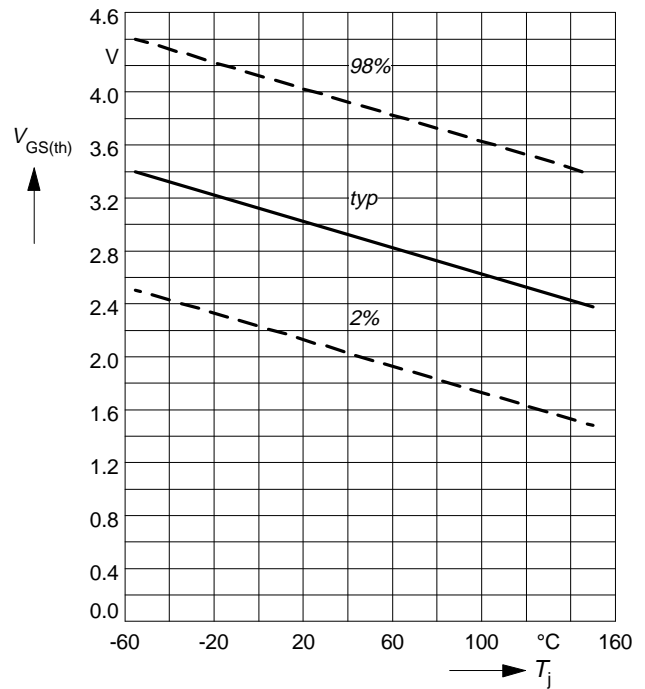

Typ. capacitances

$$C = f(V_{DS})$$

parameter: $V_{GS} = 0 \text{ V}$, $f = 1 \text{ MHz}$

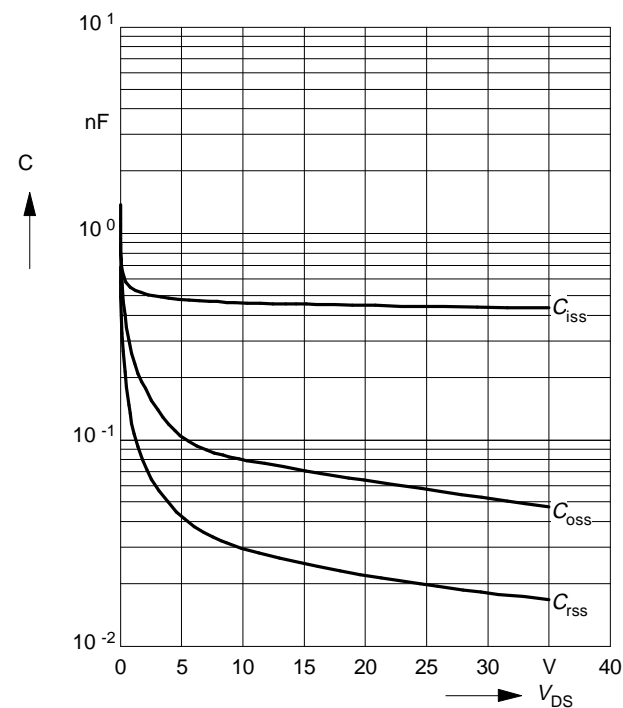

Forward characteristics of reverse diode

$$I_F = f(V_{SD})$$

parameter: T_j , $t_p = 80 \mu\text{s}$

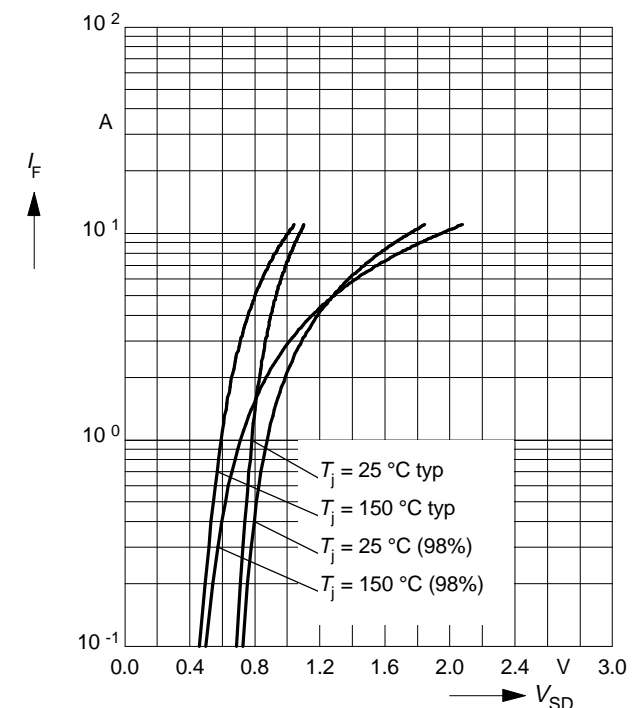

Avalanche energy $E_{AS} = f(T_j)$

parameter: $I_D = 2.7 \text{ A}$, $V_{DD} = 50 \text{ V}$

$R_{GS} = 25 \Omega$, $L = 45.3 \text{ mH}$

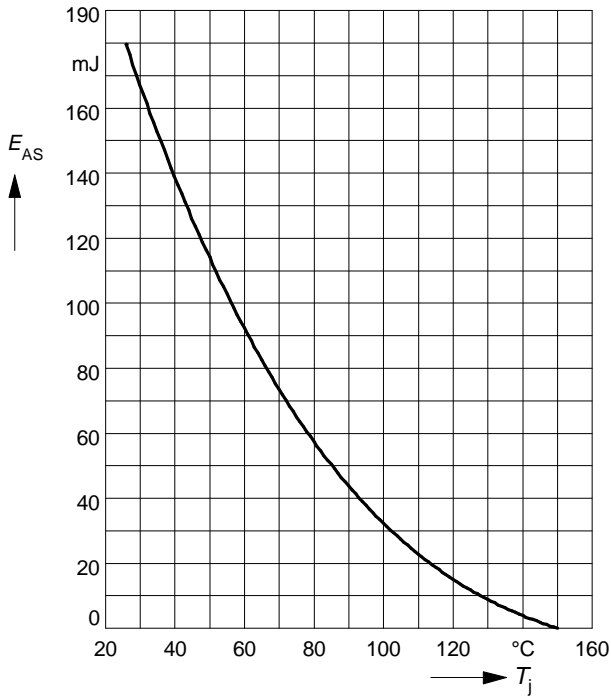

Typ. gate charge

$V_{GS} = f(Q_{Gate})$

parameter: $I_{D \text{ puls}} = 4 \text{ A}$

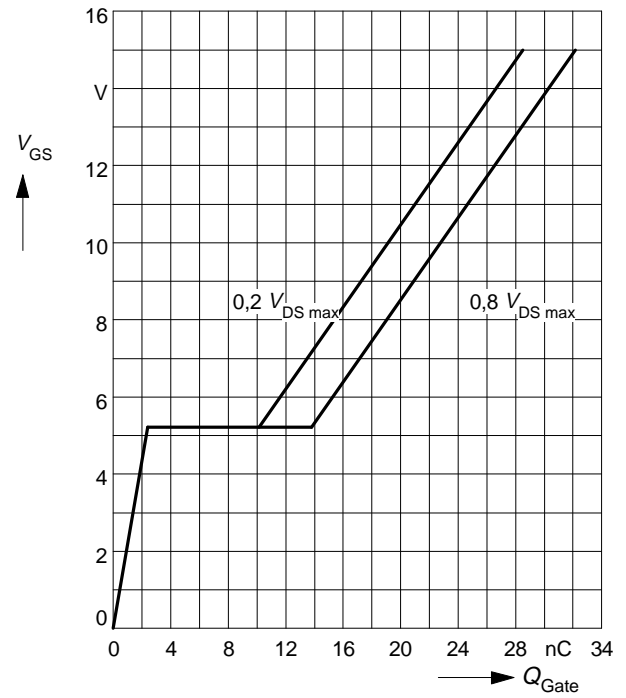

Drain-source breakdown voltage

$V_{(BR)DSS} = f(T_j)$

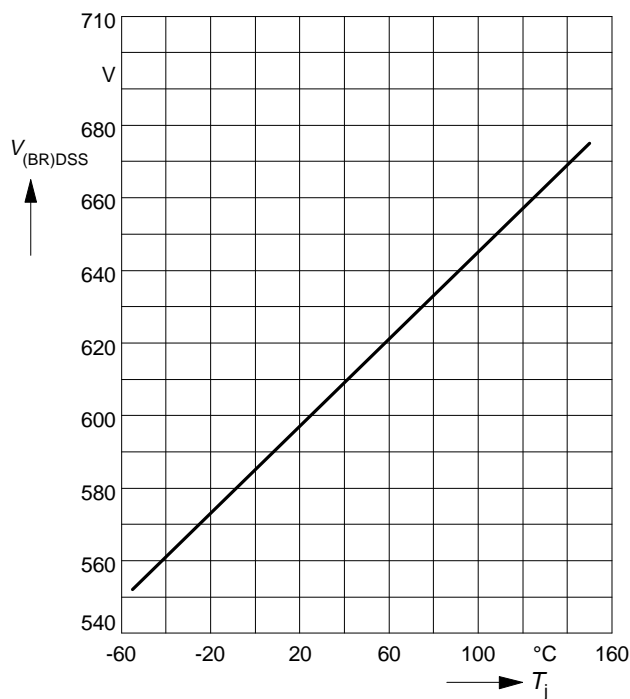

Package Outlines

TO-220 AB

Dimension in mm

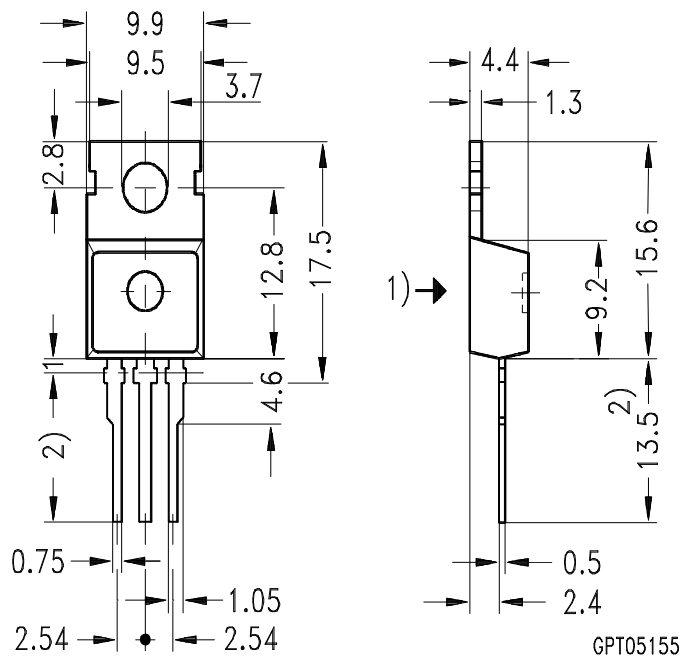

- 1) punch direction, burr max. 0.04
- 2) dip tinning
- 3) max. 14.5 by dip tinning press burr max. 0.05



LittleDiode supplies new, hard to find or obsolete electronic components and semiconductors all over the world.

With over two million different components listed you are sure to find the part you need.

Feel free to visit us today at our online store:

LittleDiode.com

Looking forward to providing you with the best possible service.