

TOSHIBA FIELD EFFECT TRANSISTOR SILICON N-CHANNEL DUAL GATE MOS TYPE

3SK294

TV TUNER, VHF RF AMPLIFIER APPLICATION

Unit in mm

- Superior Cross Modulation Performance
- Low Reverse Transfer Capacitance : $C_{rss} = 20\text{fF}$ (Typ.)
- Low Noise Figure : $NF = 1.4\text{dB}$ (Typ.)

MAXIMUM RATINGS ($T_a = 25^\circ\text{C}$)

CHARACTERISTIC	SYMBOL	RATING	UNIT
Drain-Source Voltage	V_{DS}	12.5	V
Gate 1-Source Voltage	V_{G1S}	± 8	V
Gate 2-Source Voltage	V_{G2S}	± 8	V
Drain Current	I_D	30	mA
Drain Power Dissipation	P_D	100	mW
Channel Temperature	T_{ch}	125	$^\circ\text{C}$
Storage Temperature Range	T_{stg}	$-55 \sim 125$	$^\circ\text{C}$

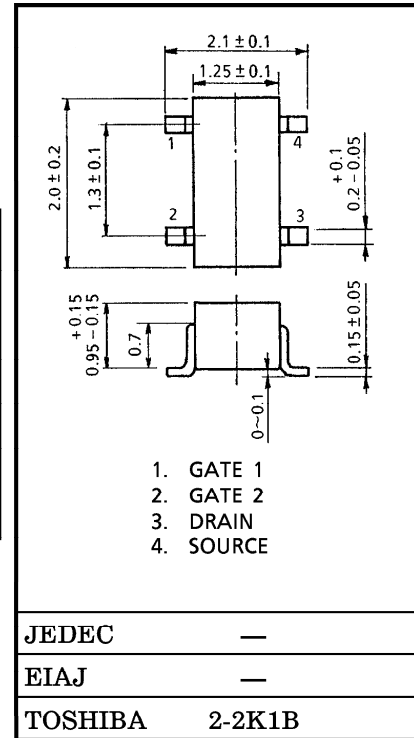

MARKING

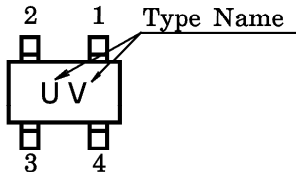

ELECTRICAL CHARACTERISTICS ($T_a = 25^\circ\text{C}$)

CHARACTERISTIC	SYMBOL	TEST CONDITION	MIN.	TYP.	MAX.	UNIT
Gate 1 Leakage Current	I_{G1SS}	$V_{DS} = 0, V_{G1S} = \pm 6\text{V}, V_{G2S} = 0$	—	—	± 50	nA
Gate 2 Leakage Current	I_{G2SS}	$V_{DS} = 0, V_{G1S} = 0, V_{G2S} = \pm 6\text{V}$	—	—	± 50	nA
Drain-Source Voltage	$V_{(BR)DSX}$	$V_{G1S} = -0.5\text{V}, V_{G2S} = -0.5\text{V}, I_D = 100\mu\text{A}$	12.5	—	—	V
Drain Current	I_{DSS}	$V_{DS} = 6\text{V}, V_{G1S} = 0, V_{G2S} = 4.5\text{V}$	—	—	0.1	mA
Gate 1-Source Cut-off Voltage	$V_{G1S(OFF)}$	$V_{DS} = 6\text{V}, V_{G2S} = 4.5\text{V}, I_D = 100\mu\text{A}$	0.3	0.9	1.3	V
Gate 2-Source Cut-off Voltage	$V_{G2S(OFF)}$	$V_{DS} = 6\text{V}, V_{G2S} = 4.0\text{V}, I_D = 100\mu\text{A}$	0.5	1.0	1.5	V
Forward Transfer Admittance	$ Y_{fs} $	$V_{DS} = 6\text{V}, V_{G2S} = 4.5\text{V}, I_D = 10\text{mA}, f = 1\text{kHz}$	19.5	23.5	—	mS
Input Capacitance	C_{iss}	$V_{DS} = 6\text{V}, V_{G2S} = 4.5\text{V}, I_D = 10\text{mA}, f = 1\text{MHz}$	—	2.5	3.1	pF
Reverse Transfer Capacitance	C_{rss}		—	20	40	fF
Power Gain	G_{ps}	$V_{DS} = 6\text{V}, V_{G2S} = 4.5\text{V}, I_D = 10\text{mA}, f = 500\text{MHz}$	23.5	26.0	—	dB
Noise Figure	NF		—	1.4	2.5	

961001EAA2

- TOSHIBA is continually working to improve the quality and the reliability of its products. Nevertheless, semiconductor devices in general can malfunction or fail due to their inherent electrical sensitivity and vulnerability to physical stress. It is the responsibility of the buyer, when utilizing TOSHIBA products, to observe standards of safety, and to avoid situations in which a malfunction or failure of a TOSHIBA product could cause loss of human life, bodily injury or damage to property. In developing your designs, please ensure that TOSHIBA products are used within specified operating ranges as set forth in the most recent products specifications. Also, please keep in mind the precautions and conditions set forth in the TOSHIBA Semiconductor Reliability Handbook.
- The information contained herein is presented only as a guide for the applications of our products. No responsibility is assumed by TOSHIBA CORPORATION for any infringements of intellectual property or other rights of the third parties which may result from its use. No license is granted by implication or otherwise under any intellectual property or other rights of TOSHIBA CORPORATION or others.
- The information contained herein is subject to change without notice.

Fig.1 G_{ps}/NF TEST CIRCUIT

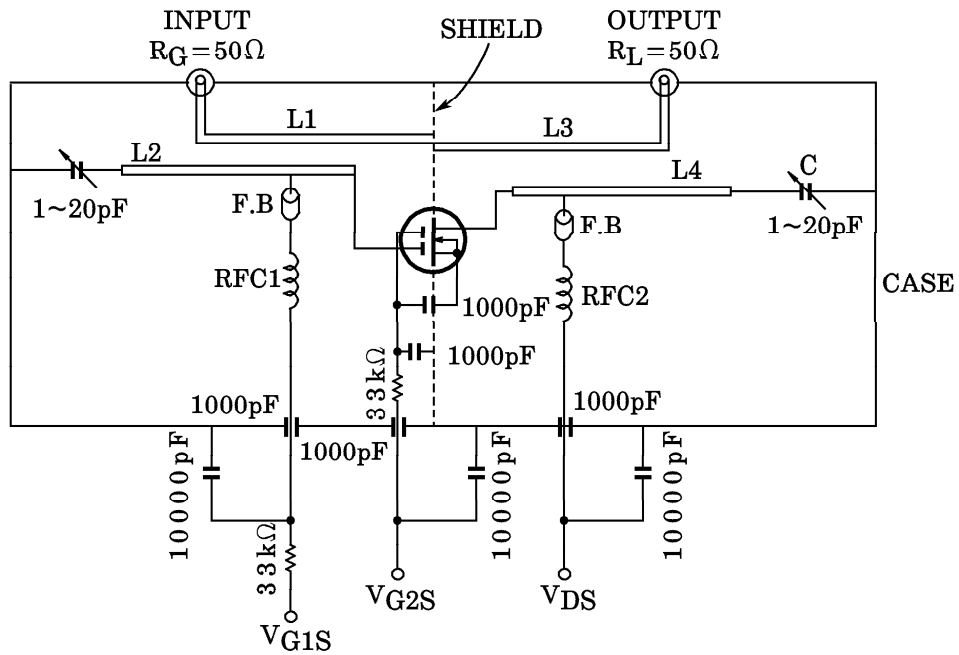

- L1~L4 : ϕ 0.8mm SILVER PLATED COPPER WIRE
- C : AIR TRIMMER TTA25A200A (MURATA MFG, Co., Ltd.)
- RFC 1 : ϕ 0.35mm VEW 3I.D.7T
- RFC 2 : ϕ 0.35mm VEW 3I.D.10T

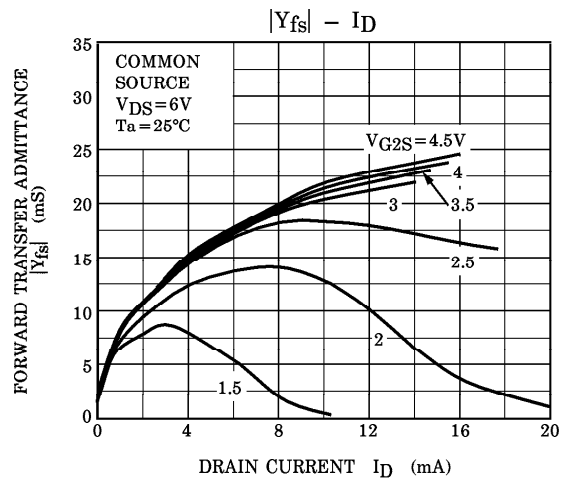
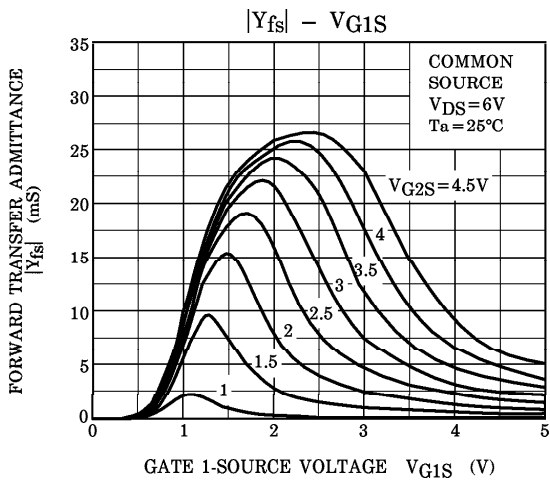
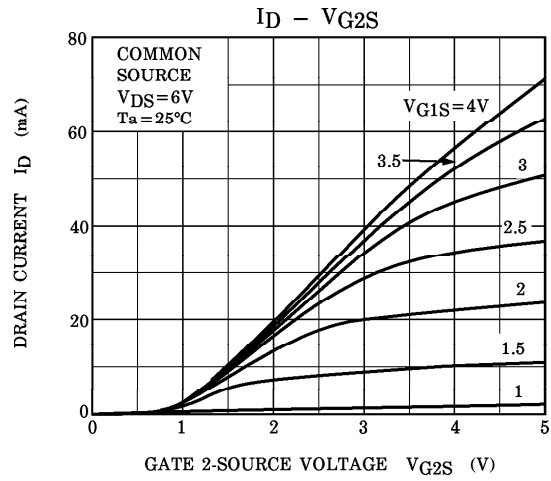
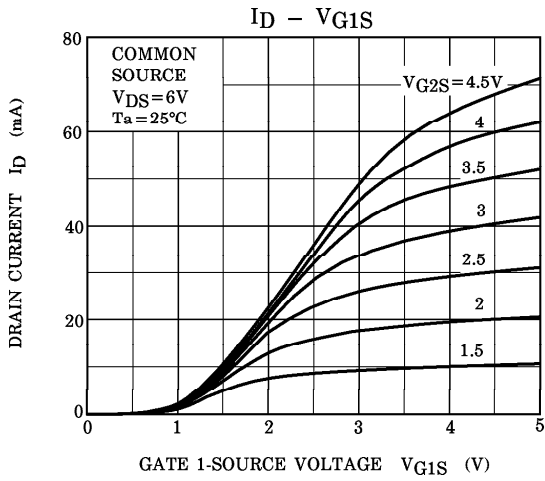
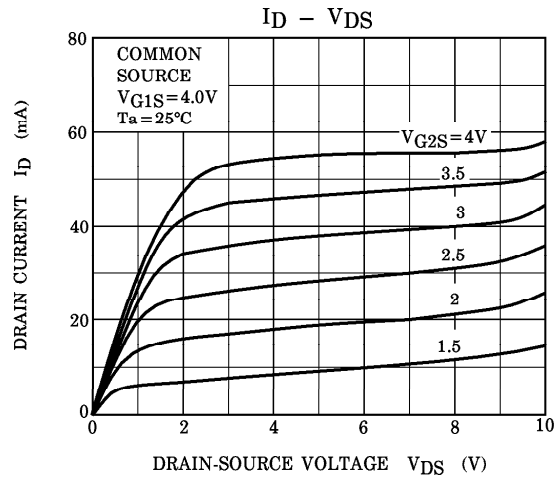
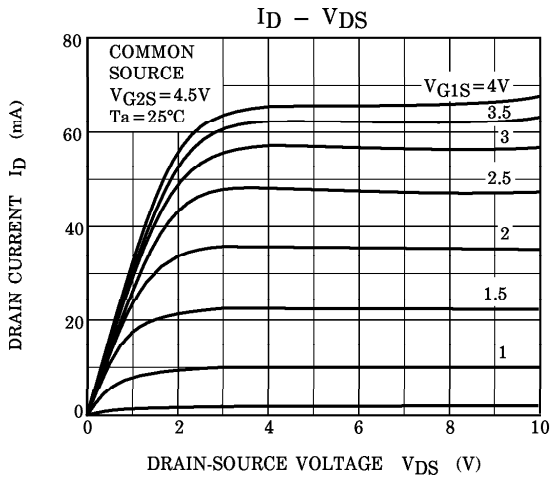

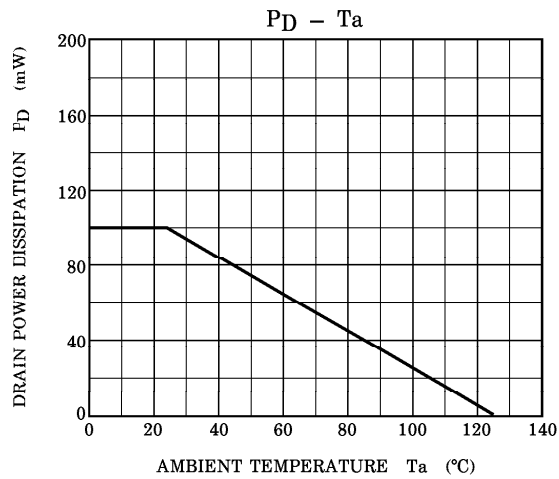
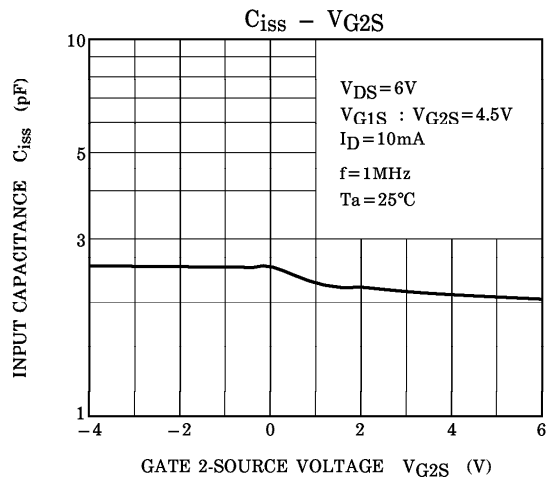
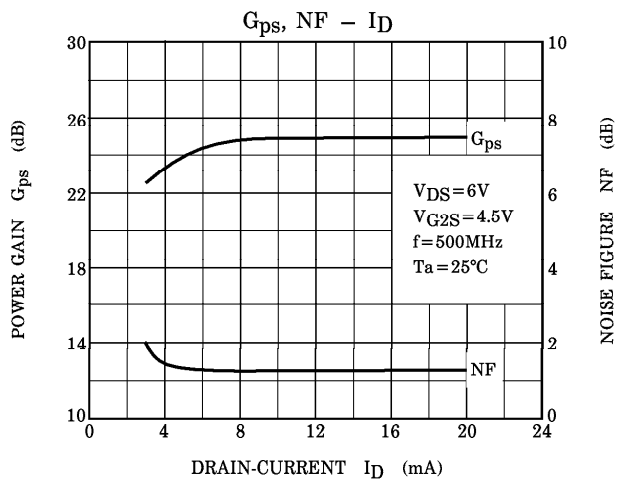
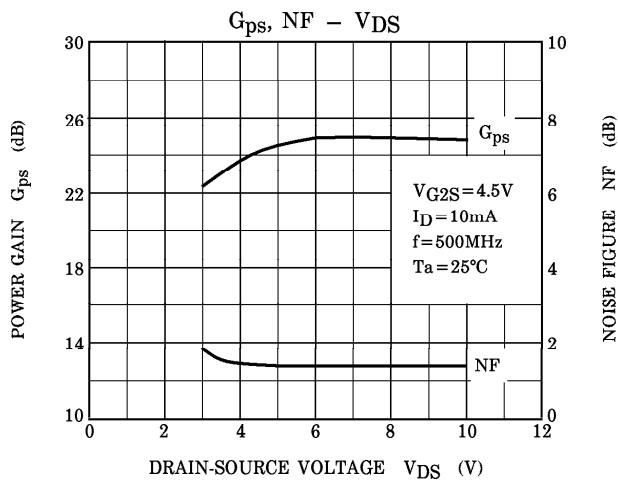

This datasheet has been downloaded from:

www.DatasheetCatalog.com

Datasheets for electronic components.



LittleDiode supplies new, hard to find or obsolete electronic components and semiconductors all over the world.

With over two million different components listed you are sure to find the part you need.

Feel free to visit us today at our online store:

LittleDiode.com

Looking forward to providing you with the best possible service.