

BC183LC

BC183LC

NPN General purpose Amplifier.

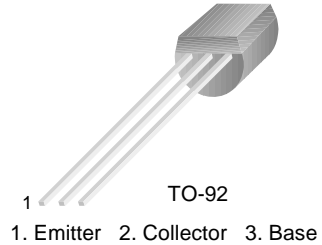

Absolute Maximum Ratings $T_C=25^\circ\text{C}$ unless otherwise noted

| Symbol | Parameter | Value | Units |
|-----------|--|------------|------------------|
| V_{CBO} | Collector-Base Voltage | 45 | V |
| V_{CEO} | Collector-Emitter Voltage | 30 | V |
| V_{EBO} | Emitter-Base Voltage | 5 | V |
| I_C | Collector Current (DC) | 100 | mA |
| P_C | Collector Dissipation ($T_a=25^\circ\text{C}$) | 350 | mW |
| T_J | Junction Temperature | 150 | $^\circ\text{C}$ |
| T_{STG} | Storage Temperature | - 55 ~ 150 | $^\circ\text{C}$ |

Electrical Characteristics $T_C=25^\circ\text{C}$ unless otherwise noted

| Symbol | Parameter | Test Condition | Min. | Typ. | Max. | Units |
|---------------|--------------------------------------|---|-----------------|------|-------------|-------|
| BV_{CBO} | Collector-Base Voltage | $I_C = 10\mu\text{A}$ | 45 | | | V |
| BV_{CEO} | Collector-Emitter Voltage | $I_C = 2\text{mA}$ | 30 | | | V |
| BV_{EBO} | Emitter-Base Voltage | $I_E = 10\mu\text{A}$ | 5 | | | V |
| I_{CBO} | Collector Cut-off Current | $V_{CB} = 30\text{V}$ | | | 15 | nA |
| I_{EBO} | Emitter Cut-off Current | $V_{EB} = 3\text{V}$ | | | 15 | nA |
| h_{FE} | DC Current Gain | $V_{CE} = 5\text{V}, I_C = 10\mu\text{A}$ $V_{CE} = 5\text{V}, I_C = 2\text{mA}$ $V_{CE} = 5\text{V}, I_C = 100\text{mA}$ | 40 100 80 | | 850 | |
| $V_{CE(sat)}$ | Collector-Emitter Saturation Voltage | $I_C = 10\text{mA}, I_B = 0.5\text{mA}$ $I_C = 100\text{mA}, I_B = 5\text{mA}$ | | | 0.25 0.6 | V |
| $V_{BE(sat)}$ | Base-Emitter Saturation Voltage | $I_C = 100\text{mA}, I_B = 5\text{mA}$ | | | 1.2 | V |
| $V_{BE(on)}$ | Base-Emitter On Voltage | $V_{CE} = 5\text{V}, I_C = 2\text{mA}$ | 0.55 | | 0.7 | V |
| C_{OB} | Output Capacitance | $V_{CE} = 10\text{V}, f = 1\text{MHz}$ | | | 5 | pF |
| f_T | Current gain Bandwidth Product | $V_{CE} = 5\text{V}, I_C = 10\text{mA}$ | 150 | | | MHz |
| h_{fe} | Small Signal Current Gain | $V_{CE} = 5\text{V}, I_C = 2\text{mA}$ $f = 1\text{KHz}$ | 450 | | 900 | |
| NF | Noise Figure | $V_{CE} = 5\text{V}, I_C = 200\text{mA}$ $R_G = 2\text{K}\Omega, f = 1\text{KHz}$ | | | 10 | dB |

Typical Characteristics

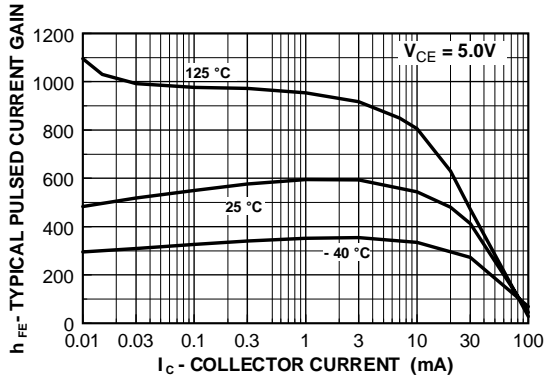

Figure 1. Typical Pulsed Current Gain vs Collector Current

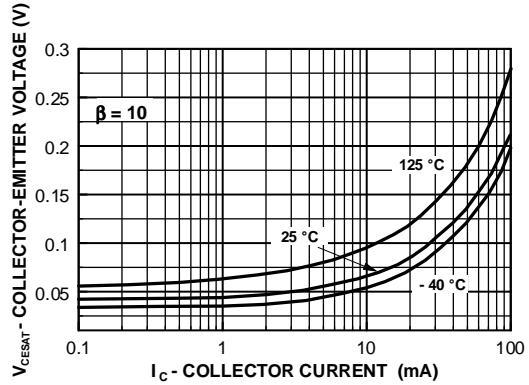

Figure 2. Collector-Emitter Saturation Voltage vs Collector Current

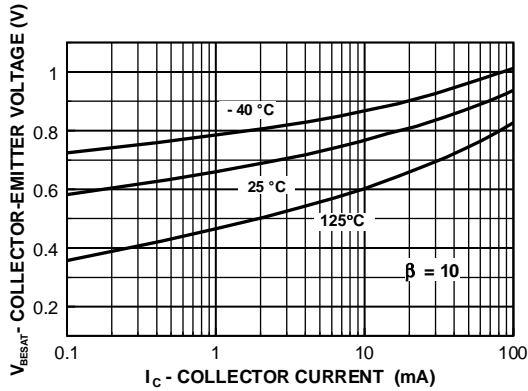

Figure 3. Base-Emitter Saturation Voltage vs Collector Current

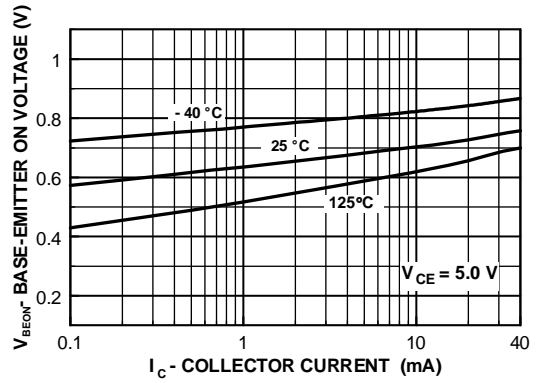

Figure 4. Base-Emitter ON Voltage vs Collector Current

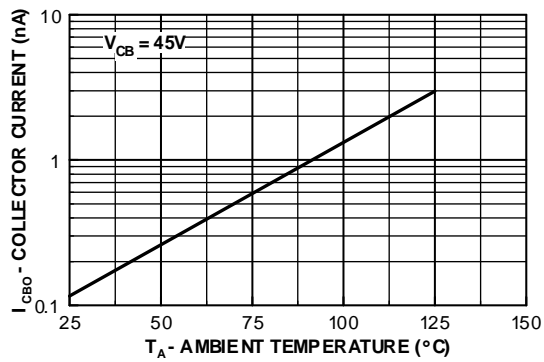

Figure 5. Collector-Cutoff Current vs Ambient Temperature

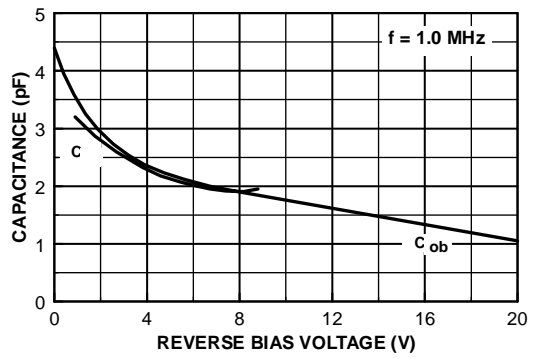

Figure 6. Input and Output Capacitance vs Reverse Bias Voltage

Typical Characteristics (Continued)

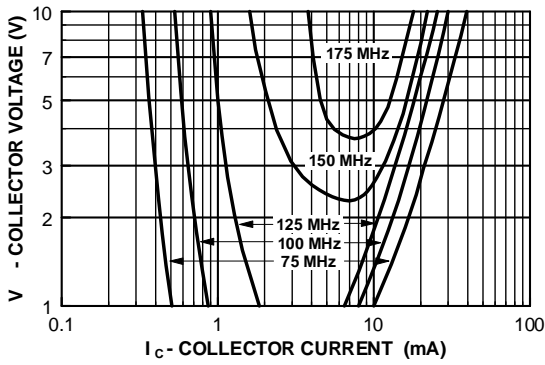

Figure 7. Contours of Constant Gain Bandwidth Product (f_T)

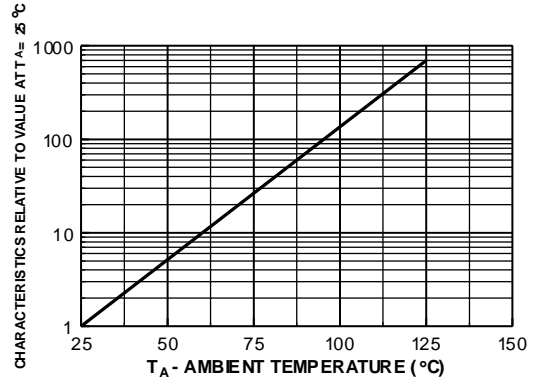

Figure 8. Normalized Collector-Cutoff Current vs Ambient Temperature

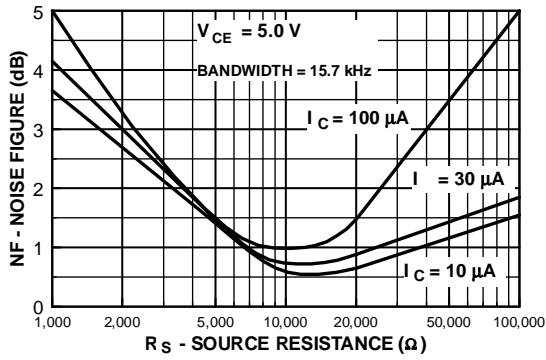

Figure 9. Wideband Noise Frequency vs Source Resistance

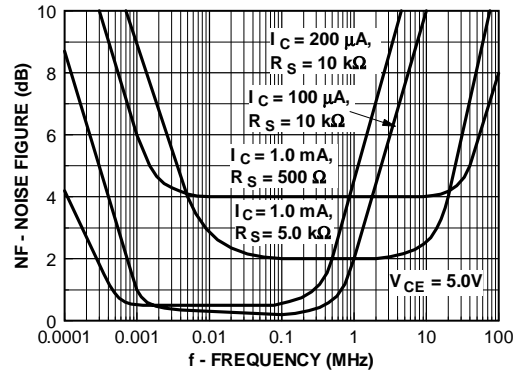

Figure 10. Noise Figure vs Frequency

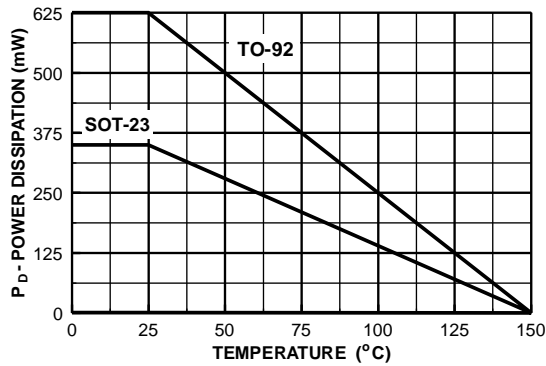

Figure 11. Collector-Cutoff Current vs Ambient Temperature

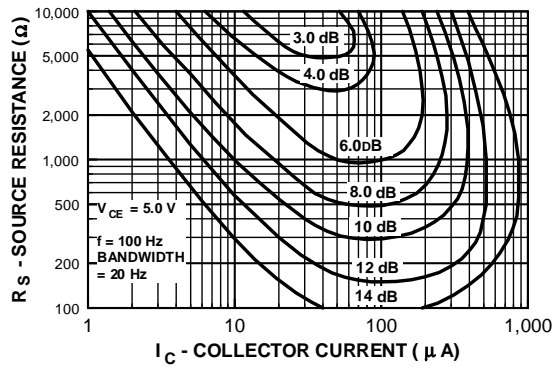

Figure 12. Contours of Constant Narrow Band Noise Figure

Typical Characteristics (Continued)

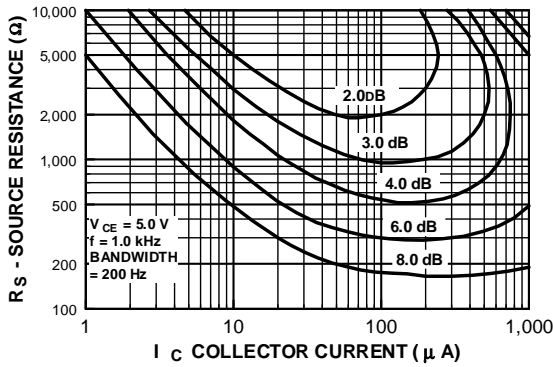

Figure 13. Contours of Constant Narrow Band Noise Figure

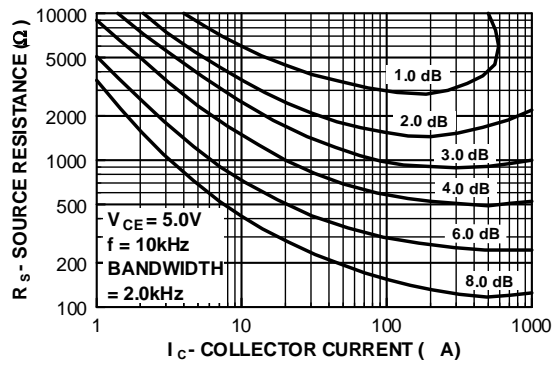

Figure 14. Contours of Constant Narrow Band Noise Figure

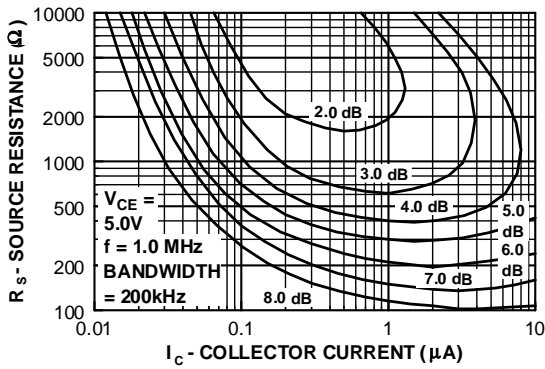

Figure 15. Contours of Constant Narrow Band Noise Figure

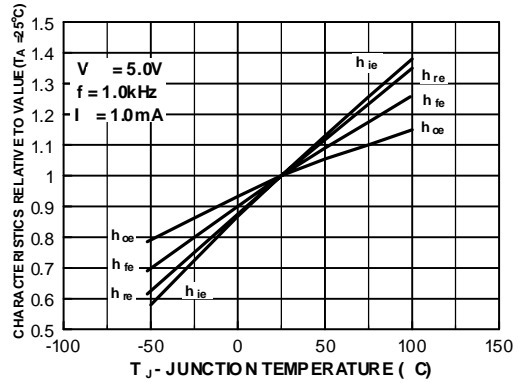

Figure 16. Typical Common Emitter Characteristics

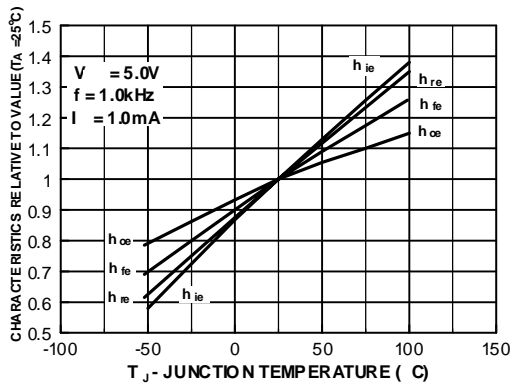

Figure 17. Typical Common Emitter Characteristics

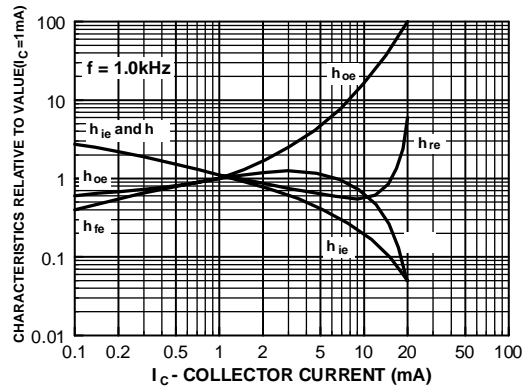
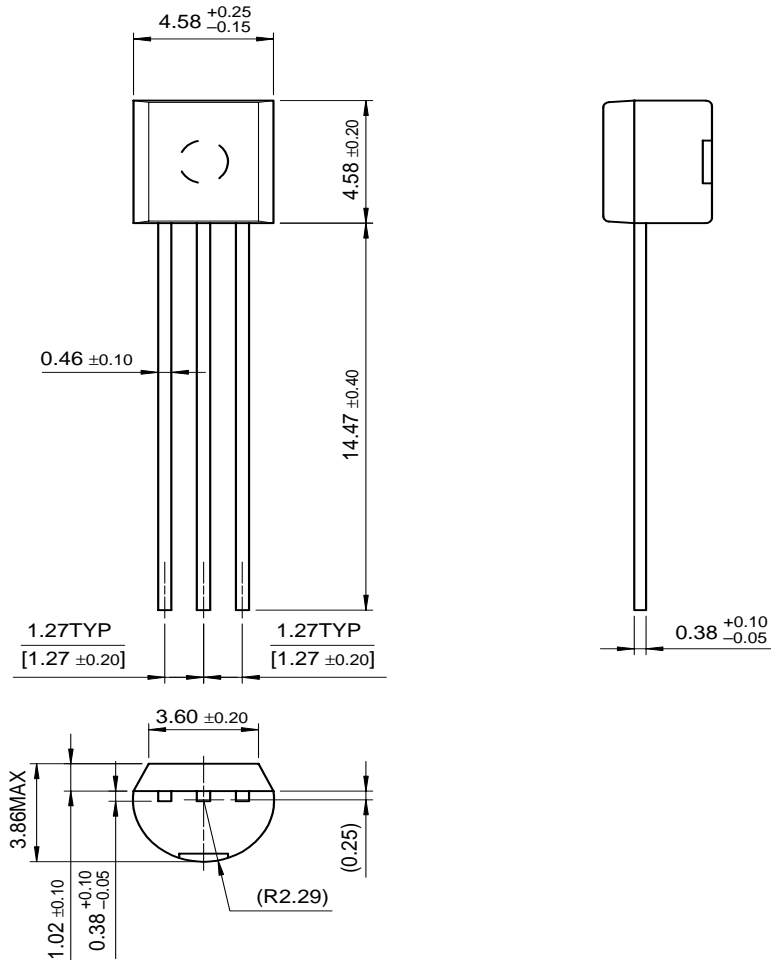

Figure 18. Typical Common Emitter Characteristics

Package Dimensions

TO-92



Dimensions in Millimeters

TRADEMARKS

The following are registered and unregistered trademarks Fairchild Semiconductor owns or is authorized to use and is not intended to be an exhaustive list of all such trademarks.

| | | | | |
|--|---------------------------------|--------------------------------|---------------------------------|-----------------------------|
| ACE [™] | FACT [™] | ImpliedDisconnect [™] | PACMAN [™] | SPM [™] |
| ActiveArray [™] | FACT Quiet series [™] | ISOPLANAR [™] | POP [™] | Stealth [™] |
| Bottomless [™] | FAST [®] | LittleFET [™] | Power247 [™] | SuperSOT [™] -3 |
| CoolFET [™] | FAST [™] | MicroFET [™] | PowerTrench [®] | SuperSOT [™] -6 |
| CROSSVOLT [™] | FRFET [™] | MicroPak [™] | QFET [™] | SuperSOT [™] -8 |
| DOME [™] | GlobalOptoisolator [™] | MICROWIRE [™] | QS [™] | SyncFET [™] |
| EcoSPARK [™] | GTO [™] | MSX [™] | QT Optoelectronics [™] | TinyLogic [™] |
| E ² CMOS [™] | HiSeC [™] | MSXPro [™] | Quiet Series [™] | TruTranslation [™] |
| EnSigna [™] | I ² C [™] | OCX [™] | RapidConfigure [™] | UHC [™] |
| Across the board. Around the world. [™] | | OCXPro [™] | RapidConnect [™] | UltraFET [®] |
| The Power Franchise [™] | | OPTOLOGIC [®] | SILENT SWITCHER [®] | VCX [™] |
| Programmable Active Droop [™] | | OPTOPLANAR [™] | SMART START [™] | |

DISCLAIMER

FAIRCHILD SEMICONDUCTOR RESERVES THE RIGHT TO MAKE CHANGES WITHOUT FURTHER NOTICE TO ANY PRODUCTS HEREIN TO IMPROVE RELIABILITY, FUNCTION OR DESIGN. FAIRCHILD DOES NOT ASSUME ANY LIABILITY ARISING OUT OF THE APPLICATION OR USE OF ANY PRODUCT OR CIRCUIT DESCRIBED HEREIN; NEITHER DOES IT CONVEY ANY LICENSE UNDER ITS PATENT RIGHTS, NOR THE RIGHTS OF OTHERS.

LIFE SUPPORT POLICY

FAIRCHILD'S PRODUCTS ARE NOT AUTHORIZED FOR USE AS CRITICAL COMPONENTS IN LIFE SUPPORT DEVICES OR SYSTEMS WITHOUT THE EXPRESS WRITTEN APPROVAL OF FAIRCHILD SEMICONDUCTOR CORPORATION.

As used herein:

1. Life support devices or systems are devices or systems which, (a) are intended for surgical implant into the body, or (b) support or sustain life, or (c) whose failure to perform when properly used in accordance with instructions for use provided in the labeling, can be reasonably expected to result in significant injury to the user.
2. A critical component is any component of a life support device or system whose failure to perform can be reasonably expected to cause the failure of the life support device or system, or to affect its safety or effectiveness.

PRODUCT STATUS DEFINITIONS

Definition of Terms

| Datasheet Identification | Product Status | Definition |
|--------------------------|------------------------|---|
| Advance Information | Formative or In Design | This datasheet contains the design specifications for product development. Specifications may change in any manner without notice. |
| Preliminary | First Production | This datasheet contains preliminary data, and supplementary data will be published at a later date. Fairchild Semiconductor reserves the right to make changes at any time without notice in order to improve design. |
| No Identification Needed | Full Production | This datasheet contains final specifications. Fairchild Semiconductor reserves the right to make changes at any time without notice in order to improve design. |
| Obsolete | Not In Production | This datasheet contains specifications on a product that has been discontinued by Fairchild semiconductor. The datasheet is printed for reference information only. |



LittleDiode supplies new, hard to find or obsolete electronic components and semiconductors all over the world.

With over two million different components listed you are sure to find the part you need.

Feel free to visit us today at our online store:

LittleDiode.com

Looking forward to providing you with the best possible service.