

Silicon NPN Planar RF Transistor

Electrostatic sensitive device.
Observe precautions for handling. 

Applications

RF amplifier up to GHz range specially for wide band antenna amplifier.

Features

- High power gain
- Low noise figure
- High transition frequency

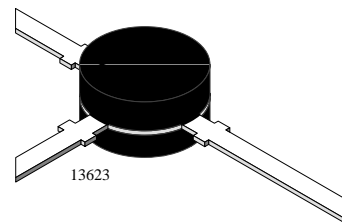
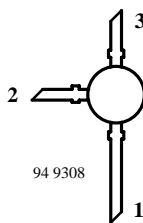

BFR96T Marking: BFR96T
Plastic case (TO 50)
1 = Collector, 2 = Emitter, 3 = Base

Absolute Maximum Ratings

$T_{amb} = 25^{\circ}\text{C}$, unless otherwise specified

Parameter	Test Conditions	Symbol	Value	Unit
Collector-base voltage		V_{CBO}	20	V
Collector-emitter voltage		V_{CEO}	15	V
Emitter-base voltage		V_{EBO}	2.5	V
Collector current		I_C	75	mA
Total power dissipation	$T_{amb} \leq 60^{\circ}\text{C}$	P_{tot}	500	mW
Junction temperature		T_j	175	$^{\circ}\text{C}$
Storage temperature range		T_{stg}	-65 to +150	$^{\circ}\text{C}$

Maximum Thermal Resistance

$T_{amb} = 25^{\circ}\text{C}$, unless otherwise specified

Parameter	Test Conditions	Symbol	Value	Unit
Junction ambient	on glass fibre printed board (40 x 25 x 1.5) mm ³ plated with 35 μm Cu	R_{thJA}	230	K/W

Electrical DC Characteristics

$T_{amb} = 25^{\circ}\text{C}$, unless otherwise specified

Parameter	Test Conditions	Symbol	Min	Typ	Max	Unit
Collector cut-off current	$V_{CE} = 20\text{ V}, V_{BE} = 0$	I_{CES}			100	μA
Collector-base cut-off current	$V_{CB} = 10\text{ V}, I_E = 0$	I_{CBO}			100	nA
Emitter-base cut-off current	$V_{EB} = 2.5\text{ V}, I_C = 0$	I_{EBO}			10	μA
Collector-emitter breakdown voltage	$I_C = 5\text{ mA}, I_B = 0$	$V_{(BR)CEO}$	15			V
DC forward current transfer ratio	$V_{CE} = 10\text{ V}, I_C = 50\text{ mA}$	h_{FE}	25	75	150	
	$V_{CE} = 10\text{ V}, I_C = 75\text{ mA}$	h_{FE}	25			

Electrical AC Characteristics

$T_{amb} = 25^{\circ}\text{C}$, unless otherwise specified

Parameter	Test Conditions	Symbol	Min	Typ	Max	Unit
Transition frequency	$V_{CE} = 10\text{ V}, I_C = 50\text{ mA}, f = 500\text{ MHz}$	f_T	4	5		GHz
Collector-base capacitance	$V_{CB} = 10\text{ V}, f = 1\text{ MHz}$	C_{cb}		0.85		pF
Collector-emitter capacitance	$V_{CE} = 10\text{ V}, f = 1\text{ MHz}$	C_{ce}		0.3		pF
Emitter-base capacitance	$V_{EB} = 0.5\text{ V}, f = 1\text{ MHz}$	C_{eb}		3.0		pF
Noise figure	$V_{CE} = 10\text{ V}, I_C = 50\text{ mA}, Z_S = 50\ \Omega,$ $f = 500\text{ MHz}$	F		3.3		dB
	$V_{CE} = 10\text{ V}, I_C = 50\text{ mA}, Z_S = 50\ \Omega,$ $f = 800\text{ MHz}$	F		3.8		dB
Power gain	$V_{CE} = 10\text{ V}, I_C = 50\text{ mA}, Z_S = 50\ \Omega,$ $Z_L = Z_{Lopt}, f = 500\text{ MHz}$	G_{pe}		16		dB
Linear output voltage – two tone intermodulation test	$V_{CE} = 10\text{ V}, I_C = 50\text{ mA}, d_{IM} = 60\text{ dB},$ $f_1 = 806\text{ MHz}, f_2 = 810\text{ MHz},$ $Z_S = Z_L = 50\ \Omega$	$V_1 = V_2$		400		mV
Third order intercept point	$V_{CE} = 10\text{ V}, I_C = 50\text{ mA}, f = 800\text{ MHz}$	IP_3		34		dBm



Common Emitter S-Parameters

$Z_0 = 50 \Omega$, $T_{amb} = 25^\circ C$, unless otherwise specified

V_{CE}/V	I_C/mA	f/MHz	S11		S21		S12		S22	
			LIN MAG	ANG	LIN MAG	ANG	LIN MAG	ANG	LIN MAG	ANG
				deg		deg		deg		deg
5	5	100	0.730	-69.4	12.04	139.0	0.046	58.6	0.812	-29.26
		300	0.629	-136.2	6.26	102.7	0.073	41.3	0.506	-46.8
		500	0.605	-162.0	3.98	86.6	0.084	42.5	0.425	-52.8
		800	0.588	176.3	2.55	70.9	0.102	49.1	0.403	-62.6
		1000	0.572	166.4	2.05	62.8	0.117	53.4	0.411	-69.8
		1200	0.565	157.4	1.73	55.8	0.135	56.4	0.425	-77.2
		1500	0.548	145.6	1.39	46.7	0.167	59.2	0.454	-88.2
		1800	0.532	134.3	1.18	38.4	0.202	59.9	0.489	-98.7
	2000	0.512	128.1	1.07	33.9	0.222	59.6	0.510	-105.6	
	10	100	0.592	-94.1	17.80	128.5	0.036	54.8	0.677	-41.8
		300	0.554	-153.1	7.77	96.7	0.057	50.7	0.361	-58.7
		500	0.544	-172.9	4.79	83.7	0.076	56.0	0.296	-64.5
		800	0.541	170.1	3.04	70.3	0.107	60.8	0.285	-74.3
		1000	0.529	161.3	2.44	63.4	0.129	62.1	0.294	-81.4
		1200	0.520	153.8	2.06	57.1	0.153	62.3	0.308	-88.3
		1500	0.505	143.3	1.66	48.6	0.190	61.2	0.336	-98.0
		1800	0.493	133.1	1.41	40.8	0.226	59.3	0.367	-107.2
	2000	0.475	127.1	1.28	36.1	0.244	57.9	0.387	-112.9	
	20	100	0.494	-121.1	22.50	119.1	0.027	56.4	0.538	-54.3
		300	0.510	-166.2	8.77	92.6	0.050	62.3	0.260	-71.9
		500	0.510	179.3	5.32	81.7	0.075	66.2	0.215	-79.1
		800	0.511	165.9	3.37	69.9	0.113	67.2	0.214	-89.7
		1000	0.502	158.5	2.71	63.7	0.139	66.6	0.226	-96.4
		1200	0.496	151.3	2.28	57.6	0.166	65.1	0.242	-102.4
		1500	0.479	141.6	1.85	49.8	0.205	62.2	0.269	-110.8
		1800	0.470	131.7	1.56	42.5	0.242	58.9	0.297	-118.2
	2000	0.458	126.3	1.42	37.6	0.259	56.8	0.315	-122.8	
	30	100	0.466	-135.8	24.37	114.8	0.023	59.1	0.468	-61.1
		300	0.498	-171.8	9.13	91.0	0.049	67.3	0.222	-80.1
		500	0.499	176.3	5.55	80.8	0.075	70.3	0.186	-88.4
		800	0.497	164.1	3.48	69.7	0.116	69.5	0.191	-99.1
		1000	0.494	157.0	2.81	63.7	0.144	68.1	0.205	-105.3
		1200	0.486	150.3	2.36	57.8	0.170	65.9	0.221	-110.7
		1500	0.473	140.9	1.92	50.0	0.210	62.6	0.247	-118.0
		1800	0.461	131.1	1.62	42.8	0.247	58.9	0.274	-124.3
	2000	0.447	126.0	1.47	38.2	0.266	56.5	0.291	-128.5	

V _{CE} /V	I _C /mA	f/MHz	S11		S21		S12		S22	
			LIN MAG	ANG	LIN MAG	ANG	LIN MAG	ANG	LIN MAG	ANG
				deg		deg		deg		deg
5	40	100	0.456	-144.1	25.30	112.3	0.021	62.7	0.426	-65.4
		300	0.493	-174.8	9.30	90.0	0.048	70.6	0.201	-85.7
		500	0.495	174.7	5.62	80.2	0.076	72.1	0.172	-94.8
		800	0.494	163.0	3.54	69.5	0.118	70.5	0.181	-105.1
		1000	0.491	156.3	2.84	63.5	0.146	68.7	0.195	-110.7
		1200	0.485	149.4	2.40	57.7	0.173	66.4	0.212	-115.8
		1500	0.469	140.9	1.94	50.0	0.213	62.5	0.238	-122.5
		1800	0.459	131.1	1.64	42.9	0.251	58.8	0.264	-128.1
	2000	0.448	126.1	1.49	38.1	0.269	56.4	0.281	-132.0	
	50	100	0.454	-150.0	25.82	110.6	0.021	63.6	0.398	-68.4
		300	0.491	-176.4	9.37	89.4	0.048	72.3	0.189	-89.5
		500	0.494	173.6	5.66	79.9	0.077	73.2	0.164	-99.0
		800	0.492	162.4	3.56	69.2	0.119	71.2	0.175	-108.9
		1000	0.488	155.6	2.86	63.4	0.147	69.1	0.190	-114.4
		1200	0.482	149.2	2.41	57.6	0.174	66.7	0.207	-119.0
		1500	0.471	140.7	1.96	50.0	0.215	62.7	0.233	-125.1
		1800	0.461	130.7	1.65	42.8	0.253	58.8	0.258	-130.5
	2000	0.449	125.4	1.49	38.2	0.271	56.2	0.274	-134.2	
	70	100	0.459	-156.8	26.13	108.5	0.019	66.9	0.360	-72.3
		300	0.492	-178.9	9.34	88.5	0.048	74.6	0.174	-94.5
		500	0.493	172.1	5.64	79.4	0.077	74.6	0.155	-104.3
		800	0.497	161.6	3.54	68.7	0.120	71.8	0.169	-113.5
		1000	0.494	155.2	2.85	62.8	0.149	69.5	0.185	-118.5
		1200	0.489	148.8	2.40	57.2	0.176	67.0	0.202	-122.6
1500		0.472	140.1	1.94	49.7	0.217	62.8	0.228	-128.3	
1800		0.464	130.5	1.64	42.5	0.255	58.8	0.254	-133.3	
2000	0.451	125.6	1.48	38.0	0.273	56.3	0.270	-136.6		



V _{CE} /V	I _C /mA	f/MHz	S11		S21		S12		S22	
			LIN MAG	ANG	LIN MAG	ANG	LIN MAG	ANG	LIN MAG	ANG
				deg		deg		deg		deg
10	5	100	0.743	-65.5	12.28	140.5	0.041	59.8	0.830	-26.3
		300	0.623	-132.2	6.55	104.2	0.068	42.7	0.540	-42.3
		500	0.592	-159.2	4.19	87.9	0.079	43.9	0.458	-47.4
		800	0.574	178.5	2.70	72.1	0.096	50.3	0.436	-56.4
		1000	0.561	167.5	2.17	64.1	0.111	54.8	0.440	-63.4
		1200	0.551	159.1	1.83	57.2	0.128	57.7	0.453	-70.4
		1500	0.533	147.2	1.47	48.0	0.158	60.7	0.480	-81.2
		1800	0.517	135.4	1.24	39.7	0.192	61.6	0.513	-91.6
		2000	0.502	128.9	1.13	35.1	0.211	61.5	0.534	-98.3
	10	100	0.603	-87.6	18.43	130.2	0.033	56.5	0.701	-37.5
		300	0.536	-149.1	8.23	97.9	0.054	51.6	0.392	-51.8
		500	0.524	-170.0	5.10	84.8	0.072	56.8	0.326	-56.3
		800	0.517	172.3	3.24	71.5	0.101	61.5	0.312	-65.2
		1000	0.506	163.4	2.60	64.5	0.123	63.0	0.319	-72.1
		1200	0.499	155.3	2.19	58.1	0.145	63.2	0.332	-78.9
		1500	0.486	144.9	1.77	49.7	0.180	62.3	0.356	-88.9
		1800	0.478	134.3	1.49	41.9	0.215	60.6	0.386	-98.2
		2000	0.462	128.8	1.36	37.4	0.234	59.3	0.406	-104.1
	20	100	0.492	-113.0	23.61	120.8	0.026	57.0	0.561	-48.5
		300	0.485	-162.2	9.35	93.7	0.048	62.0	0.284	-61.5
		500	0.482	-178.0	5.71	82.7	0.071	66.2	0.237	-66.6
		800	0.481	168.0	3.60	70.9	0.108	67.5	0.233	-76.4
		1000	0.475	160.0	2.89	64.7	0.133	67.1	0.242	-83.4
		1200	0.470	153.1	2.44	58.8	0.158	65.8	0.256	-89.8
1500		0.456	143.7	1.97	50.8	0.195	63.0	0.281	-99.0	
1800		0.449	133.7	1.67	43.5	0.231	60.1	0.309	-107.0	
2000		0.432	128.5	1.51	38.8	0.249	57.9	0.326	-112.2	



V _{CE} /V	I _C /mA	f/MHz	S11		S21		S12		S22	
			LIN MAG	ANG	LIN MAG	ANG	LIN MAG	ANG	LIN MAG	ANG
				deg		deg		deg		deg
10	30	100	0.454	-126.2	25.82	116.2	0.023	59.1	0.486	-54.5
		300	0.468	-167.9	9.78	91.8	0.047	67.0	0.239	-67.1
		500	0.466	179.0	5.94	81.7	0.072	70.0	0.201	-73.0
		800	0.469	166.4	3.74	70.6	0.111	69.6	0.203	-83.3
		1000	0.463	159.0	3.01	64.5	0.136	68.4	0.214	-90.1
		1200	0.458	152.0	2.53	58.8	0.162	66.5	0.229	-96.4
		1500	0.444	143.0	2.05	51.1	0.201	63.2	0.254	-104.9
		1800	0.438	133.0	1.73	43.6	0.238	59.8	0.281	-112.3
	2000	0.423	127.9	1.57	39.3	0.255	57.5	0.298	-117.1	
	40	100	0.438	-134.3	26.90	113.5	0.021	61.3	0.441	-57.8
		300	0.460	-171.0	9.97	90.8	0.046	70.0	0.214	-70.6
		500	0.459	177.1	6.04	81.1	0.073	71.7	0.183	-77.0
		800	0.463	165.5	3.80	70.3	0.113	70.4	0.188	-87.5
		1000	0.455	158.0	3.05	64.4	0.139	68.9	0.201	-94.3
		1200	0.453	152.0	2.57	58.9	0.165	66.9	0.216	-100.3
		1500	0.439	142.9	2.08	51.0	0.204	63.3	0.241	-108.3
		1800	0.435	133.3	1.76	43.8	0.240	59.7	0.268	-115.3
	2000	0.423	127.6	1.59	39.1	0.258	57.3	0.285	-119.7	
	50	100	0.431	-140.0	27.51	111.5	0.020	62.5	0.410	-60.4
		300	0.454	-172.7	10.04	90.0	0.046	71.5	0.198	-72.8
		500	0.456	176.4	6.08	80.7	0.073	72.7	0.171	-79.5
		800	0.460	164.9	3.81	70.0	0.114	71.0	0.179	-90.1
		1000	0.456	158.2	3.06	64.2	0.140	69.2	0.193	-96.7
		1200	0.453	151.5	2.59	58.5	0.167	67.0	0.209	-102.5
1500		0.443	142.6	2.09	51.1	0.205	63.3	0.234	-110.3	
1800		0.437	132.9	1.76	43.8	0.242	59.7	0.261	-116.9	
2000	0.423	128.1	1.60	39.4	0.259	57.2	0.278	-121.3		

Typical Characteristics ($T_{amb} = 25^{\circ}\text{C}$ unless otherwise specified)

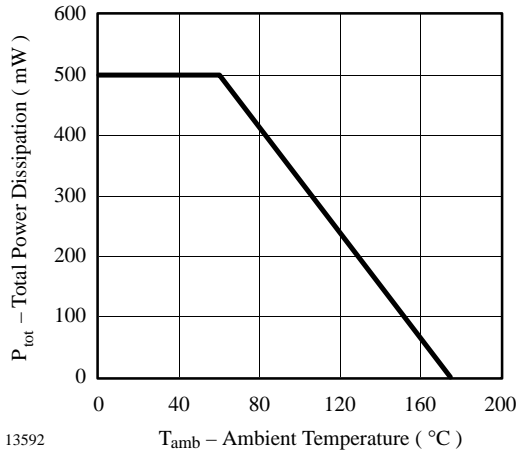

Figure 1. Total Power Dissipation vs. Ambient Temperature

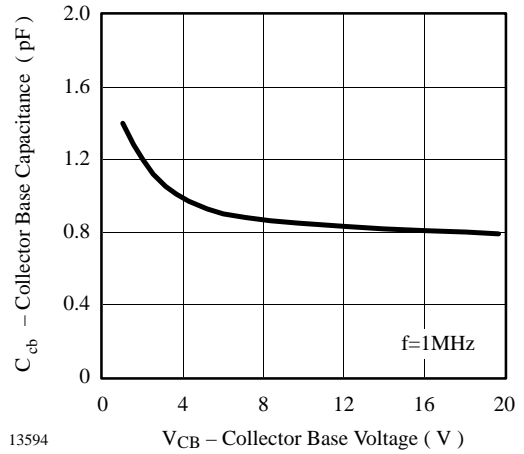

Figure 3. Collector Base Capacitance vs. Collector Base Voltage

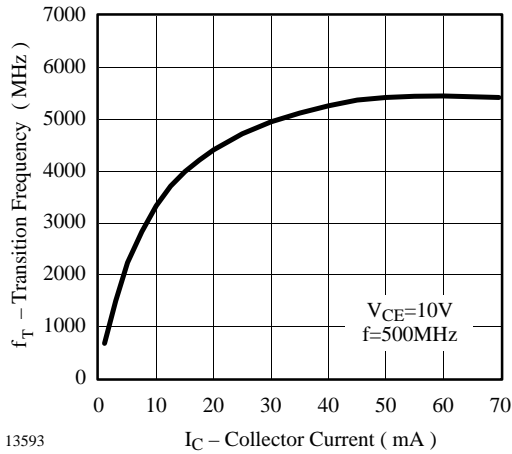

Figure 2. Transition Frequency vs. Collector Current

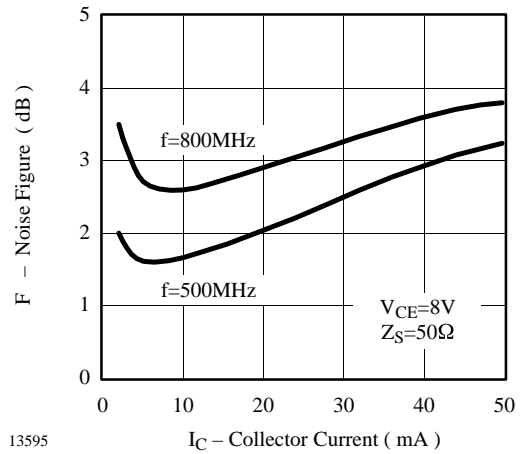

Figure 4. Noise Figure vs. Collector Current

$V_{CE} = 10 \text{ V}$, $I_C = 50 \text{ mA}$, $Z_0 = 50 \Omega$

S_{11}

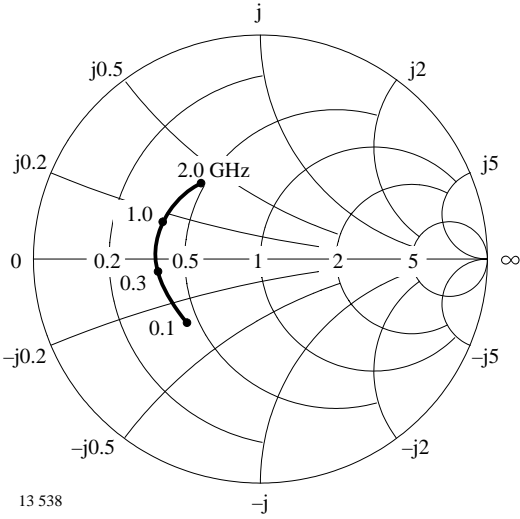

Figure 5. Input reflection coefficient

S_{12}

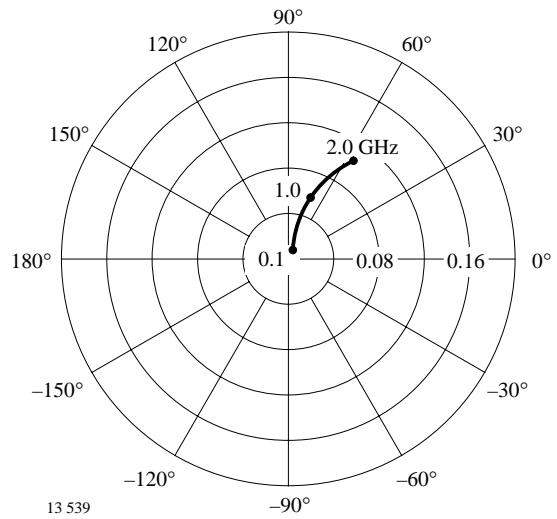

Figure 7. Reverse transmission coefficient

S_{21}

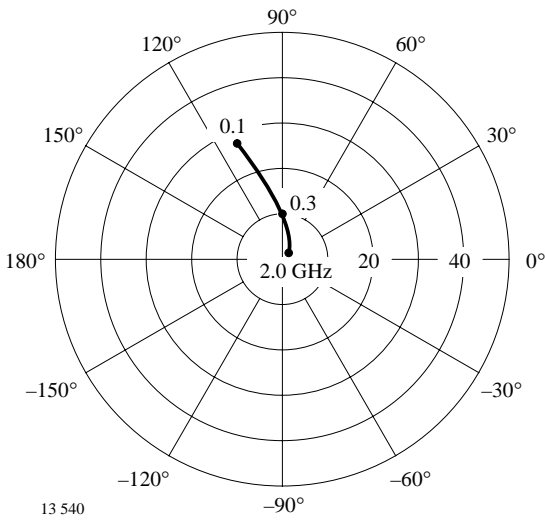

Figure 6. Forward transmission coefficient

S_{22}

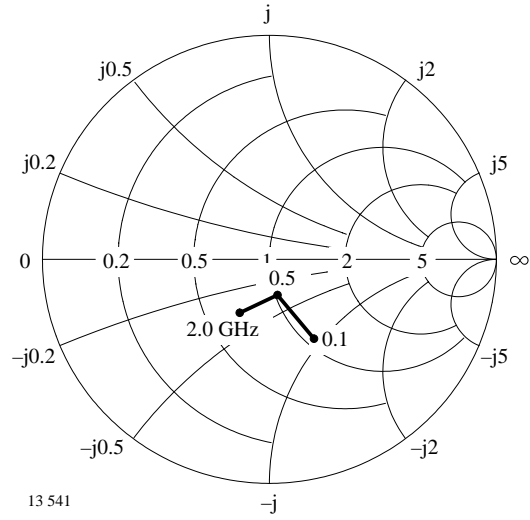
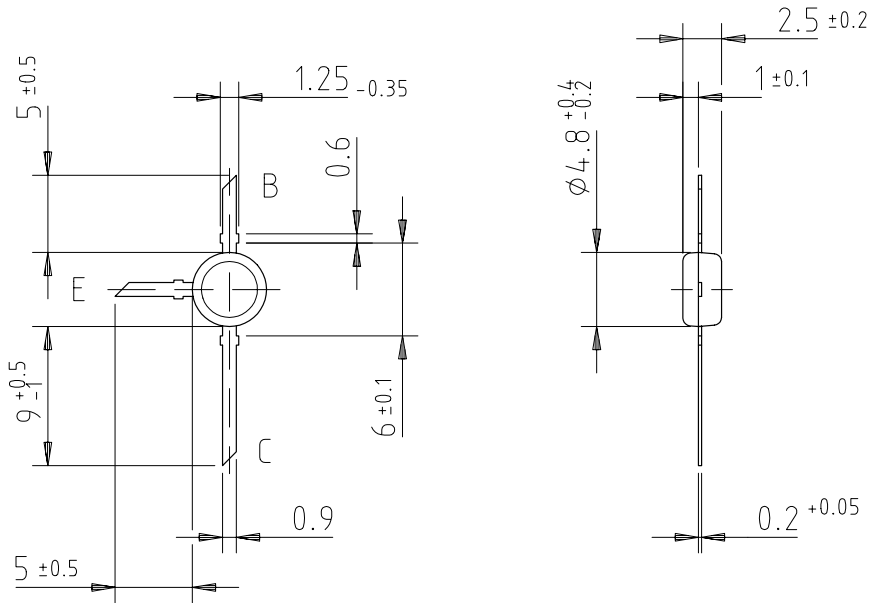
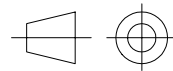

Figure 8. Output reflection coefficient

Dimensions of BFR96T in mm



96 12244



technical drawings
according to DIN
specifications

Ozone Depleting Substances Policy Statement

It is the policy of **Vishay Semiconductor GmbH** to

1. Meet all present and future national and international statutory requirements.
2. Regularly and continuously improve the performance of our products, processes, distribution and operating systems with respect to their impact on the health and safety of our employees and the public, as well as their impact on the environment.

It is particular concern to control or eliminate releases of those substances into the atmosphere which are known as ozone depleting substances (ODSs).

The Montreal Protocol (1987) and its London Amendments (1990) intend to severely restrict the use of ODSs and forbid their use within the next ten years. Various national and international initiatives are pressing for an earlier ban on these substances.

Vishay Semiconductor GmbH has been able to use its policy of continuous improvements to eliminate the use of ODSs listed in the following documents.

1. Annex A, B and list of transitional substances of the Montreal Protocol and the London Amendments respectively
2. Class I and II ozone depleting substances in the Clean Air Act Amendments of 1990 by the Environmental Protection Agency (EPA) in the USA
3. Council Decision 88/540/EEC and 91/690/EEC Annex A, B and C (transitional substances) respectively.

Vishay Semiconductor GmbH can certify that our semiconductors are not manufactured with ozone depleting substances and do not contain such substances.

We reserve the right to make changes to improve technical design and may do so without further notice.

Parameters can vary in different applications. All operating parameters must be validated for each customer application by the customer. Should the buyer use Vishay-Telefunken products for any unintended or unauthorized application, the buyer shall indemnify Vishay-Telefunken against all claims, costs, damages, and expenses, arising out of, directly or indirectly, any claim of personal damage, injury or death associated with such unintended or unauthorized use.

Vishay Semiconductor GmbH, P.O.B. 3535, D-74025 Heilbronn, Germany
Telephone: 49 (0)7131 67 2831, Fax number: 49 (0)7131 67 2423

This datasheet has been downloaded from:

www.DatasheetCatalog.com

Datasheets for electronic components.



LittleDiode supplies new, hard to find or obsolete electronic components and semiconductors all over the world.

With over two million different components listed you are sure to find the part you need.

Feel free to visit us today at our online store:

LittleDiode.com

Looking forward to providing you with the best possible service.