

# HD10551

## Prescaler for Digital Tuning System

### ■ FEATURES

- Six dividing ratios can be accomplished by supplying the DC potential to the certain pins: 1/10, 1/11, 1/20, 1/22, 1/40, 1/44
- High input sensitivity by on-chip pre amplifier: 40mVrms (typ.)
- On-chip ECL-CMOS level converter in the output stage
- A single source ( $V_{cc}=5.0\pm 0.5V$ )

### ■ BLOCK DIAGRAM AND EXAMPLE CIRCUIT

(FM OSC for Europe in division by 10)

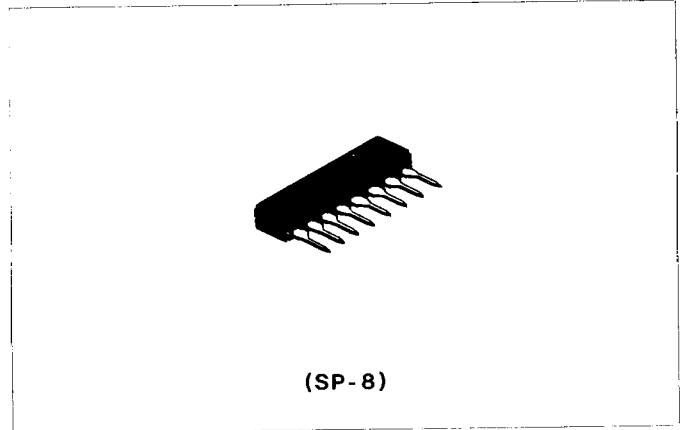
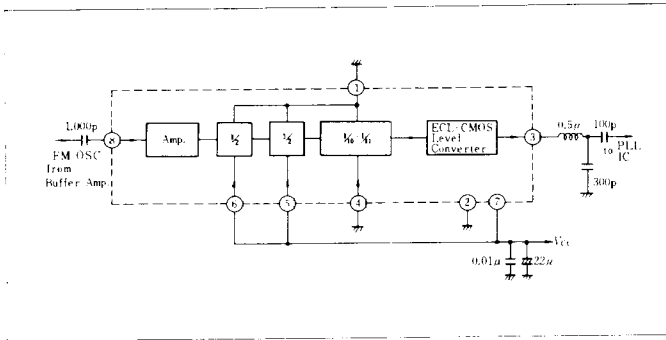

### ■ PIN ARRANGEMENT

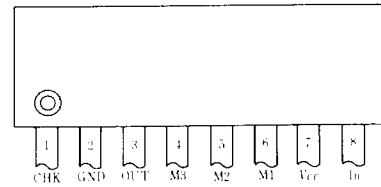

### ■ ABSOLUTE MAXIMUM RATINGS ( $T_a=25^\circ C$ )

Item	Symbol	Rating	Unit
Supply voltage	$V_{cc}$	8	V
Input voltage	$V_{in}$	8	V
Power Dissipation	$P_T$	350 ( $T_a=75^\circ C$ )	mW
Operating Temperature	$T_{op}$	-30 to +75	$^\circ C$
Storage Temperature	$T_{stg}$	-55 to +125	$^\circ C$

### ■ DIVIDING RATIOS

Dividing Ratio	Conditions			
	CHK 1-Pin	M1 6-Pin	M2 5-Pin	M3 4-Pin
1/10	GND	$V_{cc}$	$V_{cc}$	GND
1/11	GND	$V_{cc}$	$V_{cc}$	$V_{cc}$
1/20	GND	GND	$V_{cc}$	GND
1/22	GND	GND	$V_{cc}$	$V_{cc}$
1/40	GND	GND	GND	GND
1/44	GND	GND	GND	$V_{cc}$

### ■ ELECTRICAL CHARACTERISTICS ( $V_{cc}=5V$ , $T_a=25^\circ C$ )

Item	Symbol	Test Circuit	Test Conditions	Min.	Typ.	Max.	Unit
Recommended Operating Supply Voltage				4.5	5.0	5.5	V
Output Voltage	$V_{OH}$	2	Pin 3, $I_{OH} = -0.2mA$ , DC test	4.0	4.8	—	V
	$V_{OL}$	2	Pin 3, $I_{OL} = 1mA$ , DC test	—	0.8	1.0	V
Operating Current	$I_{cc}$		The mean value of high and low level output current	—	40	52	mA
Input Sensitivity		1	Pin 8 input, 150MHz sine wave, division by 10	—	40	140	mVrms
Input Response Frequency		1	Pin 8 input, 140mVrms sine wave, division by 10	150	250	—	MHz

Note) Pin 1 should be grounded.

■ TEST CIRCUIT

1.

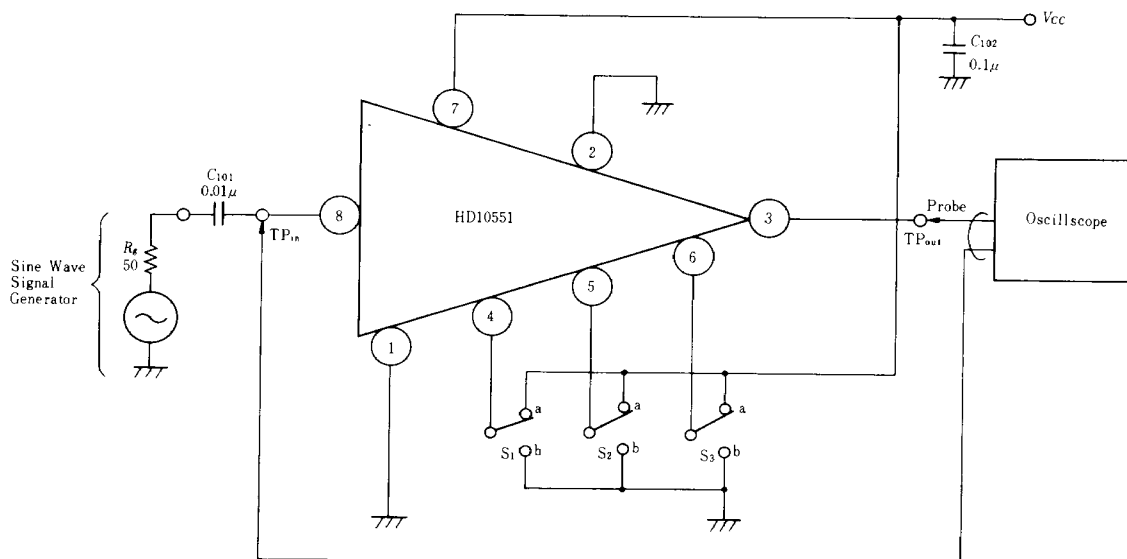

- Note) 1. Total load capacity connected to TPout should be less than 12.5pF.  
 2. Wire length between TPin and pin 8 and between TPout and pin 3 should be less than 6.25mm (1/4 inch).

2.

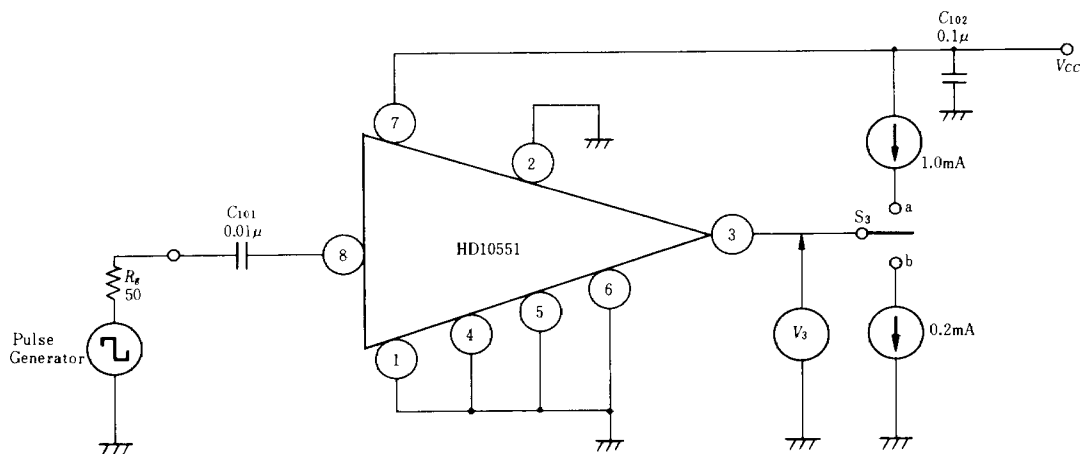

Note) Under high temperature and high voltage, output amplitude reduces on the high output frequency side. In the low input sensitivity system of the recipient side, therefore, set the

standard value of operating supply voltage lower within the range of recommended supply voltage, or use a power supply circuit having negative temperature characteristics.

OPERATING CURRENT vs. SUPPLY VOLTAGE

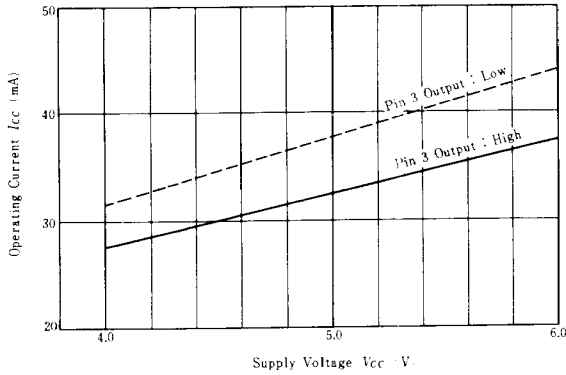

OUTPUT AMPLITUDE vs. OUTPUT LOAD CAPACITANCE

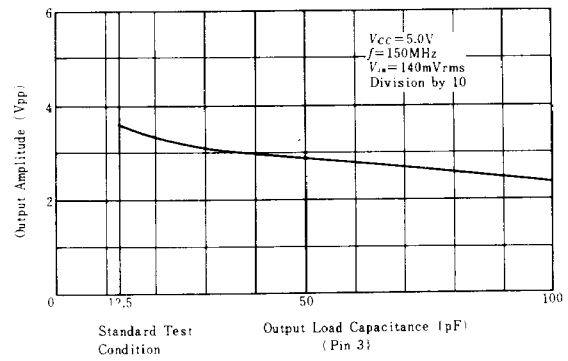

INPUT SENSITIVITY vs. INPUT FREQUENCY(1)

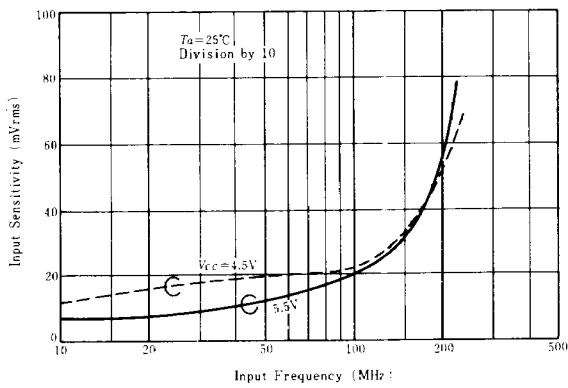

INPUT SENSITIVITY vs. INPUT FREQUENCY(2)

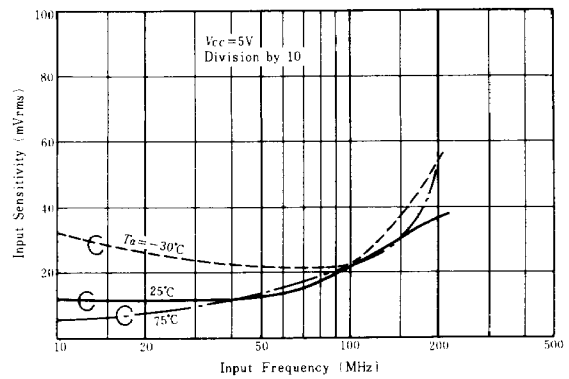

INPUT SENSITIVITY vs. AMBIENT TEMPERATURE

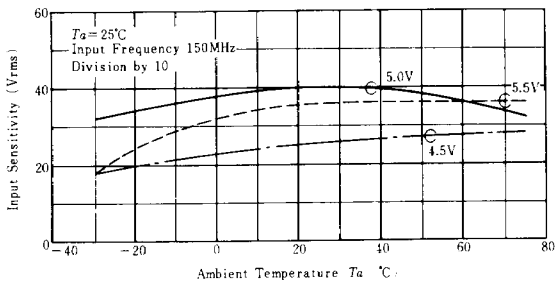

INPUT SENSITIVITY vs. SUPPLY VOLTAGE

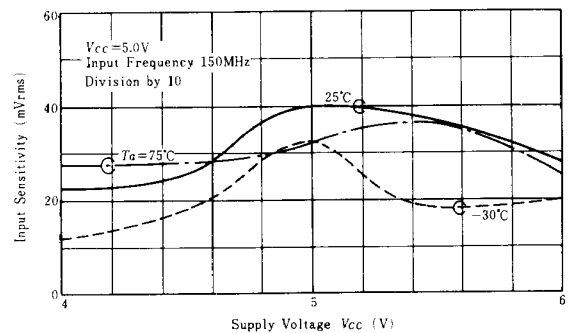

**OUTPUT AMPLITUDE vs.  
INPUT FREQUENCY(1)**

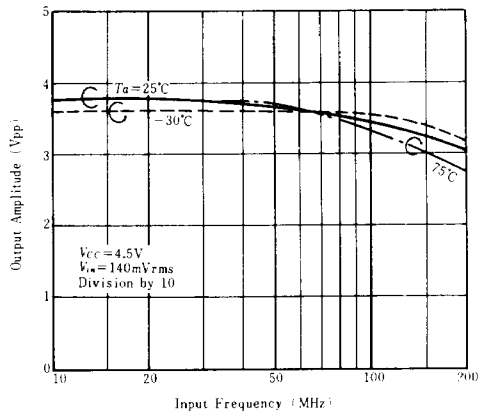

**OUTPUT AMPLITUDE vs.  
INPUT FREQUENCY(2)**

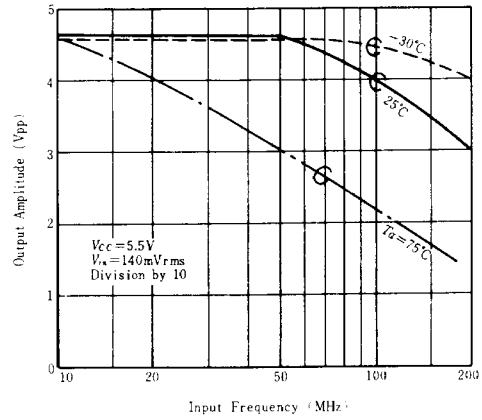

**OUTPUT AMPLITUDE vs.  
INPUT FREQUENCY(3)**

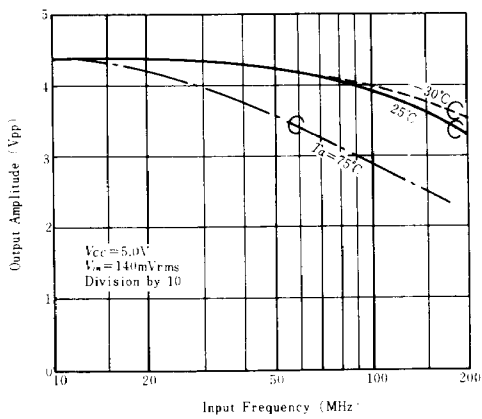

This datasheet has been downloaded from:

[www.DatasheetCatalog.com](http://www.DatasheetCatalog.com)

Datasheets for electronic components.



LittleDiode supplies new, hard to find or obsolete electronic components and semiconductors all over the world.

With over two million different components listed you are sure to find the part you need.

Feel free to visit us today at our online store:

[LittleDiode.com](http://LittleDiode.com)

Looking forward to providing you with the best possible service.