

FEATURES

Low Offset Voltage Drift
Matched Offset Voltage
Matched Offset Voltage Over Temperature
Matched Bias Currents
Crosstalk: -124 dB at 1 kHz
Low Bias Current: 35 pA max Warmed Up
Low Offset Voltage: 250 μ V max
Low Input Voltage Noise: 2 μ V p-p
High Open Loop Gain: 108 dB
Low Quiescent Current: 2.8 mA max
Low Total Harmonic Distortion
Standard Dual Amplifier Pinout
Available in Hermetic Metal Can Package, Hermetic Surface Mount (20-Pin LCC) and Chip Form
MIL-STD-883B Processing Also Available
Single Version Available: AD547

PRODUCT DESCRIPTION

The AD647 is an ultralow drift, dual JFET amplifier that combines high performance and convenience in a single package.

The AD647 uses the most advanced ion-implantation and laser wafer drift trimming technologies to achieve the highest performance currently available in a dual JFET. Ion-implantation permits the fabrication of matched JFETs on a monolithic bipolar chip. Laser wafer drift trimming trims both the initial offset voltage and its drift with temperature to provide offsets as low as 100 μ V (250 μ V max) and drifts of 2.5 μ V/ $^{\circ}$ C max.

In addition to outstanding individual amplifier performance, the AD647 offers guaranteed and tested matching performance on critical parameters such as offset voltage, offset voltage drift and bias currents.

The high level of performance makes the AD647 especially well suited for high precision instrumentation amplifier applications that previously would have required the costly selection and matching of space wasting single amplifiers.

The AD647 is offered in four performance grades, three commercial (the J, K and L) and one extended (the S). All are supplied in hermetically sealed 8-pin TO-99 packages and are available processed to MIL-STD-883B. The LCC version is also available processed to MIL-STD-883B.

REV. A

Information furnished by Analog Devices is believed to be accurate and reliable. However, no responsibility is assumed by Analog Devices for its use, nor for any infringements of patents or other rights of third parties which may result from its use. No license is granted by implication or otherwise under any patent or patent rights of Analog Devices.

PIN CONFIGURATION

TO-99 (H) Package

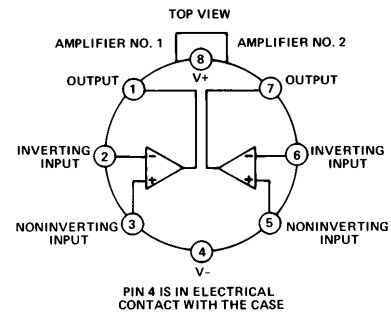

LCC (E) Package

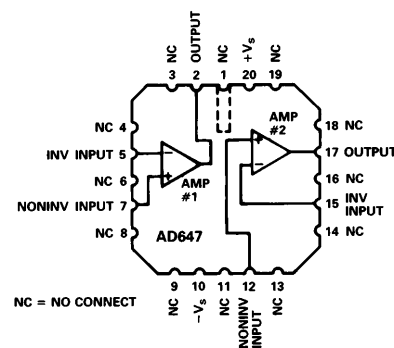

PRODUCT HIGHLIGHTS

1. The AD647 is guaranteed and tested to tight matching specifications to ensure high performance and to eliminate the selection and matching of single devices.
2. Laser wafer drift trimming reduces offset voltage and offset voltage drifts to 250 μ V and 2.5 μ V/ $^{\circ}$ C max.
3. Voltage noise is guaranteed at 4 μ V p-p max (0.1 Hz to 10 Hz) on K, L and S grades.
4. Bias current (35 pA K, L, S; 75 pA J) is specified after five minutes of operation.
5. Total supply current is a low 2.8 mA max.
6. High open loop gain ensures high linearity in precision instrumentation amplifier applications.
7. The standard dual amplifier pinout permits the direct substitution of the AD647 for lower performance devices.
8. The AD647 is available in chip form.

AD647—SPECIFICATIONS (@ +25°C and $V_S = \pm 15$ V dc)

| Model | AD647J | | | AD647K | | | AD647L | | | AD647S | | | Units |
|--|----------------------------|--------------|------------|----------------------------|--------------|------------|----------------------------|--------------|-------------|----------------------------|--------------|------------|------------------------|
| | Min | Typ | Max | Min | Typ | Max | Min | Typ | Max | Min | Typ | Max | |
| OPEN LOOP GAIN $V_O = \pm 10$ V, $R_L \geq 2$ k Ω T_{MIN} to T_{MAX} , $R_L = 2$ k Ω | 100,000 | | | 250,000 | | | 250,000 | | | 250,000 | | | V/V |
| OUTPUT CHARACTERISTICS | | | | | | | | | | | | | |
| Voltage @ $R_L = 2$ k Ω , T_{MIN} to T_{MAX} | ± 10 | ± 12 | | ± 10 | ± 12 | | ± 10 | ± 12 | | ± 10 | ± 12 | | V |
| Voltage @ $R_L = 10$ k Ω , T_{MIN} to T_{MAX} | ± 12 | ± 13 | | ± 12 | ± 13 | | ± 12 | ± 13 | | ± 12 | ± 13 | | V |
| Short Circuit Current | | 25 | | | 25 | | | 25 | | | 25 | | mA |
| FREQUENCY RESPONSE | | | | | | | | | | | | | |
| Unity Gain Small Signal | | 1.0 | | | 1.0 | | | 1.0 | | | 1.0 | | MHz |
| Full Power Response | | 50 | | | 50 | | | 50 | | | 50 | | kHz |
| Slew Rate, Unity Gain | 2.0 | 3.0 | | 2.0 | 3.0 | | 2.0 | 3.0 | | 2.0 | 3.0 | | V/ μ s |
| INPUT OFFSET VOLTAGE ¹ | | | | | | | | | | | | | |
| Initial Offset | | | 1.0 | | | 0.5 | | | 0.25 | | | 0.5 | mV |
| Input Offset Voltage vs. Temperature | | | 10 | | | 5 | | | 2.5 | | | 5.0 | μ V/ $^{\circ}$ C |
| Input Offset Voltage vs. Supply, T_{MIN} to T_{MAX} | | | 200 | | | 100 | | | 100 | | | 100 | μ V/V |
| INPUT BIAS CURRENT ² | | | | | | | | | | | | | |
| Either Input | | 10 | 75 | | 10 | 35 | | 10 | 35 | | 10 | 35 | pA |
| Offset Current | | 5 | | | 2 | | | 2 | | | 2 | | pA |
| MATCHING CHARACTERISTICS ³ | | | | | | | | | | | | | |
| Input Offset Voltage | | | 1.0 | | | 0.5 | | | 0.25 | | | 0.5 | mV |
| Input Offset Voltage T_{MIN} to T_{MAX} | | | 10 | | | 5 | | | 2.5 | | | 10.0 | μ V/ $^{\circ}$ C |
| Input Bias Current | | | 35 | | | 25 | | | 25 | | | 25 | pA |
| Crosstalk | | -124 | | | -124 | | | -124 | | | -124 | | dB |
| INPUT IMPEDANCE | | | | | | | | | | | | | |
| Differential | | $10^{12} 6$ | | | $10^{12} 6$ | | | $10^{12} 6$ | | | $10^{12} 6$ | | M Ω pF |
| Common Mode | | $10^{12} 6$ | | | $10^{12} 6$ | | | $10^{12} 6$ | | | $10^{12} 6$ | | M Ω pF |
| INPUT VOLTAGE RANGE | | | | | | | | | | | | | |
| Differential ⁴ | | ± 20 | | | ± 20 | | | ± 20 | | | ± 20 | | V |
| Common Mode | ± 10 | ± 12 | | ± 10 | ± 12 | | ± 10 | ± 12 | | ± 10 | ± 12 | | V |
| Common-Mode Rejection | | 76 | | | 80 | | | 80 | | | 80 | | dB |
| INPUT NOISE | | | | | | | | | | | | | |
| Voltage 0.1 Hz to 10 Hz | | 2 | | | 4 | | | 4 | | | 4 | | μ V p-p |
| $f = 10$ Hz | | 70 | | | 70 | | | 70 | | | 70 | | nV/ $\sqrt{\text{Hz}}$ |
| $f = 100$ Hz | | 45 | | | 45 | | | 45 | | | 45 | | nV/ $\sqrt{\text{Hz}}$ |
| $f = 1$ kHz | | 30 | | | 30 | | | 30 | | | 30 | | nV/ $\sqrt{\text{Hz}}$ |
| $f = 10$ kHz | | 25 | | | 25 | | | 25 | | | 25 | | nV/ $\sqrt{\text{Hz}}$ |
| POWER SUPPLY | | | | | | | | | | | | | |
| Rated Performance | | ± 15 | | | ± 15 | | | ± 15 | | | ± 15 | | V |
| Operating | ± 5 | | ± 18 | ± 5 | | ± 18 | ± 5 | | ± 18 | ± 5 | | ± 18 | V |
| Quiescent Current | | | 2.8 | | | 2.8 | | | 2.8 | | | 2.8 | mA |
| TEMPERATURE RANGE | | | | | | | | | | | | | |
| Operating, Rated Performance | 0 | | +70 | 0 | | +70 | 0 | | +70 | -55 | | +125 | $^{\circ}$ C |
| Storage | -65 | | +150 | -65 | | +150 | -65 | | +150 | -65 | | +150 | $^{\circ}$ C |
| PACKAGE OPTION | | | | | | | | | | | | | |
| TO-99 Style (H-08B) | | AD647JH | | | AD647KH | | | AD647LH | | | AD647SH | | |
| LCC (E-20A) | | | | | | | | | | | AD647SE | | AD647SE/883BH |

NOTES

¹Input Offset Voltage specifications are guaranteed after 5 minutes of operation at $T_A = +25^{\circ}$ C.

²Bias Current specifications are guaranteed at maximum at either input after 5 minutes of operation at $T_A = +25^{\circ}$ C. For higher temperatures, the current doubles every 10° C.

³Matching is defined as the difference between parameters of the two amplifiers.

⁴Defined as the maximum safe voltage between inputs, such that neither exceeds ± 10 V from ground.

Specifications shown in **boldface** are tested on all production units at final electrical test. Results from those tests are used to calculate outgoing quality levels. All min and max specifications are guaranteed, although only those shown in **boldface** are tested on all production units.

Specifications subject to change without notice.

METALIZATION PHOTOGRAPH

Dimensions shown in inches and (mm).

Contact factory for latest dimensions.

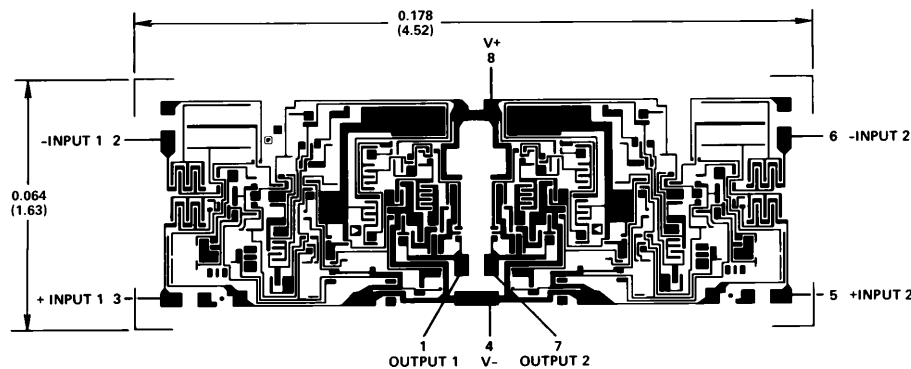

Typical Characteristics—AD647

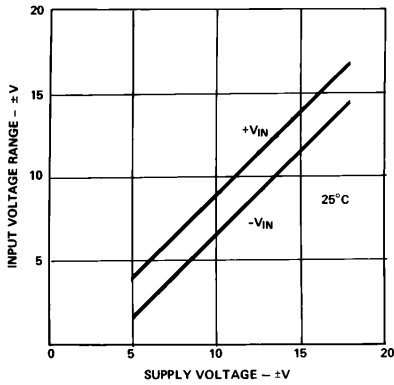

Figure 1. Input Voltage Range vs. Supply Voltage

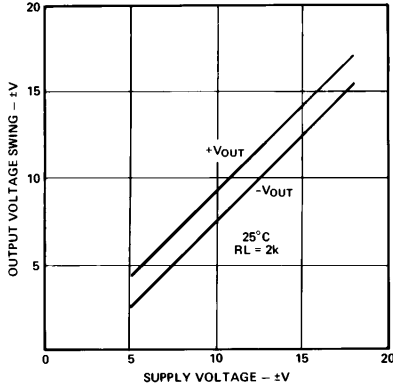

Figure 2. Output Voltage Swing vs. Supply Voltage

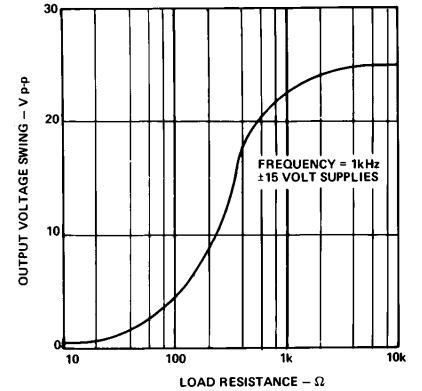

Figure 3. Output Voltage Swing vs. Load Resistance

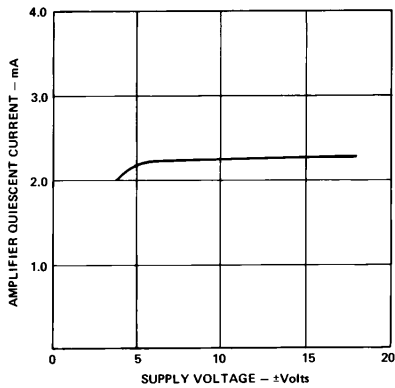

Figure 4. Quiescent Current vs. Supply Voltage

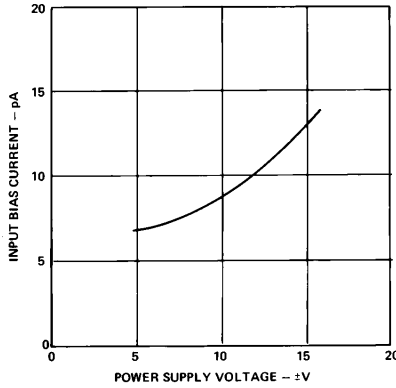

Figure 5. Input Bias Current vs. Power Supply Voltage

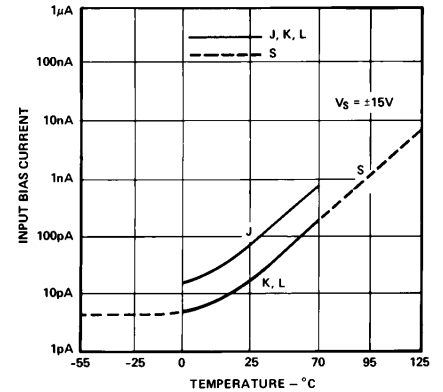

Figure 6. Input Bias Current vs. Temperature

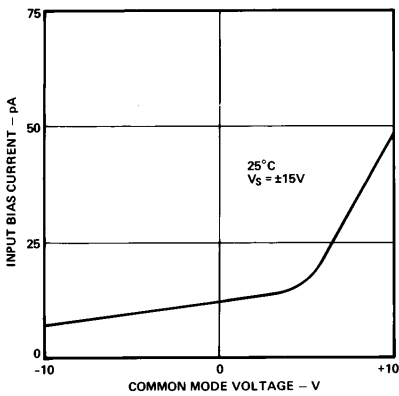

Figure 7. Input Bias Current vs. CMV

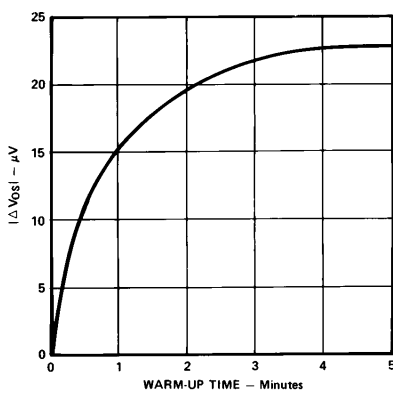

Figure 8. Change in Offset Voltage vs. Warm-Up Time

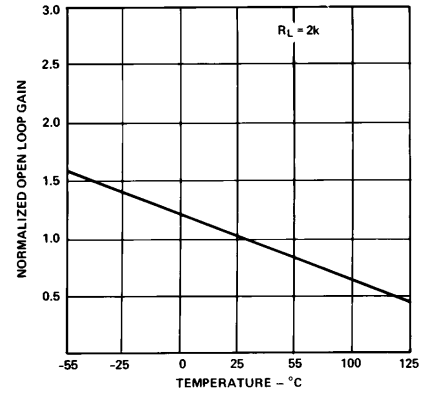

Figure 9. Open Loop Gain vs. Temperature

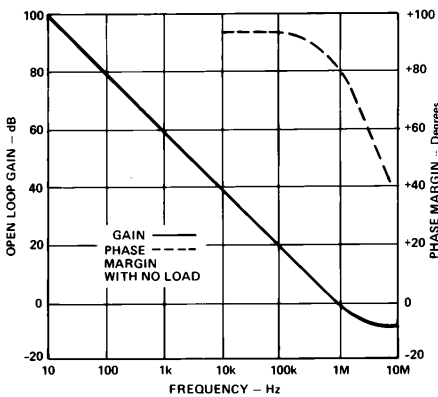

Figure 10. Open Loop Frequency Response

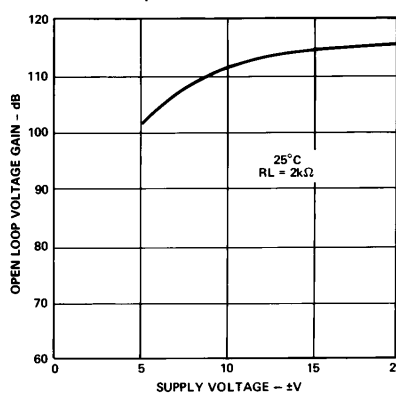

Figure 11. Open Loop Voltage Gain vs. Supply Voltage

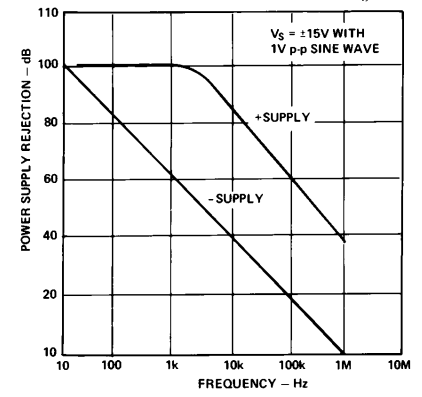

Figure 12. Power Supply Rejection vs. Frequency

AD647

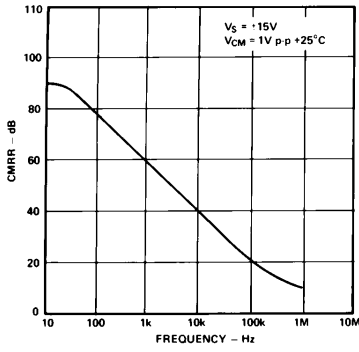

Figure 13. Common-Mode Rejection Ratio vs. Frequency

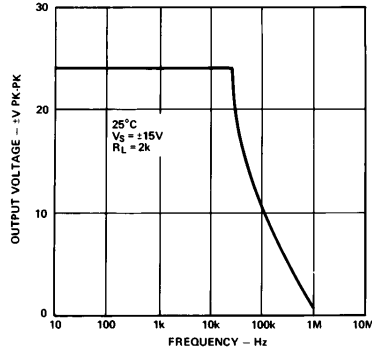

Figure 14. Large Signal Frequency Response

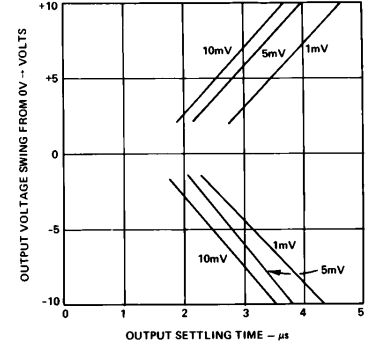

Figure 15. Output Settling Time vs. Output Swing and Error (Circuit of Figure 23)

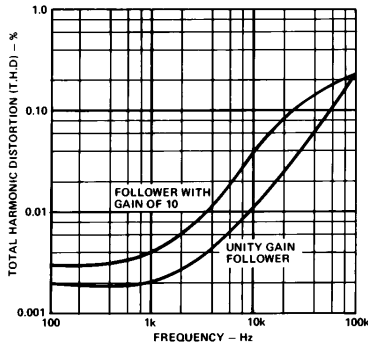

Figure 16. Total Harmonic Distortion vs. Frequency

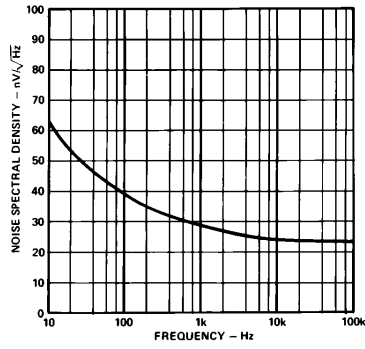

Figure 17. Input Noise Voltage Spectral Density

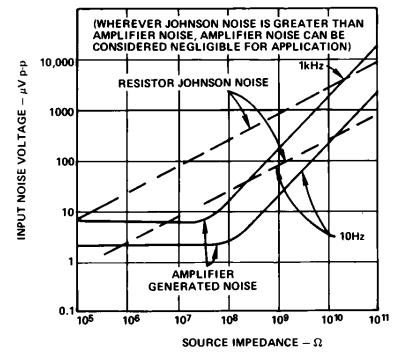
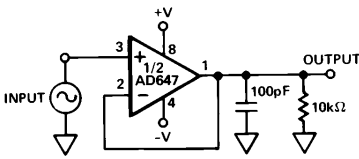
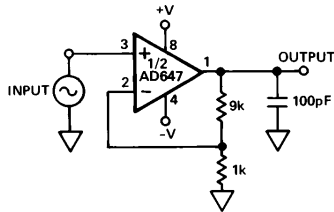

Figure 18. Total RMS Noise vs. Source Impedance



a. Unity Gain Follower



b. Follower with Gain = 10

Figure 19. T.H.D. Test Circuits

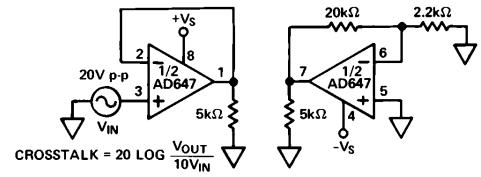

Figure 20. Crosstalk Test Circuit

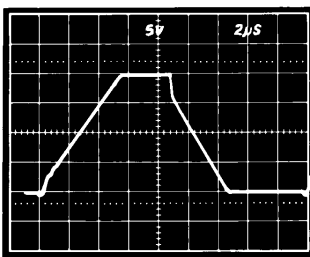

Figure 21a. Unity Gain Follower Pulse Response (Large Signal)

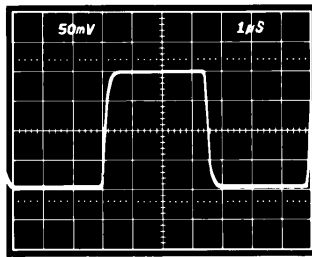

Figure 21b. Unity Gain Follower Pulse Response (Small Signal)

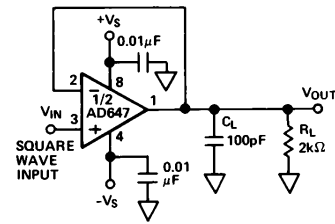

Figure 21c. Unity Gain Follower

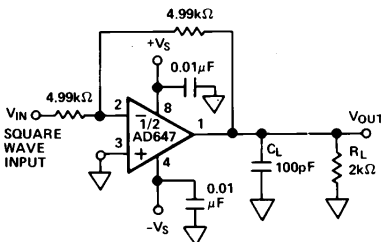

Figure 22a. Unity Gain Inverter

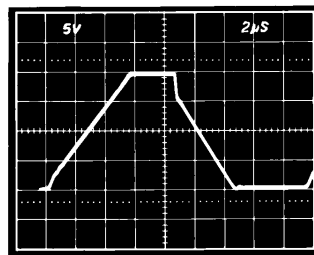

Figure 22b. Unity Gain Inverter Pulse Response (Large Signal)

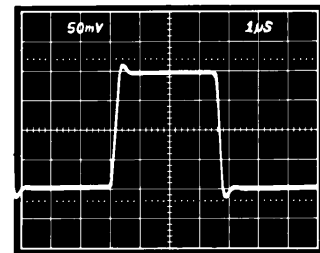

Figure 22c. Unity Gain Inverter Pulse Response (Small Signal)

APPLICATION NOTES

The AD647 is fully specified under actual operating conditions to insure high performance in any application, but there are some steps that will improve on even this high level of performance.

The bias current of a JFET amplifier doubles with every 10°C increase in junction temperature. Any heat source that can be eliminated or minimized will significantly improve bias current performance. To account for normal power dissipation, the largest contributor to chip self-heating, the bias currents of the AD647 are guaranteed fully warmed up with ±15 V supplies. A decrease in supply voltage will decrease power consumption, resulting in a corresponding drop in bias currents.

Open loop gain and bias currents, to some extent, are affected by output loading. In applications where high linearity is essential, load impedance should be kept as high as possible to minimize degradation of open loop gain.

The outstanding ac and dc performance of the AD647 make it an ideal choice for critical instrumentation applications. In such applications, leakage paths, line losses and external noise sources should be considered in the layout of printed circuit boards. A guard ring surrounding the inputs and connected to a low impedance potential (at the same level as the inputs) should be placed on both sides of the circuit board. This will eliminate leakage paths that could degrade bias current performance. All signal paths should be shielded to minimize noise pickup.

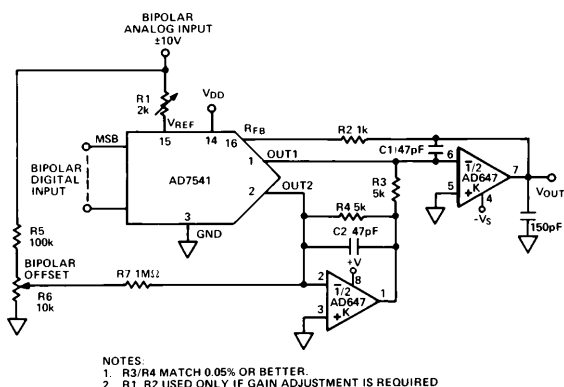

Figure 23. AD647 Used as DAC Output Amplifier

A CMOS DAC AMPLIFIER

The output impedance of a CMOS DAC, such as the AD7541, varies with digital input code. This causes a corresponding variation in the noise gain of the DAC-amplifier combination. This noise gain modulation introduces a nonlinearity whose magnitude is dependent on the amount of offset voltage present.

Laser wafer drift trimming lowers the initial offset voltage and the offset voltage drift of the AD647, therefore minimizing the effect of this nonlinearity and its drift with temperature. This, in conjunction with the low bias current and high open loop gain, makes the AD647 ideal for DAC output amplifier applications.

THE AD647 USED WITH THE AD7546

Figure 24 shows the AD647 used with the AD7546 16-bit segment DAC. In this application, amplifier performance is critical to the overall performance of the AD7546. A1 is used as a dual precision buffer. Here the offset voltage match, low offset voltage and high open loop gain of the AD647 ensure monotonicity and high linearity over the entire operating temperature range. A2 serves a dual function amplifier A is a Track and Hold circuit that deglitches the DAC output and amplifier B acts as an output amplifier. The performance of the amplifiers of A2 is crucial to the accuracy of the system. The errors of these amplifiers are added to the errors due strictly to DAC imperfections. For this reason great care should be used in the selection of these amplifiers. The matching characteristics, low bias current and low temperature coefficients of the AD647 make it ideal for this application.

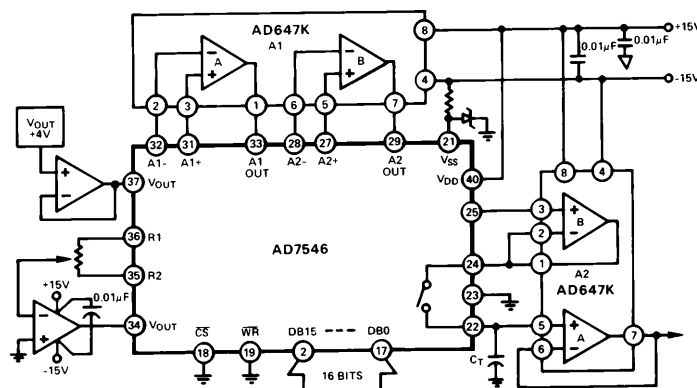

Figure 24. AD647 Used with AD7546 16-Bit DAC

USING THE AD647 IN LOG AMPLIFIER APPLICATIONS

Log amplifiers or log ratio amplifiers are useful in a wide range of analog computational applications, ranging from the simple linearization of exponential transducer outputs to the use of logarithms in computations involving multi-term products or arbitrary exponents. Log amps also facilitate the compression of wide ranging analog input signals into a range that can be easily handled using standard circuit techniques.

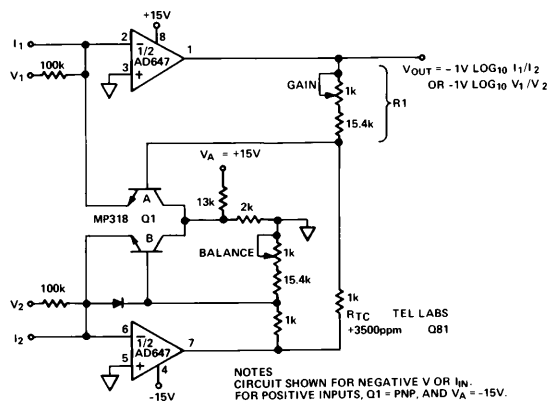

Figure 25. Log-Ratio Amplifier

AD647

The picoamp level input current and low offset voltage of the AD647 make it suitable for wide dynamic range log amplifiers. Figure 25 is a schematic of a log ratio circuit employing the AD647 that can achieve less than 1% conformance error over 5 decades of current input, 1 nA to 100 μA. For voltage inputs, the dynamic range is typically 50 mV to 10 V for 1% error, limited on the low end by the amplifiers' input offset voltage.

The conversion between current (or voltage) input and log output is accomplished by the base-emitter junctions of the dual transistor Q1. Assuming Q1 has $\beta > 100$, which is the case for the specified transistor, the base-emitter voltage on side 1 is to a close approximation

$$V_{BE A} = kT/q \ln I_1/I_{S1}$$

This circuit is arranged to take the difference of the V_{BE} s of Q1A and Q1B, thus producing an output voltage proportional to the log of the ratio of the inputs

$$V_{OUT} = -K (V_{BE A} - V_{BE B}) = \frac{KkT}{q} (\ln I_1/I_{S1} - \ln I_2/I_{S2})$$

$$V_{OUT} = -K kT/q \ln I_1/I_2$$

The scaling constant, K is set by R1 and R_{TC} to about 16, to produce a 1 V change in output voltage per decade difference in input signals. R_{TC} is a special resistor with a +3500 ppm/°C temperature coefficient, which makes K inversely proportional to temperature, compensating for the "T" in kT/q. The log ratio transfer characteristic is therefore independent of temperature.

This particular log ratio circuit is free from the dynamic problems that plague many other log circuits. The -3 dB bandwidth is 50 kHz over the top 3 decades, 100 nA to 100 μA, and decreases smoothly at lower input levels. This circuit needs no additional frequency compensation for stable operation from input current sources, such as photodiodes, which may have 100 pF of shunt capacitance. For larger input capacitances a 20 pF integration capacitor around each amplifier will provide a smoother frequency response.

This log ratio amplifier can be readily adjusted for optimum accuracy by following this simple procedure. First, apply $V_1 = V_2 = -10.00$ V and adjust "Balance" for $V_{OUT} = 0.00$ V. Next apply $V_1 = -10.00$ V, $V_2 = -100$ V and adjust gain for $V_{OUT} = +1.00$ V. Repeat this procedure until gain and balance readings are within 2 mV of ideal values.

ACTIVE FILTERS

In active low-pass filtering applications the dc accuracy of the amplifiers used is critical to the performance of the filter cir-

cuits. DC error sources such as offset voltage and bias currents represent the largest individual contributors to output error. Offset voltages will be passed by the filtering network and may, depending on the design of the filter circuit, be amplified and generate unacceptable output offset voltages. In filter circuits for low frequency ranges large value resistors are used to generate the low-pass filter function. Input bias currents passing through these resistors will generate an additional offset voltage that will also be passed to the output of the filter.

The use of the AD647 will minimize these error sources and, therefore, maximize filter accuracy. The wide variety of performance levels of the AD647 allows for just the amount of accuracy required for any given application.

AD647 AS AN INSTRUMENTATION AMPLIFIER

The circuit shown in Figure 26 uses the AD647 to construct an ultra high precision instrumentation amplifier. In this type of application the matching characteristics of a monolithic dual amplifier are crucial to ensure high performance.

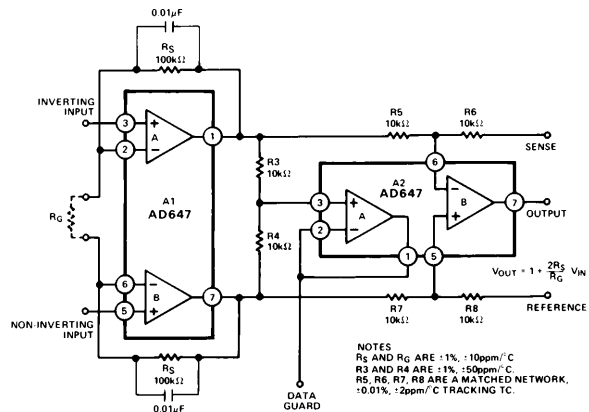

Figure 26. Precision FET Input Instrumentation Amplifier

The use of an AD647L as the input amplifier A1, guarantees maximum offset voltage of 250 μV, drift of 2.5 μV/°C and bias currents of 35 pA. A2 serves two less critical functions in the amplifier and, therefore can be an AD647J. Amplifier A is an active data guard which increases ac CMRR and minimizes extraneous signal pickup and leakage. Amplifier B is the output amplifier of the instrumentation amplifier. To attain the precision available from this configuration, a great deal of care should be taken when selecting the external components. CMRR will depend on the matching of resistors R1, R2, R3, and R4. The gain drift performance of this circuit will be affected by the matching TC of the resistors used.

OUTLINE DIMENSIONS

Dimensions shown in inches and (mm).

TO-99

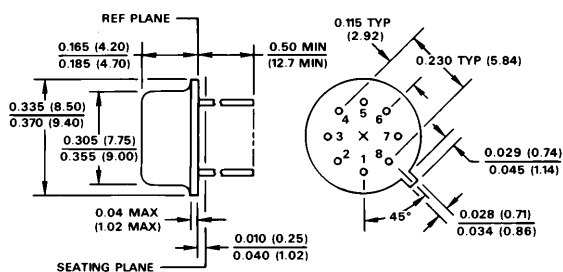

E-20A

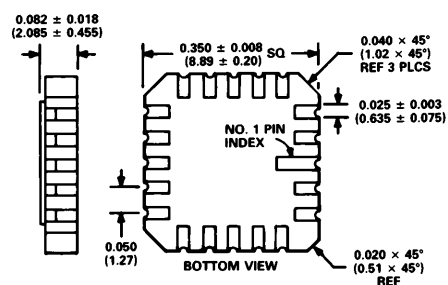



LittleDiode supplies new, hard to find or obsolete electronic components and semiconductors all over the world.

With over two million different components listed you are sure to find the part you need.

Feel free to visit us today at our online store:

LittleDiode.com

Looking forward to providing you with the best possible service.