

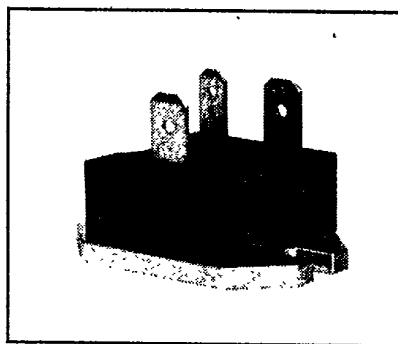

**D66DS**  
**D66ES**

Powerex, Inc., Hillis Street, Youngwood, Pennsylvania 15697 (412) 925-7272

**Fast Switching  
Single Darlington  
Transistor Module  
20 Amperes  
500-600-700 Volts**

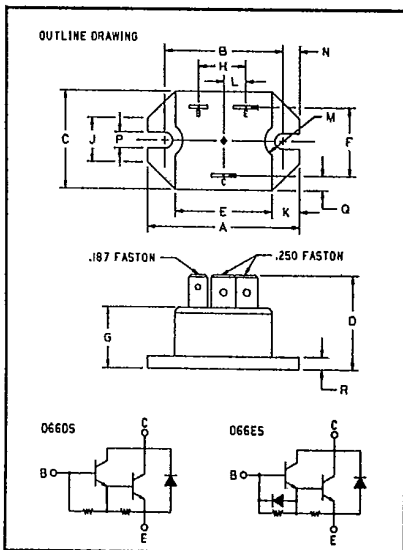

**D66DS**  
**D66ES**  
**Fast Switching Single Darlington  
Transistor Module**  
20 Amperes/500-600-700 Volts

**Description**

Powerex Fast Switching Single Darlington Transistor Modules are designed for use in switching applications. The modules are isolated consisting of one Darlington Transistor with a monolithic reverse parallel connected free-wheel diode.

**Features:**

- Isolated Mounting
- High Gain ( $h_{FE}$ )
- Quick Connect Terminals
- Base Emitter Speed-up Diode (D66ES)

**Applications:**

- UPS Inverters
- DC Motor Control
- Switching Power Supplies
- AC Motor Control

**Ordering Information**

Example: Select the complete six digit module part number you desire from the table - i.e. D66DS7 is a 700 Volt, 20 Ampere Fast Switching Single Darlington Module without speed-up diode. D66ES7 is a 700 Volt, 20 Ampere Fast Switching Darlington Module with speed-up diode.

**500-600-700 Volts D66DS, D66ES  
Outline Drawing**

Dimension	Inches	Millimeters
A	1.52	38.6
B	1.186 ± .006	30 ± 0.15
C	1000 ± .015	25.4 ± 0.4
D	.97	24.6
E	.96	24.4
F	.694 ± .010	17.6 ± 0.25
G	.625 ± .020	15.9 ± 0.5
H	.474 ± .010	12 ± 0.25
J	.450	11.4
K	.275	7
L	.220 ± .010	5.6 ± 0.25
M	.180 R	4.6 R
N	.167 ± .010	4.2 ± 0.25
P	.160 ± .010	4.1 ± 0.25
Q	.15	3.8
R	.126 ± .006	3.2 ± 0.15

Type	V <sub>CEV(SUS)</sub> Volts (×100)	Current Rating Amperes (20)
D66DS/D66ES	5	20
D66DS/D66ES	6	20
D66DS/D66ES	7	20



Powerex, Inc., Hillis Street, Youngwood, Pennsylvania 15697 (412) 925-7272

**D66DS**

**D66ES**

**Fast Switching Single Darlington Transistor Module**  
20 Amperes/500-600-700 Volts

**Maximum Ratings  $T_J = 25^\circ\text{C}$  unless otherwise specified**

	Symbol	D66DS/D66ES	Units
Junction Temperature	$T_J$	-40 to 150	$^\circ\text{C}$
Storage Temperature	$T_{STG}$	-40 to 150	$^\circ\text{C}$
Collector-Emitter Sustaining Voltage D66DS5/ES5	$V_{CEO(SUS)}$	400	Volts
Collector-Emitter Voltage $V_{BE} = -1.5\text{V}$ D66DS5/ES5	$V_{CEV}$	500	Volts
Collector-Emitter Sustaining Voltage D66DS6/ES6	$V_{CEO(SUS)}$	450	Volts
Collector-Emitter Voltage $V_{BE} = -1.5\text{V}$ D66DS6/ES6	$V_{CEV}$	600	Volts
Collector-Emitter Sustaining Voltage D66DS7/ES7	$V_{CEO(SUS)}$	500	Volts
Collector-Emitter Voltage $V_{BE} = -1.5\text{V}$ D66DS7/ES7	$V_{CEV}$	700	Volts
Emitter-Base Voltage D66DS	$V_{EBO}$	8	Volts
D66ES	$V_{EBO}$	5	Volts
Continuous Collector Current	$I_C$	20	Amperes
Peak (Repetitive) Collector Current	$I_{CM}$	30	Amperes
Peak (Non-Repetitive) Collector Current	$I_{CSM}$	50	Amperes
Diode Forward Current	$I_{FM}$	20	Amperes
Continuous Base Current	$I_B$	5	Amperes
Peak (Non-Repetitive) Base Current	$I_{BM}$	10	Amperes
Power Dissipation	$P_T$	62.5	Watts
Max. Mounting Torque (M3) Mounting Screws	—	8	in.-lb.
V Isolation	$V_{RMS}$	2500	Volts



Powerex, Inc., Hillis Street, Youngwood, Pennsylvania 15697 (412) 925-7272

D66DS  
D66ES

Fast Switching Single Darlington Transistor Module  
20 Amperes/500-600-700 Volts

**Electrical and Mechanical Characteristics  $T_J = 25^\circ\text{C}$  unless otherwise specified**

Characteristics	Symbol	Test Conditions	D66DS, D66ES			Units
			Min.	Typ.	Max.	
Collector Cutoff Current	$I_{CEV}$	$V_{CE} = V_{CEV}(\text{rated}), V_{BE} = -1.5\text{V}$	—	—	1	mA
Collector Cutoff Current	$I_{CEV}$	$V_{CE} = V_{CEV}(\text{rated}), V_{BE} = -1.5\text{V}$ $T_C = 150^\circ\text{C}$	—	—	2.5	mA
Emitter Cutoff Current	$I_{EBO}$	$V_{EB} = 4.5\text{V}, \text{D66DS}$	—	—	200	mA
		$V_{EB} = 1.5\text{V}, \text{D66ES}$	—	—	200	mA
DC Current Gain	$h_{FE}$	$I_C = 30\text{A}, V_{CE} = 5.0\text{V}$	20	35	—	—
		$I_C = 20\text{A}, V_{CE} = 5.0\text{V}$	40	85	—	—
		$I_C = 10\text{A}, V_{CE} = 5.0\text{V}$	100	160	—	—
Collector-Emitter Saturation Voltage	$V_{CE(\text{SAT})}$	$I_C = 30\text{A}, I_B = 3.0\text{A}$	—	2.1	3.5	V
		$I_C = 20\text{A}, I_B = 2.0\text{A}$	—	1.6	2.5	V
		$I_C = 10\text{A}, I_B = 1.0\text{A}$	—	1.2	1.7	V
Base-Emitter Saturation Voltage	$V_{BE(\text{SAT})}$	$I_C = 30\text{A}, I_B = 3.0\text{A}$	—	2.65	4.0	V
		$I_C = 20\text{A}, I_B = 2.0\text{A}$	—	2.3	3.0	V
		$I_C = 10\text{A}, I_B = 1.0\text{A}$	—	1.8	2.5	V
Delay Time*	$t_d$		—	0.05	0.5	$\mu\text{s}$
Rise Time*	$t_r$	$V_{CC} = 250\text{V}, I_C = 20\text{A}$	—	0.4	1.0	$\mu\text{s}$
Storage Time*	DS ES	$I_{B1} = 1\text{A}, -I_{B2} = 2.0\text{A}$	—	2.2	5.0	$\mu\text{s}$
			—	1.8	3.0	$\mu\text{s}$
Fall Time*	DS ES	$t_p = 50 \mu\text{sec}$	—	1.6	3.0	$\mu\text{s}$
			—	.45	1.0	$\mu\text{s}$
Diode Forward Voltage	$V_{FM}$	$I_{FM} = 10\text{A}$	—	1.95	3.20	V
		$I_{FM} = 25\text{A}$	—	2.8	4.00	V
		$I_{FM} = 25\text{A}, T_J = 150^\circ\text{C}$	—	2.75	4.00	V
Reverse Recovery time	$t_{rr}$	$I_{FM} = 25\text{A}, di/dt = 10\text{A}/\mu\text{sec}$ $R_{B1E} = .25\Omega$	—	3.85	10.0	$\mu\text{s}$
Forward Turn-On Time	$t_{ON}$	$I_{FM} = 25\text{A}, di/dt = 50\text{A}/\mu\text{sec}$	—	0.42	1.0	$\mu\text{s}$
Thermal Resistance, Junction to Case	$R_{\theta JC}$	Transistor Part	—	—	2.0	$^\circ\text{C}/\text{W}$
Thermal Resistance, Junction to Case	$R_{\theta JC}$	Diode Part	—	—	2.0	$^\circ\text{C}/\text{W}$

\*Resistive Load



Powerex, Inc., Hillis Street, Youngwood, Pennsylvania 15697 (412) 925-7272

**D66DS**  
**D66ES**  
 Fast Switching Single Darlington Transistor Module  
 20 Amperes/500-600-700 Volts

DC CURRENT GAIN (TYPICAL)

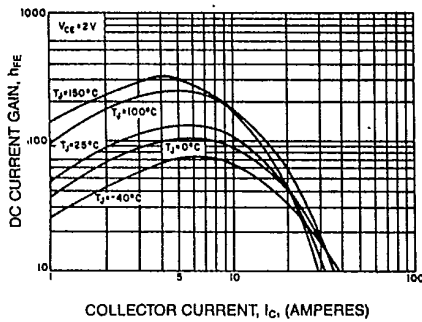

DC CURRENT GAIN (TYPICAL)

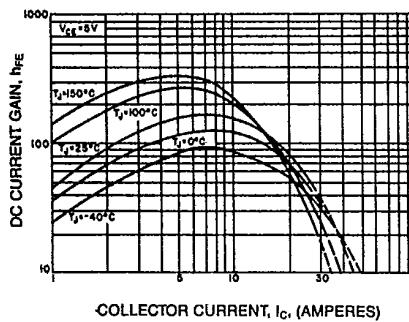

SATURATION VOLTAGE (TYPICAL)

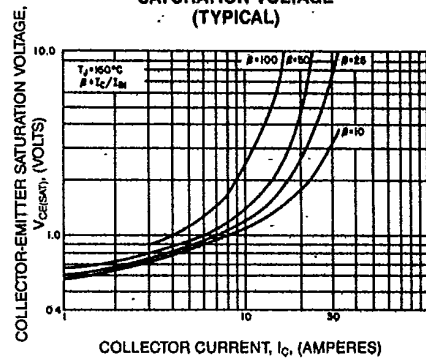

SATURATION VOLTAGE (TYPICAL)

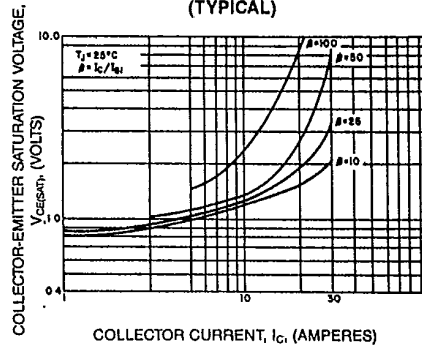

SATURATION VOLTAGE (TYPICAL)

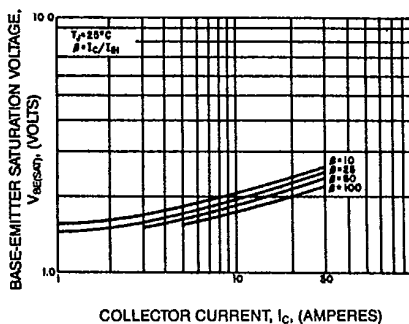

SATURATION VOLTAGE (TYPICAL)

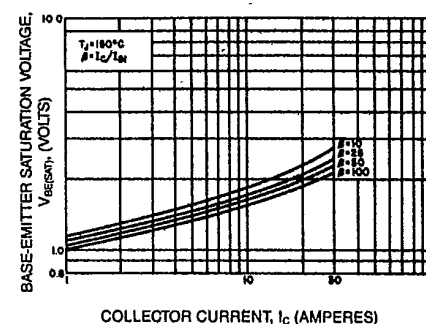

SWITCHING CHARACTERISTICS (TYPICAL)

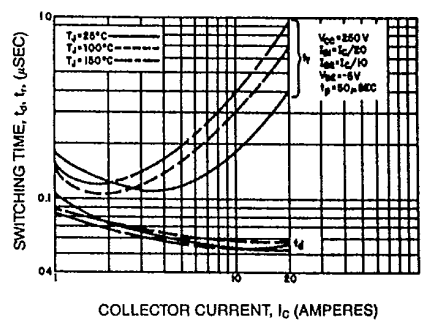

SWITCHING CHARACTERISTICS (TYPICAL)

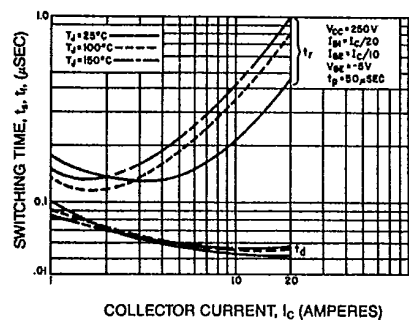

SWITCHING CHARACTERISTICS (TYPICAL)

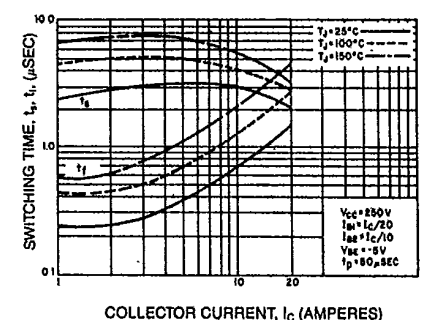



Powerex, Inc., Hillis Street, Youngwood, Pennsylvania 15697 (412) 925-7272

D66DS

D66ES

Fast Switching Single Darlington Transistor Module  
20 Amperes/500-600-700 Volts

SWITCHING CHARACTERISTICS (TYPICAL)

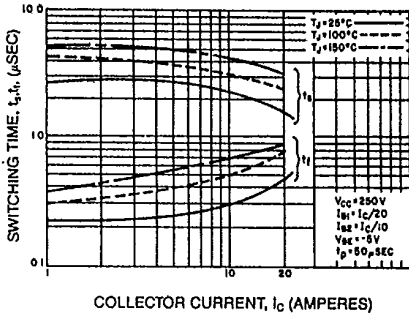

COLLECTOR-EMITTER SATURATION VOLTAGE (TYPICAL)

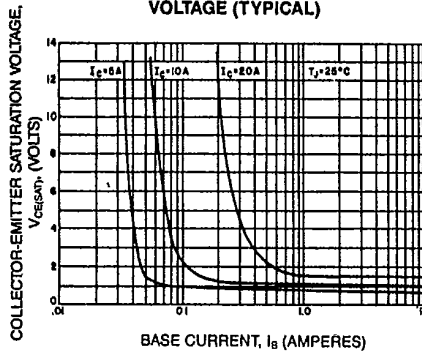

SWITCHING-TIME VS. BASE CURRENT (TYPICAL)

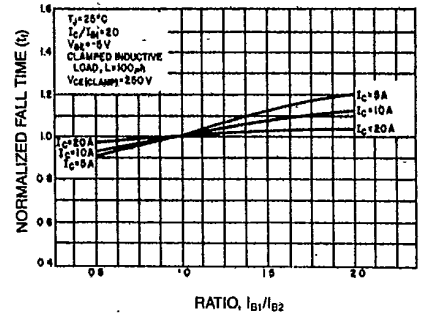

SWITCHING TIME VS. BASE CURRENT (TYPICAL)

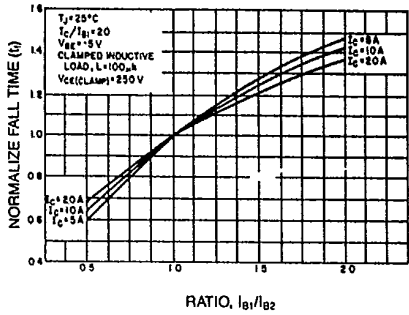

SWITCHING TIME VS. BASE CURRENT (TYPICAL)

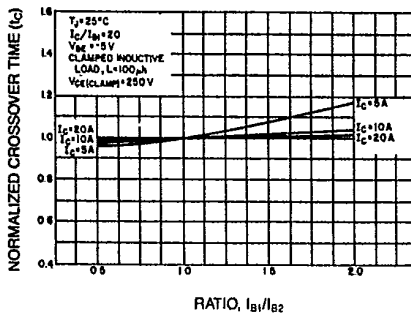

SWITCHING TIME VS. BASE CURRENT (TYPICAL)

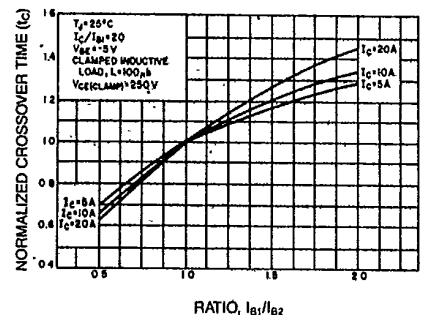

DIODE CHARACTERISTICS (TYPICAL)

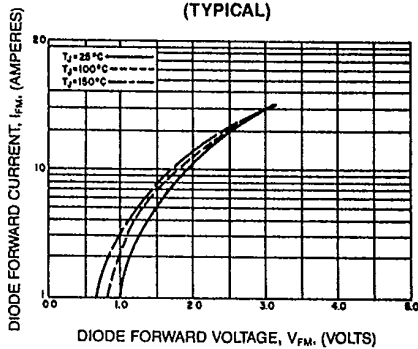

REVERSE BIAS SAFE OPERATING AREA (R.B.S.O.A.)

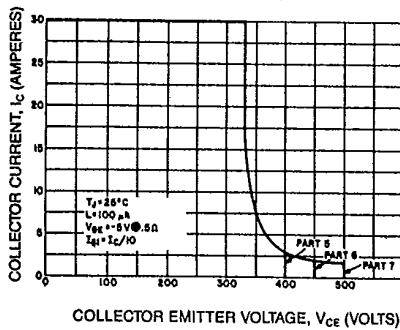

FORWARD BIAS SAFE OPERATING AREA (S.O.A.)

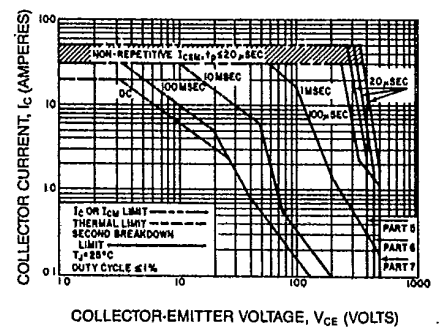



Powerex, Inc., Hillis Street, Youngwood, Pennsylvania 15697 (412) 925-7272

**D66DS**  
**D66ES**  
**Fast Switching Single Darlington Transistor Module**  
 20 Ampere/500-600-700 Volts

**DERATING FACTOR OF SAFE OPERATING AREA (S.O.A.)**

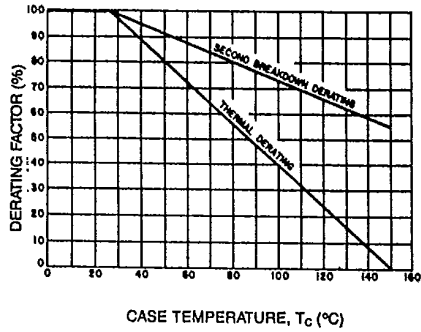

**TRANSIENT THERMAL IMPEDANCE CHARACTERISTICS (TRANSISTOR)**

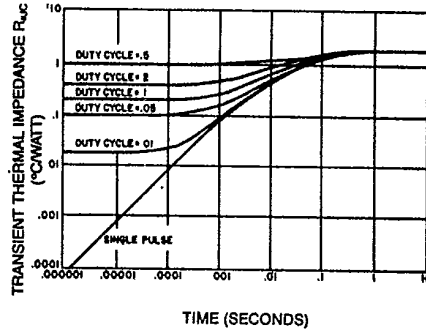

**Switching Time Test Circuit**

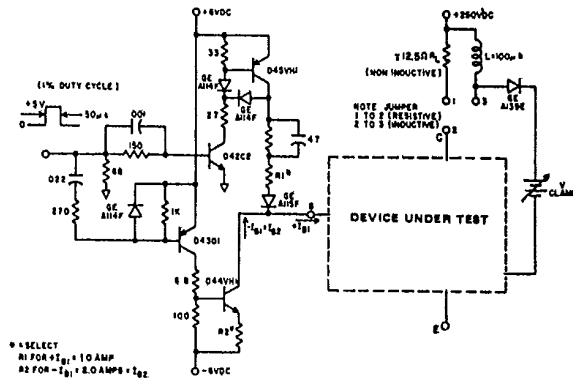



LittleDiode supplies new, hard to find or obsolete electronic components and semiconductors all over the world.

With over two million different components listed you are sure to find the part you need.

Feel free to visit us today at our online store:

[LittleDiode.com](http://LittleDiode.com)

Looking forward to providing you with the best possible service.