

AN5817NK

Multiplex Sound Demodulator IC for TV in the U.S.A.

Overview

The AN5817NK is a TV multiplex sound signal processor IC for TV in the U.S.A. It includes all multiplex sound demodulator functions needed for U.S.A. TV standard.

Features

- Single chip IC of TV multiplex sound demodulator for the USA standard (combined Zenith with dbx method)
- Only 4 adjustment points (two separation adjustments, one filter adjustment, and one VCO adjustment)
- Supply voltage : $9 \pm 1V$

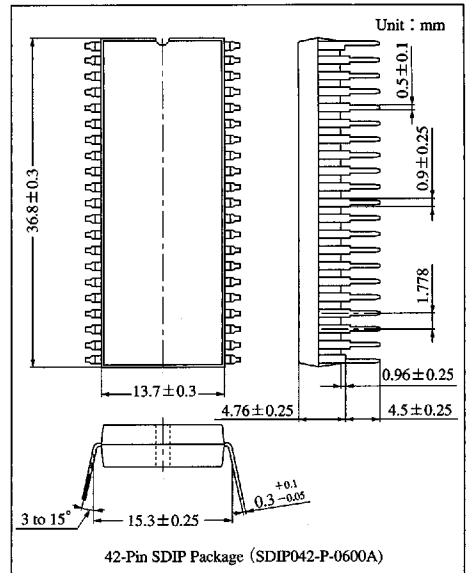

Block Diagram

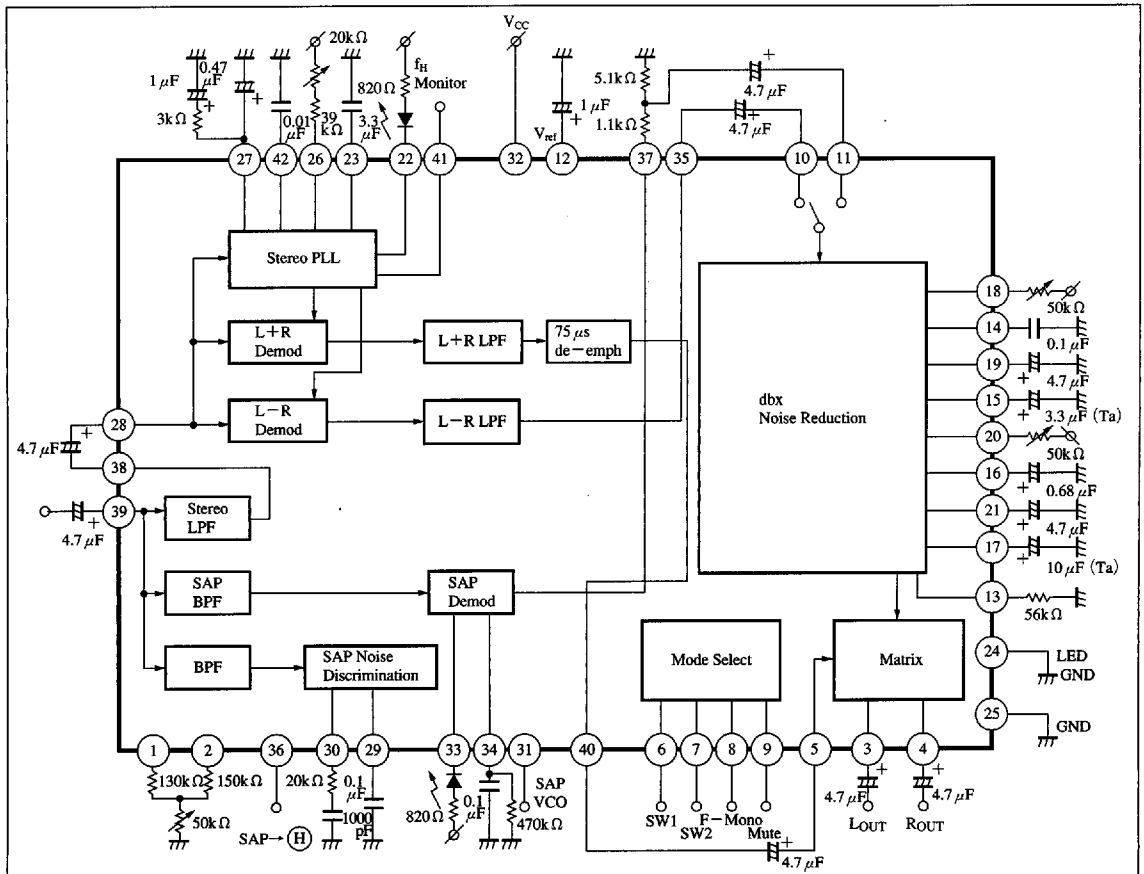

Absolute Maximum Ratings

Parameter	Symbol	Rating	Unit
Supply voltage	V_{CC}	11.0	V
Supply current	I_{CC}	50	mA
Power dissipation ^{Note 2)}	P_D	760	mW
LED driving current ^{Note 3)}	I_{LED}	20	mA
Operating ambient temperature ^{Note 1)}	T_{opr}	-20 to +75	°C
Storage temperature ^{Note 1)}	T_{stg}	-55 to +150	°C

Note 1) $T_a = 25^\circ\text{C}$ except operating ambient temperature and storage temperature.

Note 2) Allowable power dissipation of the package at $T_a = 70^\circ\text{C}$.

Note 3) Flow-in currents to Pin 22, 33

Recommended Operating Range ($T_a = 25^\circ\text{C}$)

Parameter	Symbol	Range
Operating supply voltage range	V_{CC}	8.0V to 10.0V

Electrical Characteristics ($V_{CC} = 9V$, $T_a = 25 \pm 2^\circ\text{C}$)

Parameter	Symbol	Condition	min	typ	max	Unit
Total circuit current	I_{CC}	No signal	22	30	38	mA
Monaural output level	$V_0(\text{Mon})$	$f = 1\text{kHz}$ (Mono.) 100% mod.	450	500	550	mVrms
Monaural frequency characteristics - 1	$V_1(\text{Mon})$	$f = 300\text{Hz}$ (Mono.) 30% mod.	-0.5	0	+0.5	dB
Monaural frequency characteristics - 2	$V_2(\text{Mon})$	$f = 8\text{kHz}$ (Mono.) 30% mod.	-1.7	-1.0	+0.3	dB
Monaural distortion rate	THD(Mon)	$f = 1\text{kHz}$ (Mono.) 100% mod.	—	—	0.7	%
Monaural noise level	$V_n(\text{Mon})$	Input short BPF (A curve)	—	—	-65	dBV
(L), (R) output voltage difference	$V_{LR}(\text{Mon})$	$f = 300\text{Hz}$ (Mono.) 100% mod.	-0.5	0	+0.5	dB
Stereo output level	$V_0(\text{st})$	$f = 1\text{kHz}$ (L (R) - only) 100% mod.	400	500	600	mVrms
Stereo frequency characteristics - 1	$V_1(\text{st})$	$f = 300\text{Hz}$ (L (R) - only) 30% mod.	-0.7	0	+0.7	dB
Stereo frequency characteristics - 2	$V_2(\text{st})$	$f = 3\text{kHz}$ (L (R) - only) 30% mod.	-1.0	0	+1.0	dB
Stereo frequency characteristics - 3	$V_3(\text{st})$	$f = 8\text{kHz}$ (L (R) - only) 30% mod.	-2.0	-1.0	0	dB
Stereo distortion rate	THD(st)	$f = 1\text{kHz}$ (L (R) - only) 100% mod.	—	—	1.0	%
Stereo noise level	$V_n(\text{st})$	$f = 15.73\text{kHz}$ (f_H) $v = 0.084V_{P-P}$, BPF	—	—	-65	dBV
Stereo discrimination level	$V_{TH}(\text{st})$	$f = 15.73\text{kHz}$ (f_H)	10	15	22	mVrms
Stereo discrimination hysteresis	$V_{HY}(\text{st})$	$f = 15.73\text{kHz}$ (f_H)	-10	—	-3	dB
SAP output level	$V_0(\text{SAP})$	$f = 1\text{kHz}$ (SAP) 100% mod.	400	500	600	mVrms
SAP frequency characteristics - 1	$V_1(\text{SAP})$	$f = 300\text{Hz}$ (SAP) 30% mod.	-1.0	0	+1.5	dB
SAP frequency characteristics - 2	$V_2(\text{SAP})$	$f = 3\text{kHz}$ (SAP) 30% mod.	-1.5	0	+1.0	dB
SAP distortion rate	THD(SAP)	$f = 1\text{kHz}$ (SAP) 100%	—	—	1.5	%

※ Input level (at 100% modulation) L + R : $0.424V_{P-P}$, L - R : $0.848V_{P-P}$, pilot : $0.084V_{P-P}$, SAP : $0.254V_{P-P}$

■ Electrical Characteristics (cont.) ($V_{CC}=9V$, $T_a=25\pm 2^\circ C$)

Parameter	Symbol	Condition	min	typ	max	Unit
SAP noise level	V_n (SAP)	$f=78.7kHz$ ($5f_H$) $v=0.42V_{P-P}$, BPF	—	—	-75	dBV
SAP discrimination level	V_{TH} (SAP)	$f=78.7kHz$ ($5f_H$)	20	—	60	mVrms
SAP discrimination hysteresis	V_{HY} (SAP)	$f=78.7kHz$ ($5f_H$)	-4.0	—	-1.0	dB
SAP-OUT output level	V_0 (SAPO)	$f=1kHz$ (SAP, dbx-off) 100% mod.	400	500	600	mVrms
SAP-OUT frequency characteristics -1	V_1 (SAPO)	$f=300Hz$ (SAP, dbx-off) 30% mod.	-0.5	0	+0.5	dB
SAP-OUT frequency characteristics -2	V_2 (SAPO)	$f=3kHz$ (SAP, dbx-off) 30% mod.	-0.5	0	+0.5	dB
SAP-OUT distortion rate	THD (SAPO)	$f=1kHz$ (SAP, dbx-off) 100% mod.	—	—	2.0	%
SAP-OUT noise level	V_n (SAPO)	$f=78.7kHz$ ($5f_H$) $v=0.42V_{P-P}$, BPF	—	—	-46	dBV
SAP→Stereo crosstalk	CT ₁	(SAP) 1kHz, 100% mod. (Stereo) pilot-signal	—	—	-50	dB
Stereo→SAP crosstalk	CT ₂	(Stereo) 1kHz, 100% mod. (SAP) carrier-signal	—	—	-50	dB
Mute	Mute	(Mon) 1kHz, 100% mod.	—	—	-56	dB
Stereo separation (30%) -1	Sep ₃₀₋₁	$f=300Hz$ L (R) -only 30% mod.	(25)	—	—	dB
Stereo separation (30%) -2	Sep ₃₀₋₂	$f=1kHz$ L (R) -only 30% mod.	(25)	—	—	dB
Stereo separation (30%) -3	Sep ₃₀₋₃	$f=3kHz$ L (R) -only 30% mod.	(25)	—	—	dB
Stereo separation (30%) -4	Sep ₃₀₋₄	$f=8kHz$ L (R) -only 30% mod.	(20)	—	—	dB
Stereo separation (100%) -1	Sep ₁₀₀₋₁	$f=300Hz$ L (R) -only 100% mod.	(25)	—	—	dB
Stereo separation (100%) -2	Sep ₁₀₀₋₂	$f=1kHz$ L (R) -only 100% mod.	(20)	—	—	dB
Stereo separation (100%) -3	Sep ₁₀₀₋₃	$f=3kHz$ L (R) -only 100% mod.	(25)	—	—	dB
Stereo separation (100%) -4	Sep ₁₀₀₋₄	$f=8kHz$ L (R) -only 100% mod.	(15)	—	—	dB
Stereo separation (10%) -1	Sep ₁₀₋₁	$f=300Hz$ L (R) -only 10% mod.	(25)	—	—	dB
Stereo separation (10%) -2	Sep ₁₀₋₂	$f=1kHz$ L (R) -only 10% mod.	(20)	—	—	dB
Stereo separation (10%) -3	Sep ₁₀₋₃	$f=3kHz$ L (R) -only 10% mod.	(25)	—	—	dB
Stereo separation (10%) -4	Sep ₁₀₋₄	$f=8kHz$ L (R) -only 10% mod.	(20)	—	—	dB
SAP→Mono crosstalk	CT ₃	(SAP) 1kHz 100% mod. (Mono) 1kHz 0% mod.	—	(-53)	—	dB
Mono→SAP crosstalk	CT ₄	(SAP) 1kHz 0% mod. (Mono) 1kHz 100% mod.	—	(-60)	(-56)	dB

Note) The characteristics value in parentheses is not a guaranteed value, but reference one on design.

Pin Descriptions

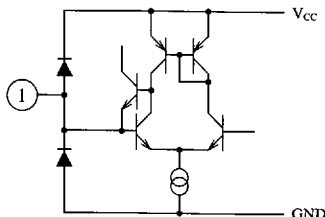
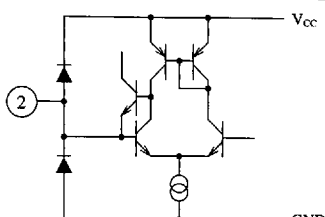
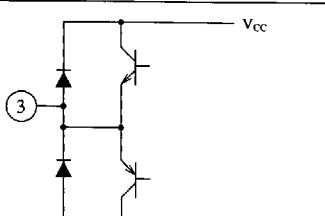
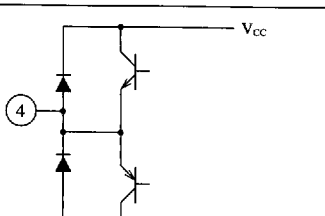
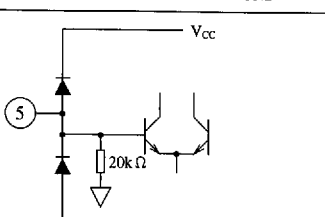
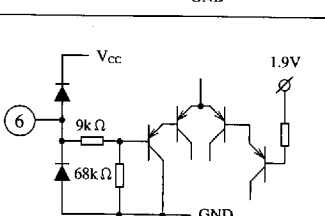
Pin No.	Pin name	Pin voltage (V _{cc} =9V)	Equivalent circuit	Description
1	dbx filter adjustment	1.2V		Adjustment of dbx filter control current
2	SAP0/stereo filter adj.	1.2V		Adjustment of SAP/stereo filter control current
3	L output	4.7V		(L) Line-Out output
4	R output	4.7V		(R) Line-Out output
5	Matrix (L+R) input	4.7V		Matrix Circuit (L+R) signal input
6	SAP mode change-over	0V		Under the SAP output condition, Lout Rout H (L+R) (SAP) more than 2.5V L (SAP) (SAP) less than 0.8V

ICs for TV

Pin Descriptions (cont.)

Pin No.	Pin name	Pin voltage ($V_{CC}=9V$)	Equivalent circuit	Description
7	Stereo/SAP change-over	0V		H : Stereo output mode, more than 2.5V L : SAP output mode, up to 0.8V
8	Forced monaural switching	0V		H : (more than 4.2V) Stereo output mode M : (2.2V to 3.2V) Forced monaural mode LED off L : (Up to 0.8V) Forced monaural mode LED on
9	Mute switching	0V		H : Mute mode Output mute, more than 2.5V LED off
10	L-R dbx input	4.7V		dbx NR input for L-R signal
11	SAP dbx input	4.7V		dbx NR input for SAP signal
12	Reference	4.5V		Stabilizing signal for reference power supply

Pin Descriptions (cont.)

Pin No.	Pin name	Pin voltage ($V_{CC}=9V$)	Equivalent circuit	Description
13	dbx timing current	1.2V		Control of the timing current for dbx r.m.s. value detection
14	Spectral level sensor input	4.7V		Input for the r.m.s. value detection circuit for variable emphasis
15	Spectral timing	0.2V		Control of the r.m.s. value detection recovery-time for variable emphasis
16	Wide-band level sensor input	4.7V		Input for the r.m.s. value detection circuit for wide-band expander
17	Wide-band timing	0.2V		Control of the r.m.s. value detection recovery-time for wide-band expander
18	Spectral level adjustment	8.0V		Control of the level of variable emphasis

ICs for
TV

Pin Descriptions (cont.)

Pin No.	Pin name	Pin voltage ($V_{CC}=9V$)	Equivalent circuit	Description
19	Spectral CCA offset elimination	4.7V		To eliminate the DC offset for variable emphasis CCA
20	Wide-band level adjustment	8.0V		To adjust the level of wide-band expander
21	Wide-band CCA offset elimination	4.7V		To eliminate the DC offset for wide-band expander CCA
22	Stereo LED	—		To connect the stereo LED
23	Pilot signal detection	6.8V		To detect the stereo pilot signal
24	LED GND	0V	—	GND pin for LED lighting circuit

■ Pin Descriptions (cont.)

Pin No.	Pin name	Pin voltage (V _{CC} =9V)	Equivalent circuit	Description
25	GND	0V		Ground
26	Stereo VCO adjustment	7.8V		To adjust the stereo PLL-VCO oscillation frequency
27	Stereo PLL filter	4.7V		To connect the stereo PLL low pass filter
28	Stereo demodulation input	4.7V		Input pin of the stereo demodulation circuit
29	SAP noise level setting	3V		To detect the noise of SAP-malfunction prevention-circuit (Mutes the SAP demodulation at noise detection)
30	SAP noise level setting	3V		To set the noise level of SAP-malfunction prevention-circuit

ICs for TV

Pin Descriptions (cont.)

Pin No.	Pin name	Pin voltage ($V_{CC}=9V$)	Equivalent circuit	Description
31	SAP VCO adjustment	0.1V		Fine adjustment of oscillation frequency of SAP-VCO (Normally, not used)
32	V_{CC}	9V		V_{CC} pin
33	SAP-LED	—		To a SAP-LED
34	SAP carrier detection	2V		To detect the carrier level of SAP-signal
35	(L-R) demodulation output	4.0V		(L-R) demodulation signal-output
36	SAP output detection	0V (9V at SAP ON 9V)		When SAP is output to the line-out, HIGH (9V) is output.

■ Pin Descriptions (cont.)

Pin No.	Pin name	Pin voltage (V _{CC} =9V)	Equivalent circuit	Description
37	SAP demodulation output	3.5V		SAP-demodulation signal-output
38	Stereo filter output	4.0V		Stereo-filter output
39	Composite input	4.7V		Composite-signal input
40	(L+R) demodulation output	4.0V		(L+R) demodulation-signal output
41	f _H monitor output	4.3V 2.3V Stereo at LED ON		Stereo-PLL VCO-oscillation monitor
42	Quasi-sine wave filter	4.7V		To a low-pass filter of the quasi-sine-wave circuit

ICs for TV

This datasheet has been downloaded from:

www.DatasheetCatalog.com

Datasheets for electronic components.



LittleDiode supplies new, hard to find or obsolete electronic components and semiconductors all over the world.

With over two million different components listed you are sure to find the part you need.

Feel free to visit us today at our online store:

LittleDiode.com

Looking forward to providing you with the best possible service.