

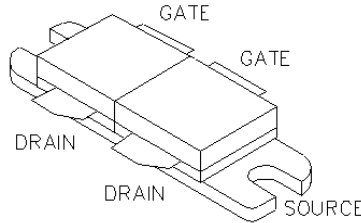

General Description

Silicon VDMOS and LDMOS transistors designed specifically for broadband RF applications. Suitable for Military Radios, Cellular and Paging Amplifier Base Stations, Broadcast FM/AM, MRI, Laser Driver and others.

"Polyfet"™ process features gold metal for greatly extended lifetime. Low output capacitance and high F_t enhance broadband performance



PATENTED GOLD METALIZED SILICON GATE ENHANCEMENT MODE RF POWER VDMOS TRANSISTOR

130 Watts Gemini

Package Style AR

HIGH EFFICIENCY, LINEAR, HIGH GAIN, LOW NOISE

ABSOLUTE MAXIMUM RATINGS (TC = 25 °C)

| Total Device Dissipation | Junction to Case Thermal Resistance | Maximum Junction Temperature | Storage Temperature | DC Drain Current | Drain to Gate Voltage | Drain to Source Voltage | Gate to Source Voltage |
|--------------------------|-------------------------------------|------------------------------|---------------------|------------------|-----------------------|-------------------------|------------------------|
| 390 Watts | 0.45 °C/W | 200 °C | -65 °C to 150 °C | 20 A | 70 V | 70V | 30V |

RF CHARACTERISTICS (130 WATTS OUTPUT)

| SYMBOL | PARAMETER | MIN | TYP | MAX | UNITS | TEST CONDITIONS |
|--------|--------------------------|-----|-----|------|----------|--|
| Gps | Common Source Power Gain | 10 | | | dB | $I_{dq} = 2 A, V_{ds} = 28.0 V, F = 400 MHz$ |
| n | Drain Efficiency | | 60 | | % | $I_{dq} = 2 A, V_{ds} = 28.0 V, F = 400 MHz$ |
| VSWR | Load Mismatch Tolerance | | | 20:1 | Relative | $I_{dq} = 2 A, V_{ds} = 28.0 V, F = 400 MHz$ |

ELECTRICAL CHARACTERISTICS (EACH SIDE)

| SYMBOL | PARAMETER | MIN | TYP | MAX | UNITS | TEST CONDITIONS |
|--------|------------------------------------|-----|------|-----|-------|---|
| Bvdss | Drain Breakdown Voltage | 65 | | | V | $I_{ds} = 0.25 A, V_{gs} = 0V$ |
| Idss | Zero Bias Drain Current | | | 5 | mA | $V_{ds} = 28.0 V, V_{gs} = 0V$ |
| Igss | Gate Leakage Current | | | 1 | uA | $V_{ds} = 0 V, V_{gs} = 30V$ |
| Vgs | Gate Bias for Drain Current | 1 | | 7 | V | $I_{ds} = 0.5 A, V_{gs} = V_{ds}$ |
| gM | Forward Transconductance | | 4 | | Mho | $V_{ds} = 10V, V_{gs} = 5V$ |
| Rdson | Saturation Resistance | | 0.25 | | Ohm | $V_{gs} = 20V, I_{ds} = 20 A$ |
| Idsat | Saturation Current | | 27.5 | | Amp | $V_{gs} = 20V, V_{ds} = 10V$ |
| Ciss | Common Source Input Capacitance | | 165 | | pF | $V_{ds} = 28.0 V, V_{as} = 0V, F = 1 MHz$ |
| Crss | Common Source Feedback Capacitance | | 20 | | pF | $V_{ds} = 28.0 V, V_{as} = 0V, F = 1 MHz$ |
| Coss | Common Source Output Capacitance | | 100 | | pF | $V_{ds} = 28.0 V, V_{as} = 0V, F = 1 MHz$ |

F1020

POUT VS PIN GRAPH

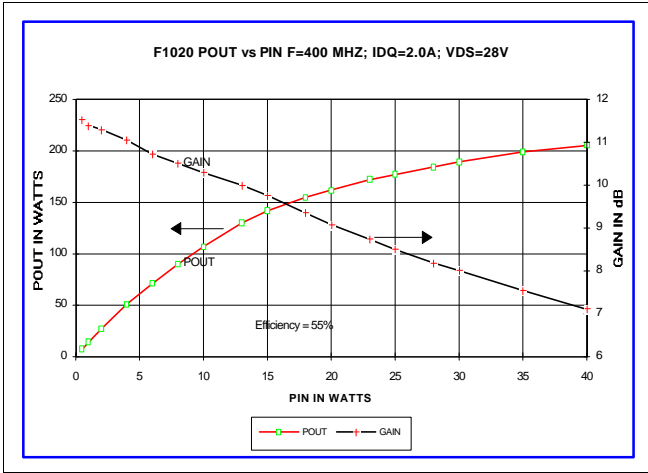

CAPACITANCE VS VOLTAGE

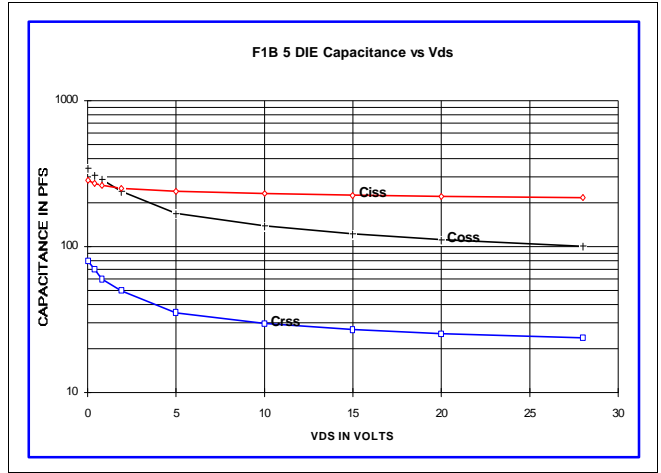

IV CURVE

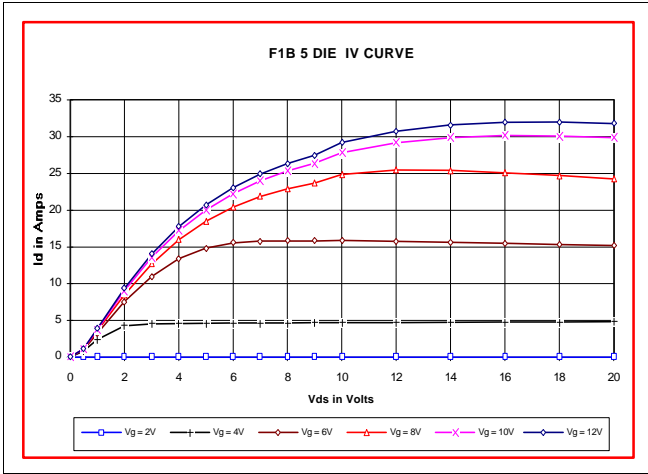

ID AND GM VS VGS

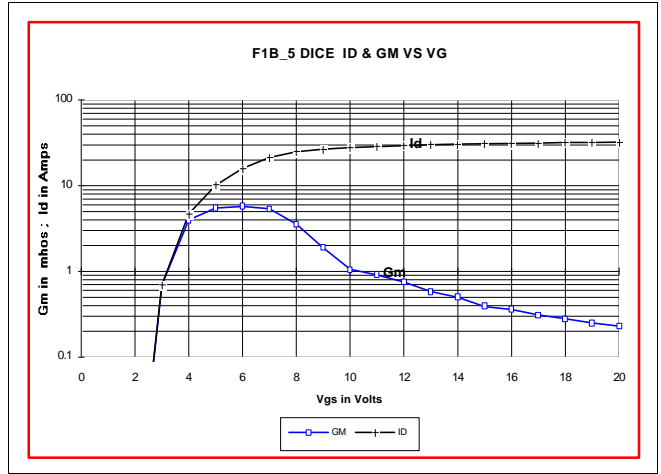

S11 AND S22 SMITH CHART

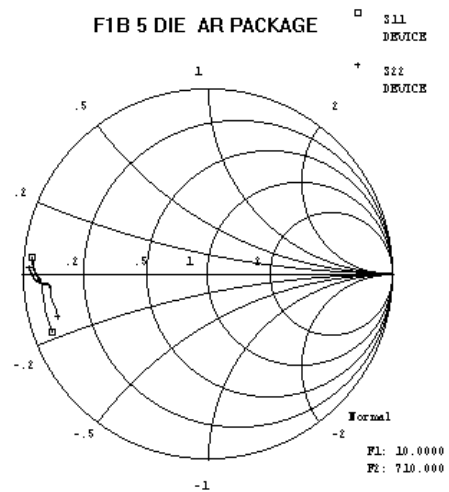

PACKAGE DIMENSIONS IN INCHES

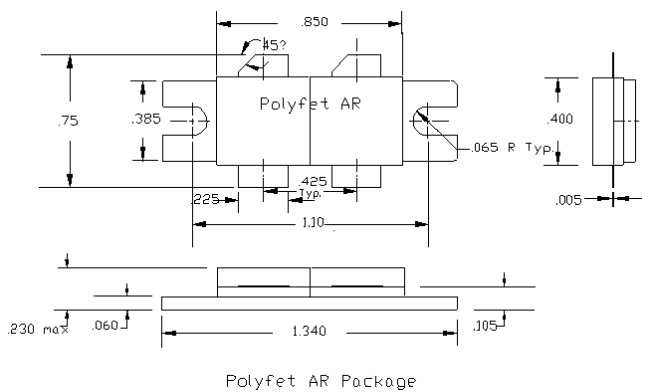



LittleDiode supplies new, hard to find or obsolete electronic components and semiconductors all over the world.

With over two million different components listed you are sure to find the part you need.

Feel free to visit us today at our online store:

LittleDiode.com

Looking forward to providing you with the best possible service.