

POWER MOS V® FREDFET

Power MOS V® is a new generation of high voltage N-Channel enhancement mode power MOSFETs. This new technology minimizes the JFET effect, increases packing density and reduces the on-resistance. Power MOS V® also achieves faster switching speeds through optimized gate layout.

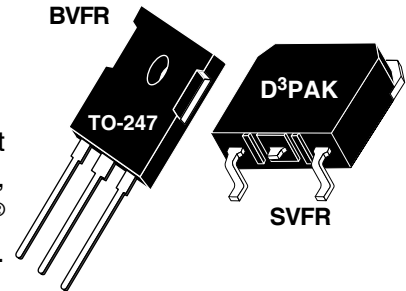

- Avalanche Energy Rated
- Lower Leakage
- Faster Switching
- **FAST RECOVERY BODY DIODE**
- TO-247 or Surface Mount D³PAK Package

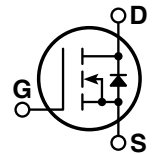

MAXIMUM RATINGS

 All Ratings: $T_C = 25^\circ\text{C}$ unless otherwise specified.

| Symbol | Parameter | APT1001RBVFR_SVFR | UNIT |
|----------------|--|-------------------|-------|
| V_{DSS} | Drain-Source Voltage | 1000 | Volts |
| I_D | Continuous Drain Current @ $T_C = 25^\circ\text{C}$ | 11 | Amps |
| I_{DM} | Pulsed Drain Current ^① | 44 | |
| V_{GS} | Gate-Source Voltage Continuous | ± 30 | Volts |
| V_{GSM} | Gate-Source Voltage Transient | ± 40 | |
| P_D | Total Power Dissipation @ $T_C = 25^\circ\text{C}$ | 278 | Watts |
| | Linear Derating Factor | 2.22 | W/°C |
| T_J, T_{STG} | Operating and Storage Junction Temperature Range | -55 to 150 | °C |
| T_L | Lead Temperature: 0.063" from Case for 10 Sec. | 300 | |
| I_{AR} | Avalanche Current ^① (Repetitive and Non-Repetitive) | 11 | Amps |
| E_{AR} | Repetitive Avalanche Energy ^① | 30 | mJ |
| E_{AS} | Single Pulse Avalanche Energy ^④ | 1210 | |

STATIC ELECTRICAL CHARACTERISTICS

| Symbol | Characteristic / Test Conditions | MIN | TYP | MAX | UNIT |
|--------------|---|------|-----|-----------|---------------|
| BV_{DSS} | Drain-Source Breakdown Voltage ($V_{GS} = 0V, I_D = 250\mu\text{A}$) | 1000 | | | Volts |
| $R_{DS(on)}$ | Drain-Source On-State Resistance ^② ($V_{GS} = 10V, I_D = 5.5A$) | | | 1.00 | Ohms |
| I_{DSS} | Zero Gate Voltage Drain Current ($V_{DS} = 1000V, V_{GS} = 0V$) | | | 250 | μA |
| | Zero Gate Voltage Drain Current ($V_{DS} = 800V, V_{GS} = 0V, T_C = 125^\circ\text{C}$) | | | 1000 | |
| I_{GSS} | Gate-Source Leakage Current ($V_{GS} = \pm 30V, V_{DS} = 0V$) | | | ± 100 | nA |
| $V_{GS(th)}$ | Gate Threshold Voltage ($V_{DS} = V_{GS}, I_D = 1\text{mA}$) | 2 | | 4 | Volts |

 **CAUTION:** These Devices are Sensitive to Electrostatic Discharge. Proper Handling Procedures Should Be Followed.

DYNAMIC CHARACTERISTICS

APT1001RBVFR_SVFR

| Symbol | Characteristic | Test Conditions | MIN | TYP | MAX | UNIT |
|--------------|------------------------------|--|-----|------|-----|------|
| C_{iss} | Input Capacitance | $V_{GS} = 0V$ $V_{DS} = 25V$ $f = 1\text{ MHz}$ | | 3050 | | pF |
| C_{oss} | Output Capacitance | | | 280 | | |
| C_{rss} | Reverse Transfer Capacitance | | | 135 | | |
| Q_g | Total Gate Charge ③ | $V_{GS} = 10V$ $V_{DD} = 500V$ $I_D = 11A @ 25^\circ C$ | | 150 | | nC |
| Q_{gs} | Gate-Source Charge | | | 16 | | |
| Q_{gd} | Gate-Drain ("Miller") Charge | | | 70 | | |
| $t_{d(on)}$ | Turn-on Delay Time | $V_{GS} = 15V$ $V_{DD} = 500V$ $I_D = 11A @ 25^\circ C$ $R_G = 1.6\Omega$ | | 12 | | ns |
| t_r | Rise Time | | | 11 | | |
| $t_{d(off)}$ | Turn-off Delay Time | | | 55 | | |
| t_f | Fall Time | | | 12 | | |

SOURCE-DRAIN DIODE RATINGS AND CHARACTERISTICS

| Symbol | Characteristic / Test Conditions | MIN | TYP | MAX | UNIT |
|-----------|---|---------------------|-----|-----|---------|
| I_S | Continuous Source Current (Body Diode) | | | 11 | Amps |
| I_{SM} | Pulsed Source Current ① (Body Diode) | | | 44 | Amps |
| V_{SD} | Diode Forward Voltage ② ($V_{GS} = 0V, I_S = -11A$) | | | 1.3 | Volts |
| dv/dt | Peak Diode Recovery dv/dt ⑤ | | | 18 | V/ns |
| t_{rr} | Reverse Recovery Time ($I_S = -11A, di/dt = 100A/\mu s$) | $T_j = 25^\circ C$ | | 200 | ns |
| | | $T_j = 125^\circ C$ | | 350 | |
| Q_{rr} | Reverse Recovery Charge ($I_S = -11A, di/dt = 100A/\mu s$) | $T_j = 25^\circ C$ | | 0.7 | μC |
| | | $T_j = 125^\circ C$ | | 1.5 | |
| I_{RRM} | Peak Recovery Current ($I_S = -11A, di/dt = 100A/\mu s$) | $T_j = 25^\circ C$ | | 11 | Amps |
| | | $T_j = 125^\circ C$ | | 16 | |

THERMAL CHARACTERISTICS

| Symbol | Characteristic | MIN | TYP | MAX | UNIT |
|-----------------|---------------------|-----|-----|------|--------------|
| $R_{\theta JC}$ | Junction to Case | | | 0.45 | $^\circ C/W$ |
| $R_{\theta JA}$ | Junction to Ambient | | | 40 | |

① Repetitive Rating: Pulse width limited by maximum junction temperature

② Pulse Test: Pulse width < 380 μs , Duty Cycle < 2%

③ See MIL-STD-750 Method 3471

④ Starting $T_j = +25^\circ C, L = 20.0mH, R_G = 25\Omega, \text{Peak } I_L = 11A$

⑤ dv/dt numbers reflect the limitations of the test circuit rather than the device itself. $I_S \leq -I_D 11A, di/dt \leq 700A/\mu s, v_R \leq 1000V, T_j \leq 150^\circ C$

APT Reserves the right to change, without notice, the specifications and information contained herein.

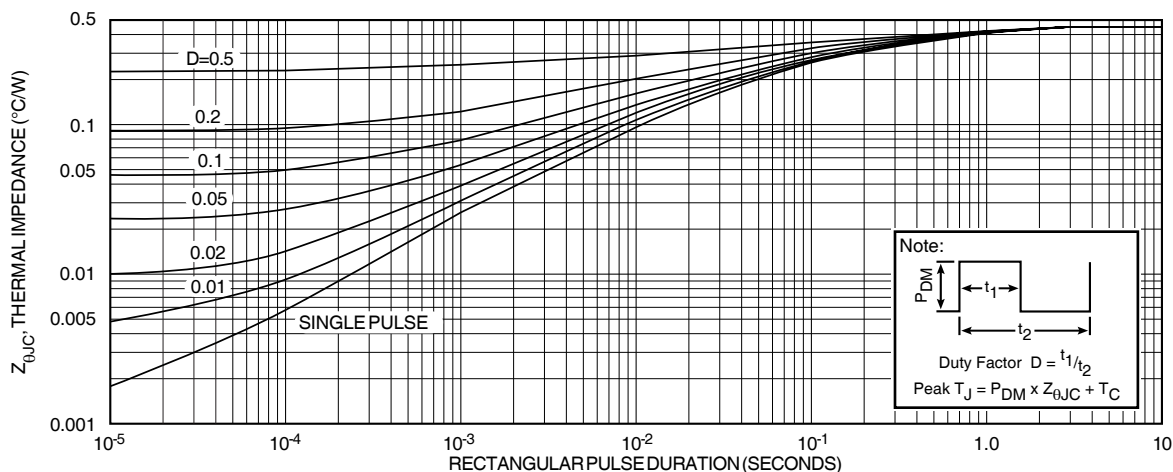

FIGURE 1, MAXIMUM EFFECTIVE TRANSIENT THERMAL IMPEDANCE, JUNCTION-TO-CASE vs PULSE DURATION

Typical Performance Curves

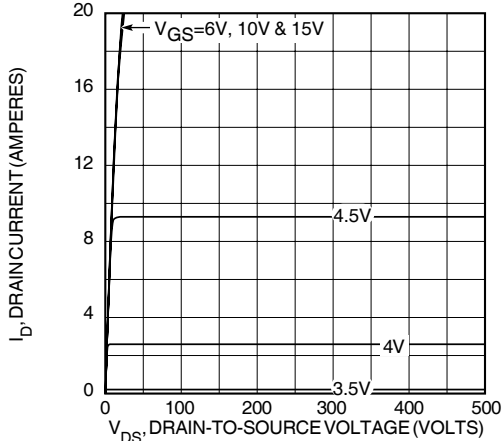

FIGURE 2, TYPICAL OUTPUT CHARACTERISTICS

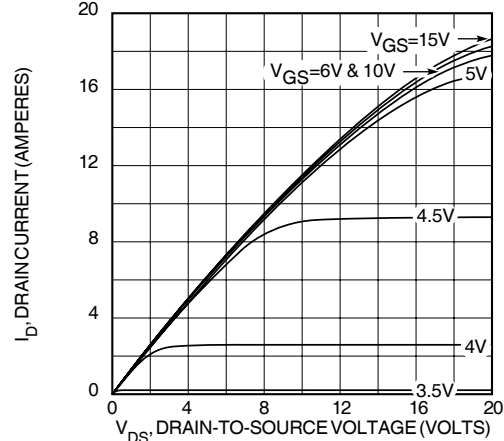

FIGURE 3, TYPICAL OUTPUT CHARACTERISTICS

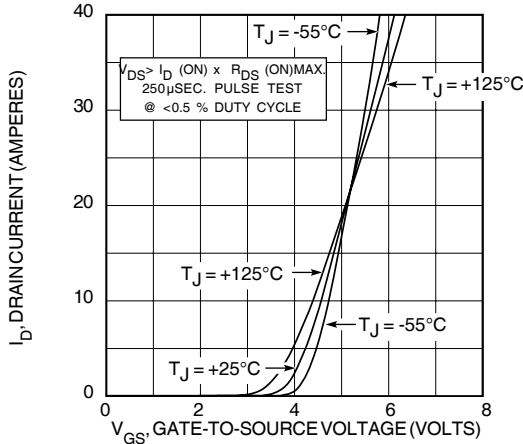

FIGURE 4, TYPICAL TRANSFER CHARACTERISTICS

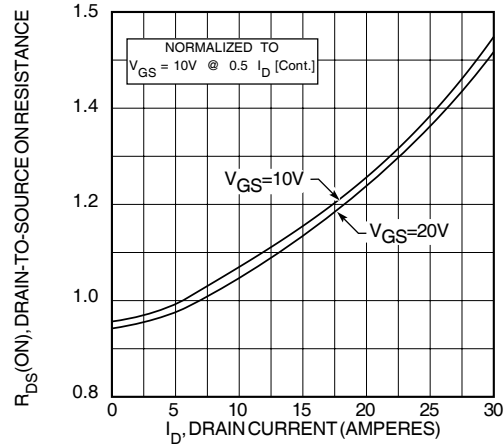

FIGURE 5, $R_{DS(ON)}$ vs DRAIN CURRENT

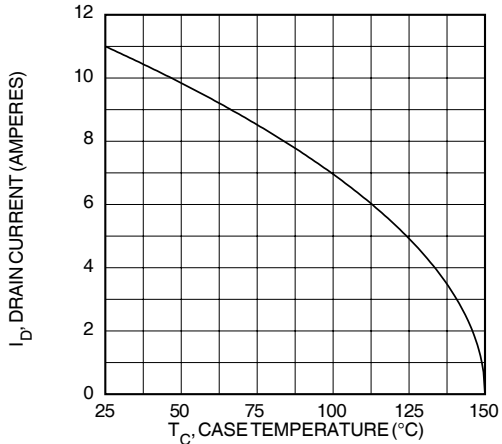

FIGURE 6, MAXIMUM DRAIN CURRENT vs CASE TEMPERATURE

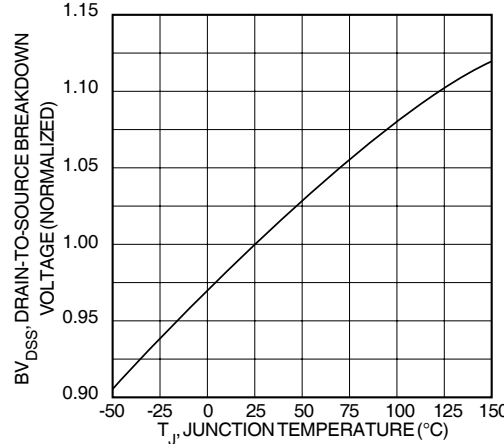

FIGURE 7, BREAKDOWN VOLTAGE vs TEMPERATURE

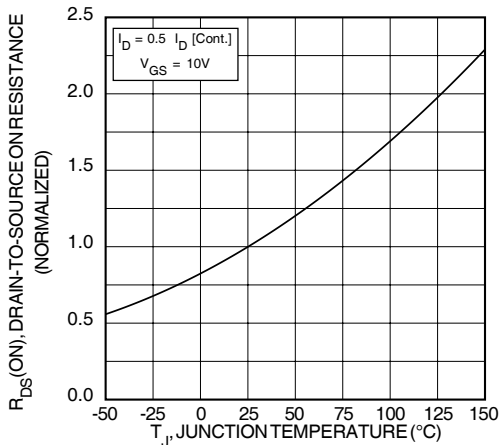

FIGURE 8, ON-RESISTANCE vs. TEMPERATURE

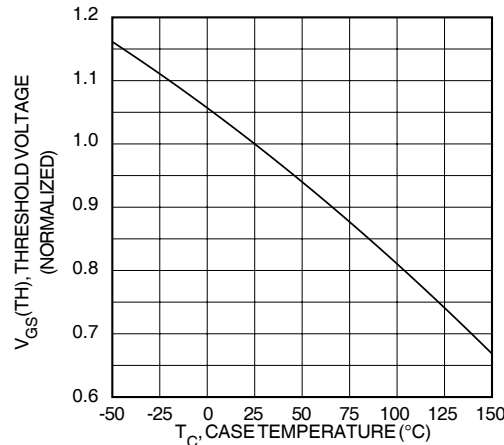

FIGURE 9, THRESHOLD VOLTAGE vs TEMPERATURE

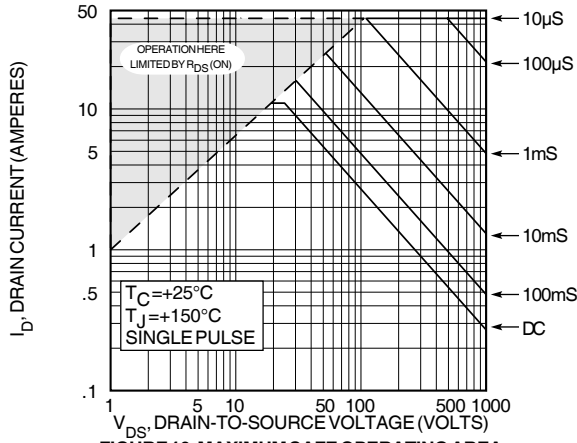

FIGURE 10, MAXIMUM SAFE OPERATING AREA

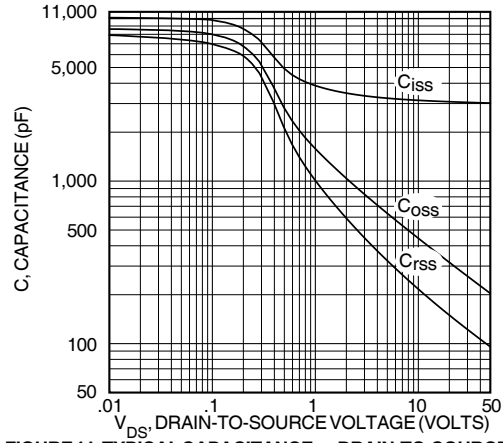

FIGURE 11, TYPICAL CAPACITANCE vs DRAIN-TO-SOURCE VOLTAGE

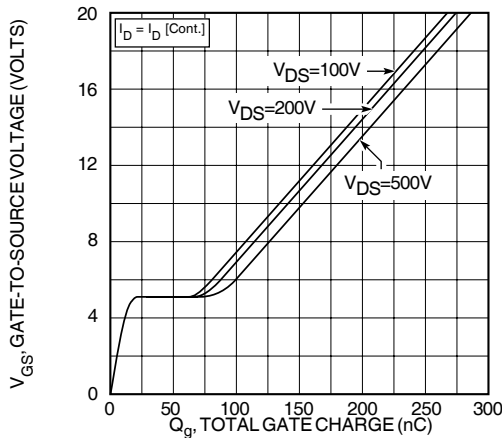

FIGURE 12, GATE CHARGES vs GATE-TO-SOURCE VOLTAGE

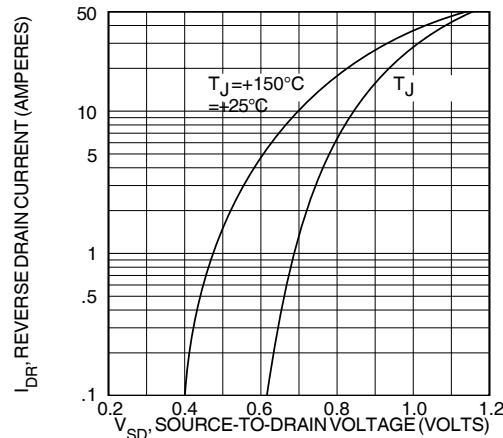
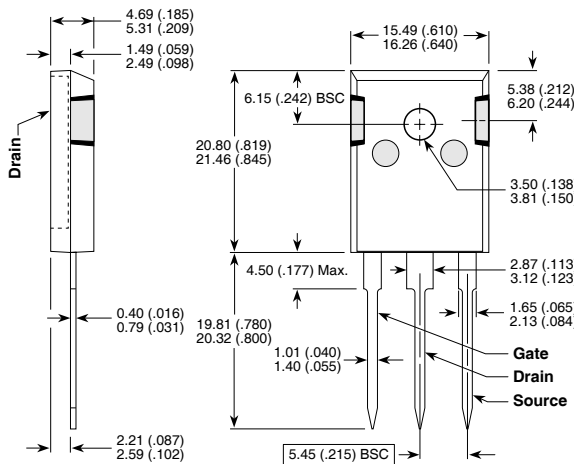

FIGURE 13, TYPICAL SOURCE-DRAIN DIODE FORWARD VOLTAGE

TO-247 Package Outline (BVFR)



Dimensions in Millimeters and (Inches)

D³PAK Package Outline (SVFR)

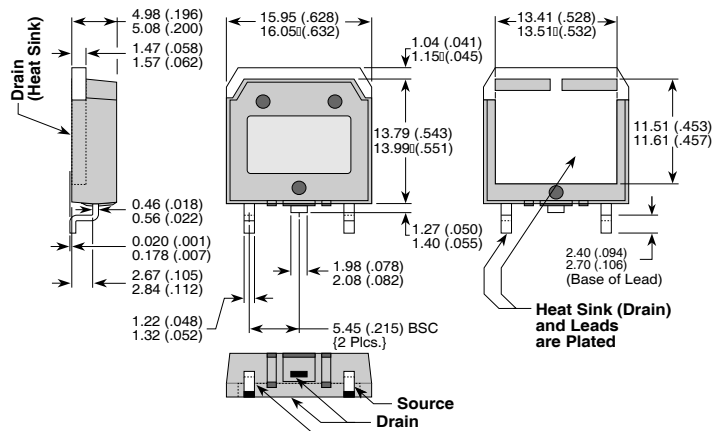

Dimensions in Millimeters (Inches)



LittleDiode supplies new, hard to find or obsolete electronic components and semiconductors all over the world.

With over two million different components listed you are sure to find the part you need.

Feel free to visit us today at our online store:

LittleDiode.com

Looking forward to providing you with the best possible service.