

Powerex, Inc., 200 Hillis Street, Youngwood, Pennsylvania 15697-1800 (412) 925-7272
 Powerex, Europe, S.A. 428 Avenue G. Durand, BP107, 72003 Le Mans, France (43) 41.14.14

Phase Control SCR
 590 Amperes Average
 1200 Volts

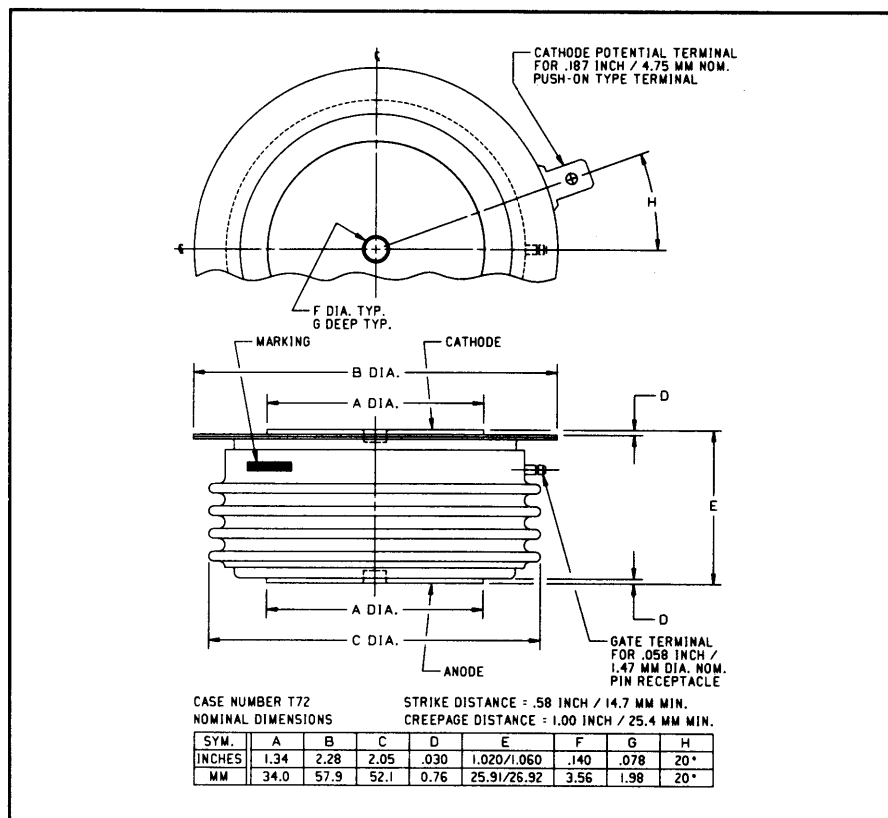

C390__X555 (Outline Drawing)

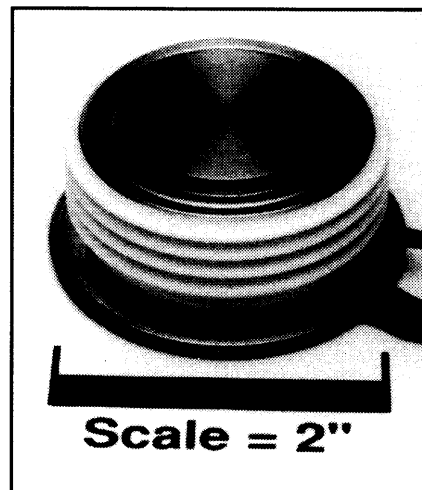

C390__X555 Phase Control SCR
 590 Amperes Average, 1200 Volts

Description:

Powerex Silicon Controlled Rectifiers (SCR) are designed for phase control applications. These are all-diffused, Press-Pak (Pow-R-Disc) devices employing the field-proven amplifying (di/namic) gate.

Features:

- Low On-State Voltage
- High di/dt
- High dv/dt
- Hermetic Packaging
- Excellent Surge and I²t Ratings
- High Temperature Operation

Applications:

- Power Supplies
- Battery Chargers
- Motor Control

Ordering Information:

Select the complete nine or ten digit part number you desire from the table, i.e. C390PBX555 is a 1200 Volt, 590 Ampere Phase Control SCR.

Type	Voltage		Current
	V _{DRM} V _{RRM}	Code	I _{T(av)}
C390__X555	600	M	590
	800	N	
	1000	P	
	1200	PB	



Powerex, Inc., 200 Hillis Street, Youngwood, Pennsylvania 15697-1800 (412) 925-7272
 Powerex, Europe, S.A. 428 Avenue G. Durand, BP107, 72003 Le Mans, France (43) 41.14.14

C390_X555
 Phase Control SCR
 590 Amperes Average, 1200 Volts

Absolute Maximum Ratings

	Symbol	C390_X555	Units
RMS On-State Current @ $T_C = 80^\circ\text{C}$	$I_{T(RMS)}$	925	Amperes
Average On-State Current @ $T_C = 80^\circ\text{C}$	$I_{T(av)}$	590	Amperes
Peak One-Cycle Surge (Non-Repetitive) On-State Current (60Hz)	I_{TSM}	8000	Amperes
Peak One-Cycle Surge (Non-Repetitive) On-State Current (50Hz)	I_{TSM}	7600	Amperes
Critical Rate-of-Rise of On-State Current (Non-Repetitive)	di/dt	800	Amperes/ μs
Critical Rate-of-Rise of On-State Current (Repetitive)	di/dt	500	Amperes/ μs
I^2t (for Fusing), One Cycle at 60Hz	I^2t	266,500	A^2sec
Peak Gate Power Dissipation	P_{GM}	200	Watts
Average Gate Power Dissipation	$P_{G(av)}$	5	Watts
Storage Temperature	T_{STG}	-40 to 150	$^\circ\text{C}$
Operating Temperature	T_J	-40 to 150	$^\circ\text{C}$
Mounting Force		1800 to 2200	lb.
Mounting Force		8 to 9.8	kN

Electrical and Thermal Characteristics

Characteristics	Symbol	Test Conditions	C390_X555	Units
Voltage—Blocking State Maximums				
Forward Leakage, Peak	I_{DRM}	$T_J = 150^\circ\text{C}$, rated V_{DRM}	65	mA
Reverse Leakage, Peak	I_{RRM}	$T_J = 150^\circ\text{C}$, rated V_{RRM}	65	mA
Current—Conducting State Maximums				
Peak On-State Voltage	V_{TM}	$I_{TM} = 3000\text{A}$, $T_J = 25^\circ\text{C}$	2.6	Volts
Switching				
Typical Turn-Off Time	t_q	$T_J = 150^\circ\text{C}$; $I_{TM} = 50$ Amps; $V_R = 50$ Volts Min.; V_{DRM} (Reapplied); Rate-of-Rise of Reapplied Off-State Voltage = $20\text{V}/\mu\text{sec}$ (linear); Commutation $di/dt = 25$ Amps/ μsec ; Repetition Rate = 1 pps; Gate Bias During Turn-Off Interval = 0 Volts, 100Ω	200	μsec
Min. Critical dv/dt exponential to V_{DRM}	dv/dt	$T_J = 150^\circ\text{C}$, Gate Open	200	$\text{V}/\mu\text{sec}$
Thermal				
Maximum Thermal Resistance, double sided cooling				
Junction to Case	$R_{\theta JC}$		0.06	$^\circ\text{C}/\text{Watt}$
Case to Sink, Lubricated	$R_{\theta CS}$		0.02	$^\circ\text{C}/\text{Watt}$
Gate—Maximum Parameters				
Gate Current to Trigger	I_{GT}	$T_J = 25^\circ\text{C}$, $V_D = 6\text{Vdc}$, $R_L = 3\Omega$	150	mA
Gate Voltage to Trigger	V_{GT}	$T_J = -40^\circ\text{C}$ to 150°C , $V_D = 6\text{Vdc}$, $R_L = 3\Omega$	5	Volts
Non-Triggering Gate Voltage	V_{GDM}	$T_J = 150^\circ\text{C}$, $V_D = \text{Rated } V_{DRM}$, $R_L = 1000\Omega$	0.15	Volts
Peak Forward Gate Current	I_{GTM}		10	Amperes
Peak Reverse Gate Voltage	V_{GRM}		5	Volts

Powerex, Inc., 200 Hillis Street, Youngwood, Pennsylvania 15697-1800 (412) 925-7272
 Powerex, Europe, S.A. 428 Avenue G. Durand, BP107, 72003 Le Mans, France (43) 41.14.14

C390_X555
 Phase Control SCR
 590 Amperes Average, 1200 Volts

MAXIMUM ON-STATE CHARACTERISTICS

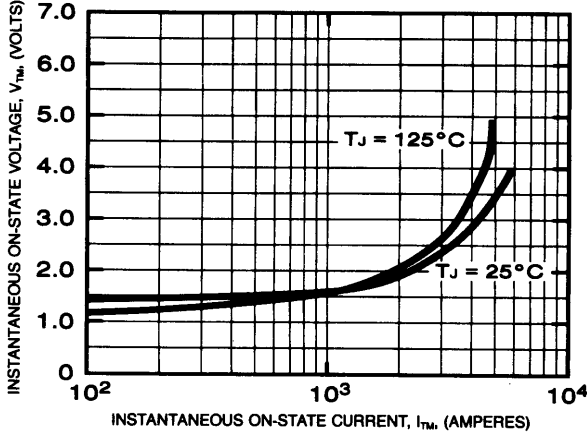

TRANSIENT THERMAL IMPEDANCE CHARACTERISTICS (JUNCTION TO CASE)

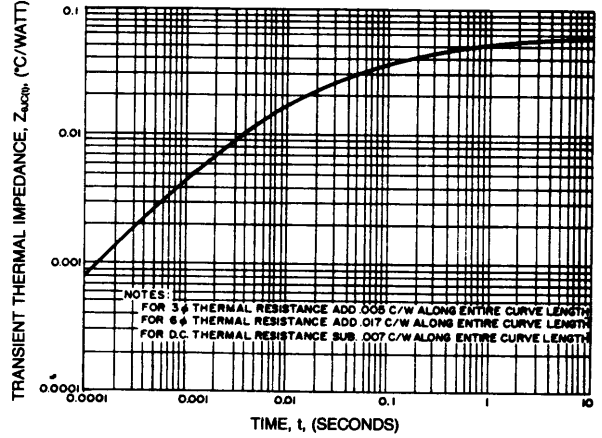

MAXIMUM ALLOWABLE CASE TEMPERATURE (SINUSOIDAL WAVEFORM)

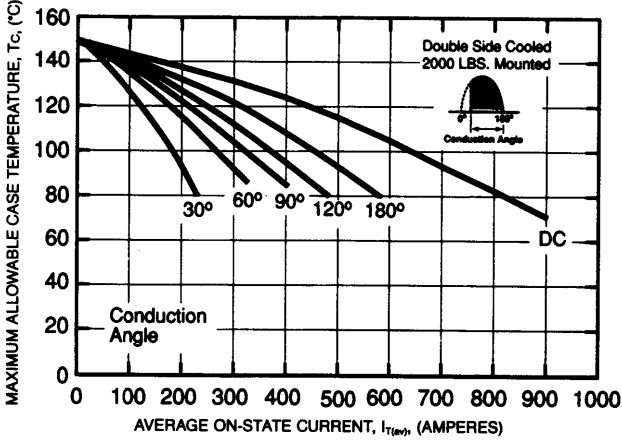

MAXIMUM ON-STATE POWER DISSIPATION (SINUSOIDAL WAVEFORM)

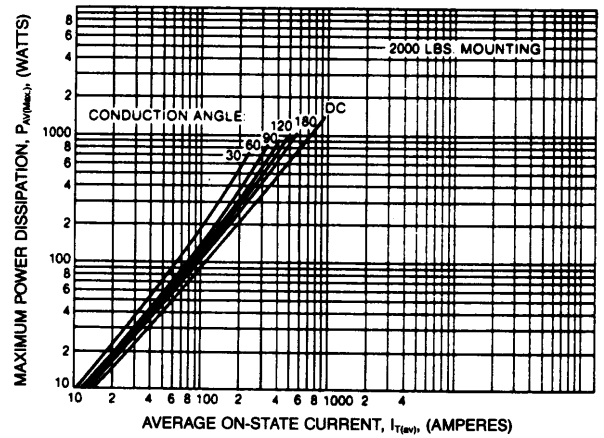

MAXIMUM ALLOWABLE CASE TEMPERATURE (RECTANGULAR WAVEFORM)

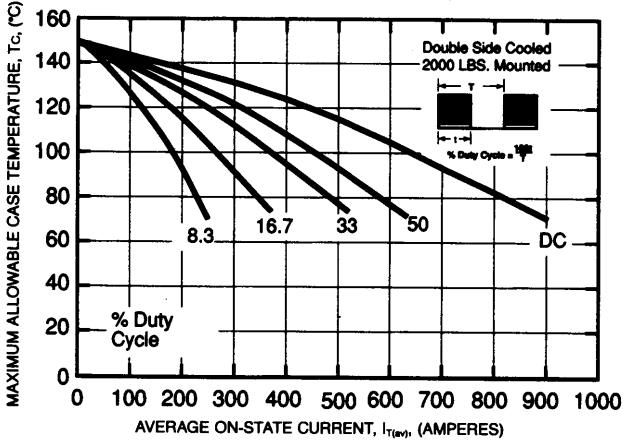

MAXIMUM ON-STATE POWER DISSIPATION (RECTANGULAR WAVEFORM)

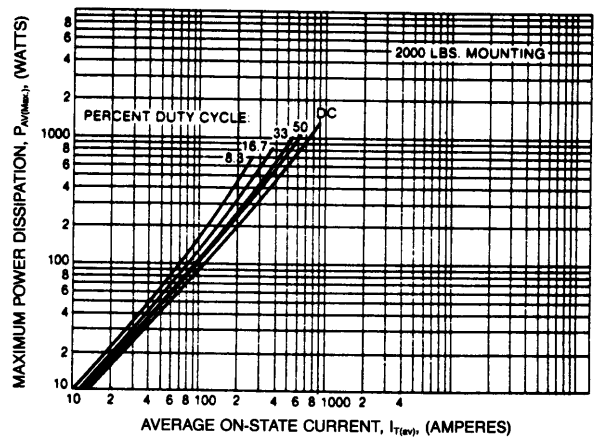

Powerex, Inc., 200 Hillis Street, Youngwood, Pennsylvania 15697-1800 (412) 925-7272
 Powerex, Europe, S.A. 428 Avenue G. Durand, BP107, 72003 Le Mans, France (43) 41.14.14

C390_X555

Phase Control SCR

590 Amperes Average, 1200 Volts

MAXIMUM ALLOWABLE CASE TEMPERATURE
(SINUSOIDAL WAVEFORM)

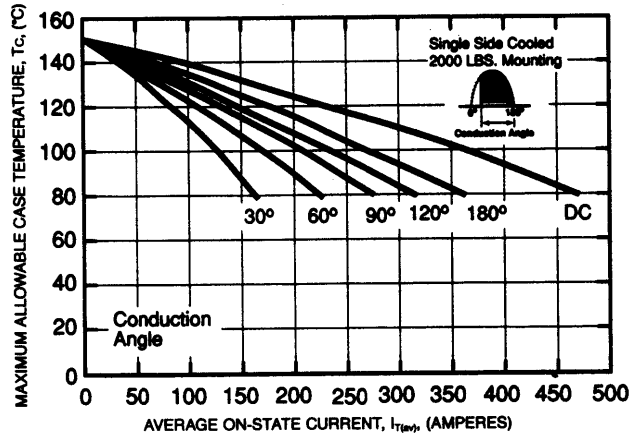

MAXIMUM ALLOWABLE CASE TEMPERATURE
(RECTANGULAR WAVEFORM)

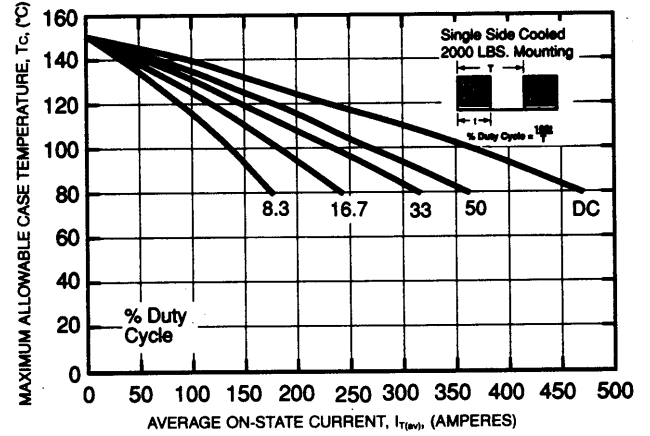



LittleDiode supplies new, hard to find or obsolete electronic components and semiconductors all over the world.

With over two million different components listed you are sure to find the part you need.

Feel free to visit us today at our online store:

LittleDiode.com

Looking forward to providing you with the best possible service.