

1 - Cathode  
2 - Anode  
Back of Case - Cathode

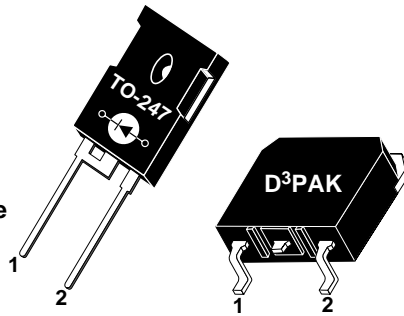

**APT60D100B 1000V 60A**  
**APT60D100S 1000V 60A**

## ULTRAFAST SOFT RECOVERY RECTIFIER DIODE

PRODUCT APPLICATIONS	PRODUCT FEATURES	PRODUCT BENEFITS
<ul style="list-style-type: none"> <li>• Anti-Parallel Diode               <ul style="list-style-type: none"> <li>-Switchmode Power Supply</li> <li>-Inverters</li> </ul> </li> <li>• Free Wheeling Diode               <ul style="list-style-type: none"> <li>-Motor Controllers</li> <li>-Converters</li> </ul> </li> <li>• Snubber Diode</li> <li>• Uninterruptible Power Supply (UPS)</li> <li>• Induction Heating</li> <li>• High Speed Rectifiers</li> </ul>	<ul style="list-style-type: none"> <li>• Ultrafast Recovery Times</li> <li>• Soft Recovery Characteristics</li> <li>• Popular TO-247 Package or Surface Mount D<sup>3</sup>PAK Package</li> <li>• Low Forward Voltage</li> <li>• High Blocking Voltage</li> <li>• Low Leakage Current</li> </ul>	<ul style="list-style-type: none"> <li>• Low Losses</li> <li>• Low Noise Switching</li> <li>• Cooler Operation</li> <li>• Higher Reliability Systems</li> <li>• Increased System Power Density</li> </ul>

### MAXIMUM RATINGS

All Ratings:  $T_C = 25^\circ\text{C}$  unless otherwise specified.

Symbol	Characteristic / Test Conditions	APT60D100B_S	UNIT
$V_R$	Maximum D.C. Reverse Voltage	1000	Volts
$V_{RRM}$	Maximum Peak Repetitive Reverse Voltage		
$V_{RWM}$	Maximum Working Peak Reverse Voltage		
$I_F(AV)$	Maximum Average Forward Current ( $T_C = 117^\circ\text{C}$ , Duty Cycle = 0.5)	60	Amps
$I_F(RMS)$	RMS Forward Current (Square wave, 50% duty)	136	
$I_{FSM}$	Non-Repetitive Forward Surge Current ( $T_J = 45^\circ\text{C}$ , 8.3ms)	540	
$T_J, T_{STG}$	Operating and Storage Temperature Range	-55 to 150	$^\circ\text{C}$
$T_L$	Lead Temperature for 10 Sec.	300	

### STATIC ELECTRICAL CHARACTERISTICS

Symbol		MIN	TYP	MAX	UNIT
$V_F$	Forward Voltage	$I_F = 60\text{A}$	1.9	2.5	Volts
		$I_F = 120\text{A}$	2.2		
		$I_F = 60\text{A}, T_J = 125^\circ\text{C}$	1.7		
$I_{RM}$	Maximum Reverse Leakage Current	$V_R = V_R$ Rated		250	$\mu\text{A}$
		$V_R = V_R$ Rated, $T_J = 125^\circ\text{C}$		500	
$C_T$	Junction Capacitance, $V_R = 200\text{V}$		65		pF

Symbol	Characteristic	Test Conditions	MIN	TYP	MAX	UNIT
$t_{rr}$	Reverse Recovery Time	$I_F = 1A, di_F/dt = -100A/\mu s, V_R = 30V, T_J = 25^\circ C$	-	34		ns
$t_{rr}$	Reverse Recovery Time		-	280		
$Q_{rr}$	Reverse Recovery Charge	$I_F = 60A, di_F/dt = -200A/\mu s, V_R = 667V, T_C = 25^\circ C$	-	760		nC
$I_{RRM}$	Maximum Reverse Recovery Current		-	6	-	Amps
$t_{rr}$	Reverse Recovery Time		-	350		ns
$Q_{rr}$	Reverse Recovery Charge	$I_F = 60A, di_F/dt = -200A/\mu s, V_R = 667V, T_C = 125^\circ C$	-	3600		nC
$I_{RRM}$	Maximum Reverse Recovery Current		-	16	-	Amps
$t_{rr}$	Reverse Recovery Time		-	170		ns
$Q_{rr}$	Reverse Recovery Charge	$I_F = 60A, di_F/dt = -1000A/\mu s, V_R = 667, T_C = 125^\circ C$	-	5650		nC
$I_{RRM}$	Maximum Reverse Recovery Current		-	50		Amps

THERMAL AND MECHANICAL CHARACTERISTICS

Symbol	Characteristic / Test Conditions	MIN	TYP	MAX	UNIT
$R_{\theta JC}$	Junction-to-Case Thermal Resistance			.21	°C/W
$R_{\theta JA}$	Junction-to-Ambient Thermal Resistance			40	
$W_T$	Package Weight		0.22		oz
			5.9		g
Torque	Maximum Mounting Torque			10	lb•in
				1.1	N•m

APT Reserves the right to change, without notice, the specifications and information contained herein.

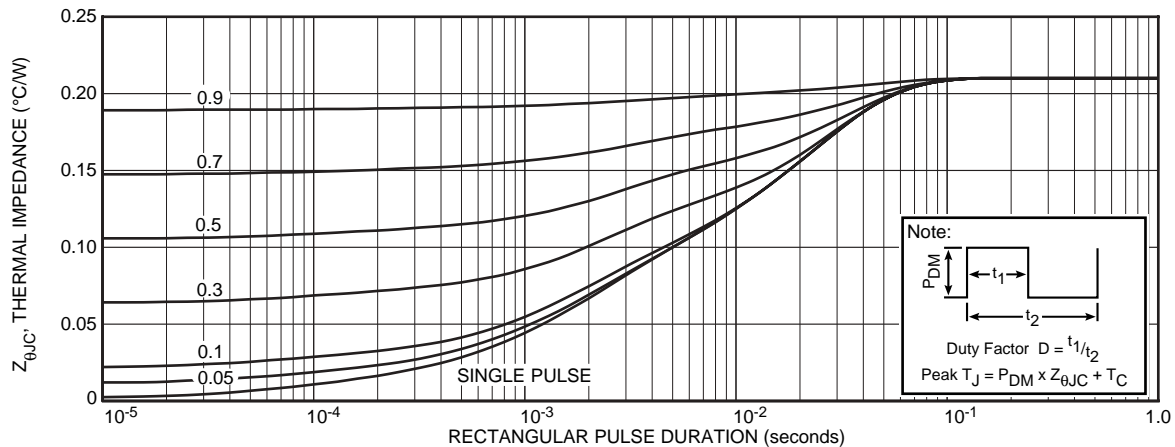

FIGURE 1a. MAXIMUM EFFECTIVE TRANSIENT THERMAL IMPEDANCE, JUNCTION-TO-CASE vs. PULSE DURATION

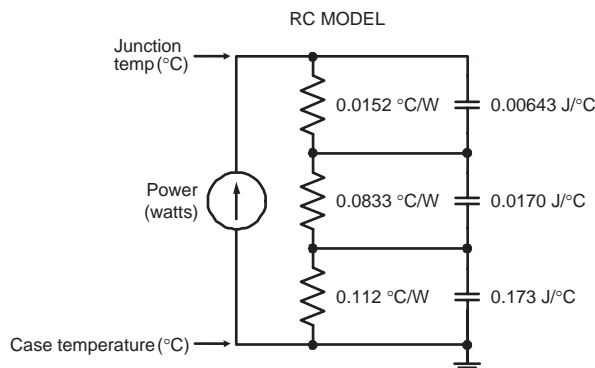

FIGURE 1b, TRANSIENT THERMAL IMPEDANCE MODEL

# TYPICAL PERFORMANCE CURVES

APT60D100B\_S

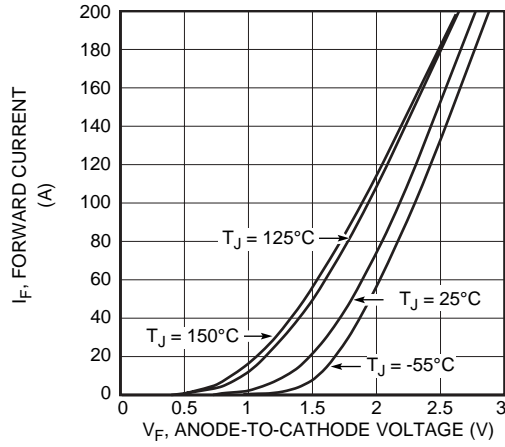

Figure 2. Forward Current vs. Forward Voltage

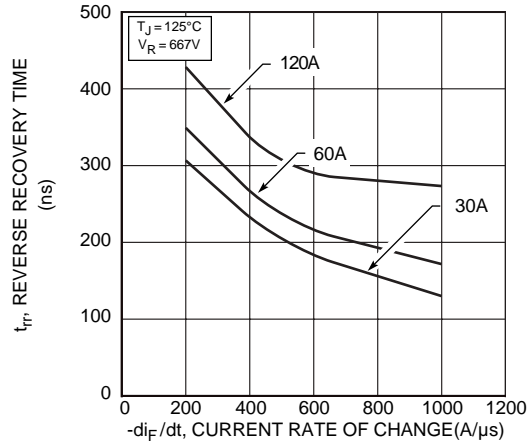

Figure 3. Reverse Recovery Time vs. Current Rate of Change

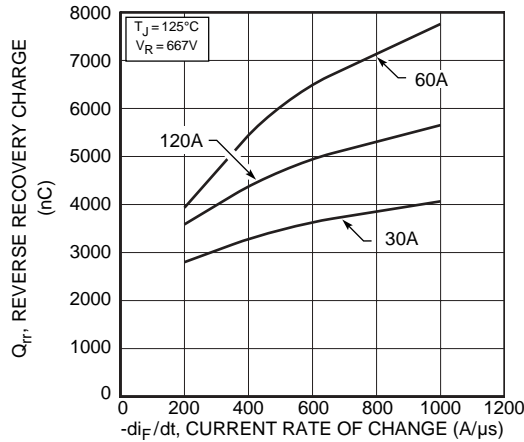

Figure 4. Reverse Recovery Charge vs. Current Rate of Change

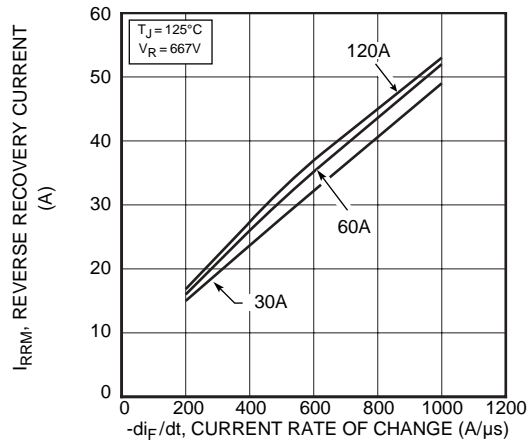

Figure 5. Reverse Recovery Current vs. Current Rate of Change

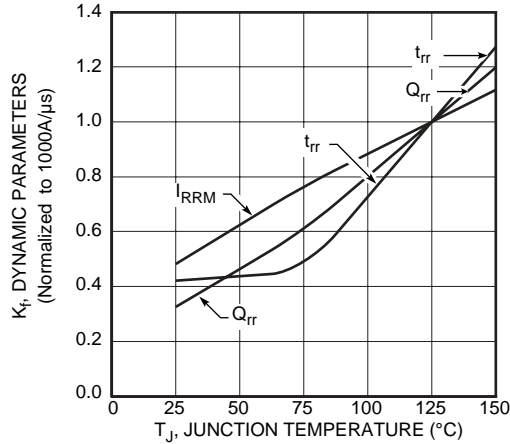

Figure 6. Dynamic Parameters vs. Junction Temperature

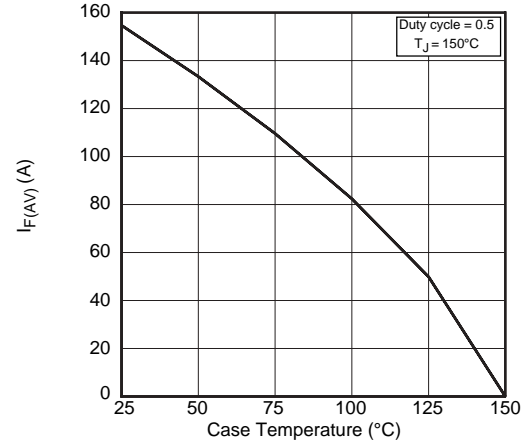

Figure 7. Maximum Average Forward Current vs. Case Temperature

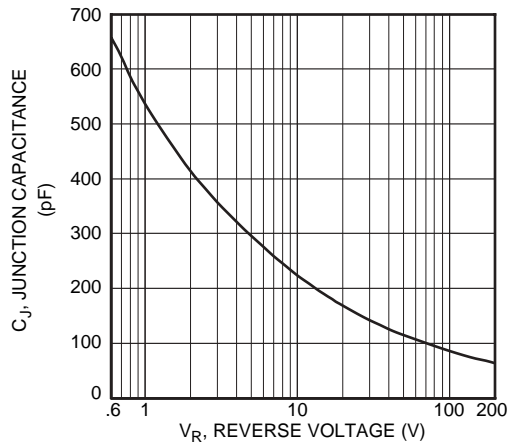

Figure 8. Junction Capacitance vs. Reverse Voltage

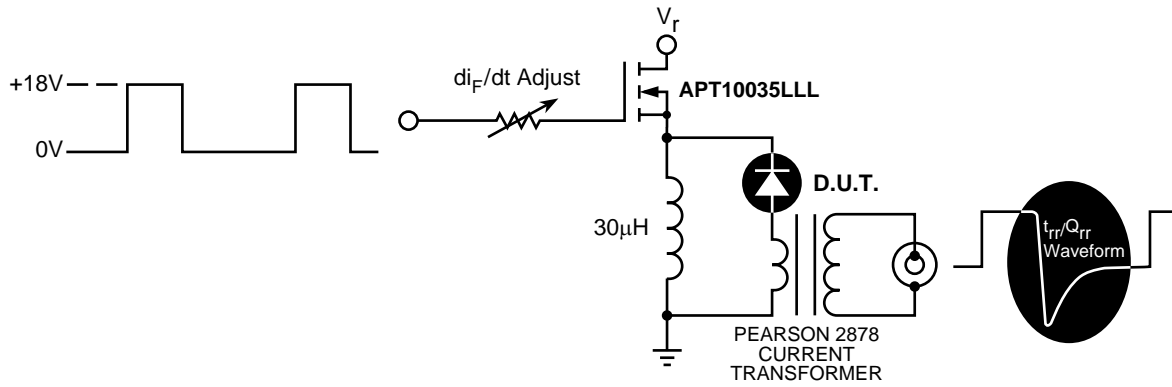

Figure 9. Diode Test Circuit

- 1  $I_F$  - Forward Conduction Current
- 2  $di_F/dt$  - Rate of Diode Current Change Through Zero Crossing.
- 3  $I_{RRM}$  - Maximum Reverse Recovery Current.
- 4  $t_{rr}$  - Reverse Recovery Time, measured from zero crossing where diode current goes from positive to negative, to the point at which the straight line through  $I_{RRM}$  and  $0.25 \cdot I_{RRM}$  passes through zero.
- 5  $Q_{rr}$  - Area Under the Curve Defined by  $I_{RRM}$  and  $t_{rr}$ .

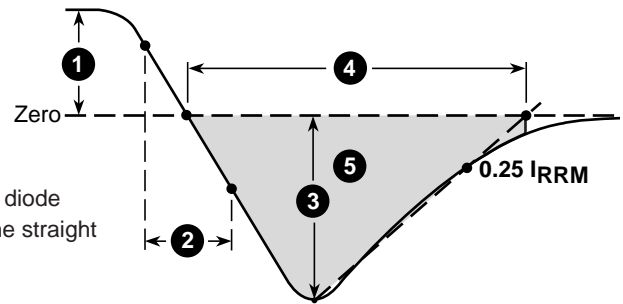
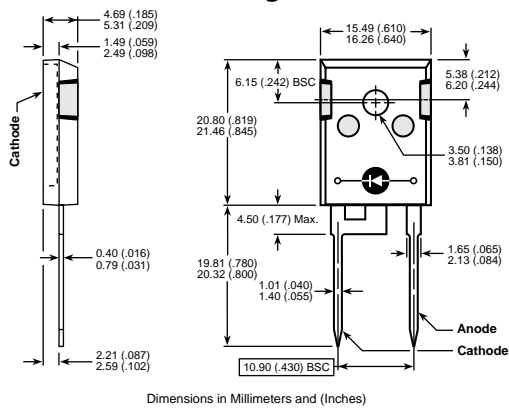
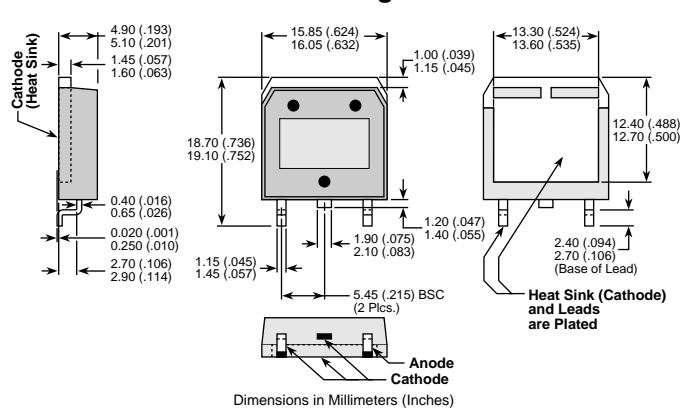

Figure 10, Diode Reverse Recovery Waveform and Definitions

TO-247 Package Outline



D<sup>3</sup>PAK Package Outline



053-0001 Rev E 1-2004



LittleDiode supplies new, hard to find or obsolete electronic components and semiconductors all over the world.

With over two million different components listed you are sure to find the part you need.

Feel free to visit us today at our online store:

[LittleDiode.com](http://LittleDiode.com)

Looking forward to providing you with the best possible service.