

# PHEMT GaAs IC Transmit/Dual Receive Switch With Diversity Antennas 0.5–2 GHz



AS160-86

## Features

- Five RF Ports
- Transmit to Either of Two Antennas
- Receive From Either of Two Antennas
- Differential Biasing for High Linearity

## Description

The AS160-86 is a PHEMT GaAs IC transfer and SPDT switch. This switch is ideal for dual band applications where  $T_X/R_X$  diversity is required. The switch has 4 control lines that may be positive, negative or a combination of both (differential biasing). This switch is designed for commercial wireless applications such as GSM, DCS and PCS systems.

## MSOP-10

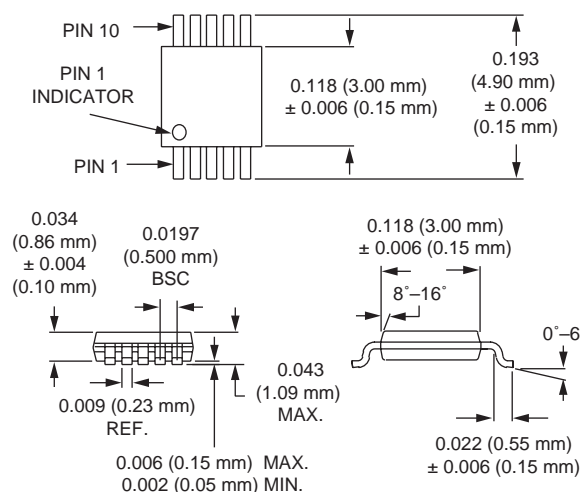

## Electrical Specifications at 25°C (+2.75, -4.5 V)

Parameter <sup>1</sup>	Condition	Frequency	Min.	Typ.	Max.	Unit
Insertion Loss <sup>2</sup>	$T_X$ -Ant. 1, Ant. 2	0.5–1.0 GHz		0.5	0.6	dB
		1.0–2.0 GHz		0.7	0.9	dB
	$R_{X1}$ , $R_{X2}$ -Ant. 1, Ant. 2	0.5–1.0 GHz		1.1	1.3	dB
		1.0–2.0 GHz		1.5	1.7	dB
Isolation	$R_{X1}$ , $R_{X2}$ -Ant. 1, Ant. 2 ( $T_X$ -Ant. 1, 2 Insertion Loss)	0.5–1.0 GHz		35	30	dB
		1.0–2.0 GHz		25	20	dB
VSWR	Insertion Loss States	0.5–2.0 GHz		1.5:1		

## Operating Characteristics at 25°C (+2.75, -4.5 V)

Parameter <sup>1</sup>	Condition	Frequency	Min.	Typ.	Max.	Unit
Switching Characteristics	Rise, Fall (10/90% or 90%/10% RF)			50		nS
	On, Off (50% CTL to 90%/10% RF)			100		nS
	Video Feedthru			50		mV
2nd and 3rd Harmonics	34.5 dBm @ $(V_{High} - V_{Low}) > 7.25$	0.9 GHz		65		dBc
	32.0 dBm @ $(V_{High} - V_{Low}) > 7.25$	1.8 GHz		67		dBc
Control Voltages	$V_{Low} = -5 < V_{Low} < -2.75$ V @ 200 $\mu$ A Max. $V_{High} = -.2 < V_{High} < +5$ V @ 200 $\mu$ A Max. Differential = $2.75 < (V_{High} - V_{Low}) < 10$ V @ 200 $\mu$ A Max.					

1. All measurements made in a 50  $\Omega$  system, unless otherwise specified.

2. Insertion loss changes by 0.003 dB/°C.

Typical Performance Data

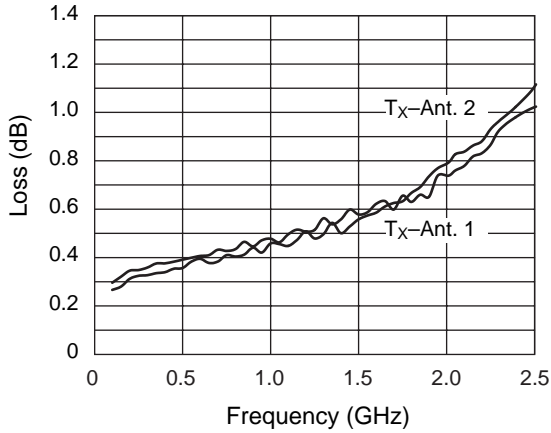

**TX-Ant. 1, TX-Ant. 2  
Insertion Loss vs. Frequency**

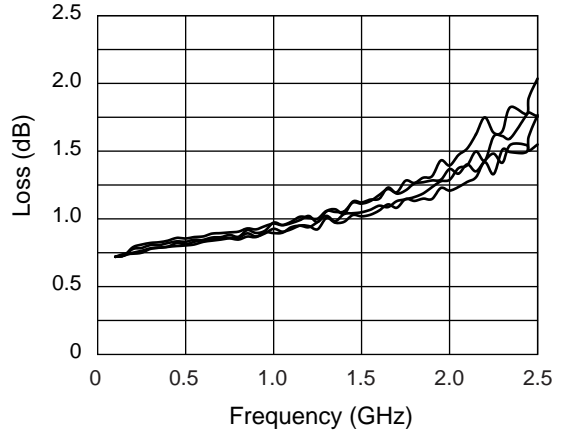

**RX1-Ant. 1, 2 RX2-Ant. 1, 2  
Insertion Loss vs. Frequency**

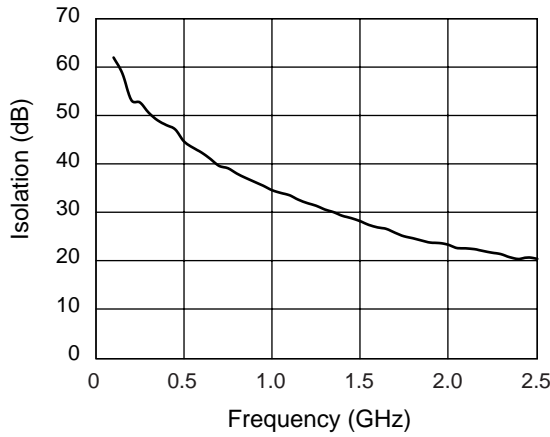

**Ant. 1, 2-RX1, 2  
Isolation vs. Frequency**

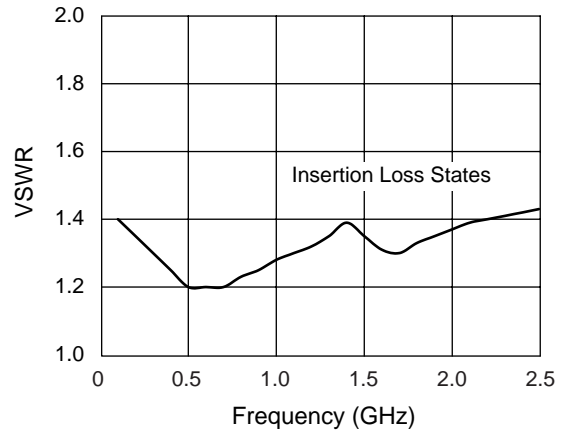

**VSWR vs. Frequency**

Truth Table

V <sub>1</sub>	V <sub>2</sub>	V <sub>3</sub>	V <sub>4</sub>	T <sub>X</sub> -Ant. 1	T <sub>X</sub> -Ant. 2	R <sub>X1</sub> -Ant. 1	R <sub>X1</sub> -Ant. 2	R <sub>X2</sub> -Ant. 1	R <sub>X2</sub> -Ant. 2
V <sub>Low</sub>	V <sub>High</sub>	V <sub>Low</sub>	V <sub>Low</sub>	Ins. Loss	Isol.	Isol.	Isol.	Isol.	Isol.
V <sub>High</sub>	V <sub>Low</sub>	V <sub>Low</sub>	V <sub>Low</sub>	Isol.	Ins. Loss	Isol.	Isol.	Isol.	Isol.
V <sub>High</sub>	V <sub>Low</sub>	V <sub>High</sub>	V <sub>Low</sub>	Isol.	Ins. Loss	Ins. Loss	Isol.	Isol.	Isol.
V <sub>Low</sub>	V <sub>High</sub>	V <sub>High</sub>	V <sub>Low</sub>	Ins. Loss	Isol.	Isol.	Ins. Loss	Isol.	Isol.
V <sub>High</sub>	V <sub>Low</sub>	V <sub>Low</sub>	V <sub>High</sub>	Isol.	Ins. Loss	Isol.	Isol.	Ins. Loss	Isol.
V <sub>Low</sub>	V <sub>High</sub>	V <sub>Low</sub>	V <sub>High</sub>	Ins. Loss	Isol.	Isol.	Isol.	Isol.	Ins. Loss

V<sub>Low</sub> = -5 < V<sub>Low</sub> < -2.75 V @ 200 μA Max.

V<sub>High</sub> = -.2 < V<sub>High</sub> < +5 V @ 200 μA Max.

Differential = 2.75 < (V<sub>High</sub> - V<sub>Low</sub>) < 10 V @ 200 μA Max.

Absolute Maximum Ratings

Characteristic	Value
RF Input Power	3 W Max. > 500 MHz +5 V/-5 V
Control Voltage	+5 V/-5 V
Operating Temperature	-40°C to +85°C
Storage Temperature	-65°C to +150°C
θ <sub>JC</sub>	25°C/W

Note: Exceeding these ratings may cause irreversible damage.

Switch Schematic

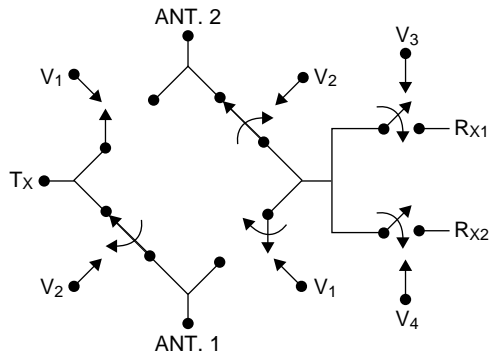

Pin Out

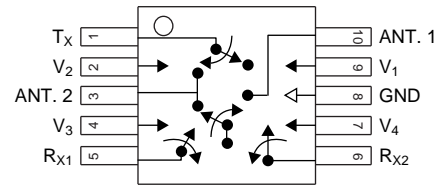



LittleDiode supplies new, hard to find or obsolete electronic components and semiconductors all over the world.

With over two million different components listed you are sure to find the part you need.

Feel free to visit us today at our online store:

[LittleDiode.com](http://LittleDiode.com)

Looking forward to providing you with the best possible service.