

Features

- High-performance, Low-power AVR[®] 8-bit Microcontroller
- Advanced RISC Architecture
 - 133 Powerful Instructions – Most Single Clock Cycle Execution
 - 32 x 8 General Purpose Working Registers + Peripheral Control Registers
 - Fully Static Operation
 - Up to 16 MIPS Throughput at 16 MHz
 - On-chip 2-cycle Multiplier
- Nonvolatile Program and Data Memories
 - 128K Bytes of In-System Reprogrammable Flash
 - Endurance: 10,000 Write/Erase Cycles
 - Optional Boot Code Section with Independent Lock Bits
 - In-System Programming by On-chip Boot Program
 - True Read-While-Write Operation
 - 4K Bytes EEPROM
 - Endurance: 100,000 Write/Erase Cycles
 - 4K Bytes Internal SRAM
 - Up to 64K Bytes Optional External Memory Space
 - Programming Lock for Software Security
 - SPI Interface for In-System Programming
- JTAG (IEEE std. 1149.1 Compliant) Interface
 - Boundary-scan Capabilities According to the JTAG Standard
 - Extensive On-chip Debug Support
 - Programming of Flash, EEPROM, Fuses and Lock Bits through the JTAG Interface
- Peripheral Features
 - Two 8-bit Timer/Counters with Separate Prescalers and Compare Modes
 - Two Expanded 16-bit Timer/Counters with Separate Prescaler, Compare Mode and Capture Mode
 - Real Time Counter with Separate Oscillator
 - Two 8-bit PWM Channels
 - 6 PWM Channels with Programmable Resolution from 2 to 16 Bits
 - Output Compare Modulator
 - 8-channel, 10-bit ADC
 - 8 Single-ended Channels
 - 7 Differential Channels
 - 2 Differential Channels with Programmable Gain at 1x, 10x, or 200x
 - Byte-oriented Two-wire Serial Interface
 - Dual Programmable Serial USARTs
 - Master/Slave SPI Serial Interface
 - Programmable Watchdog Timer with On-chip Oscillator
 - On-chip Analog Comparator
- Special Microcontroller Features
 - Power-on Reset and Programmable Brown-out Detection
 - Internal Calibrated RC Oscillator
 - External and Internal Interrupt Sources
 - Six Sleep Modes: Idle, ADC Noise Reduction, Power-save, Power-down, Standby, and Extended Standby
 - Software Selectable Clock Frequency
 - ATmega103 Compatibility Mode Selected by a Fuse
 - Global Pull-up Disable
- I/O and Packages
 - 53 Programmable I/O Lines
 - 64-lead TQFP and 64-pad MLF
- Operating Voltages
 - 2.7 - 5.5V for ATmega128L
 - 4.5 - 5.5V for ATmega128
- Speed Grades
 - 0 - 8 MHz for ATmega128L
 - 0 - 16 MHz for ATmega128



8-bit AVR[®]
Microcontroller
with 128K Bytes
In-System
Programmable
Flash

ATmega128
ATmega128L

Preliminary

Rev. 2467J-AVR-12/03



Pin Configurations

Figure 1. Pinout ATmega128

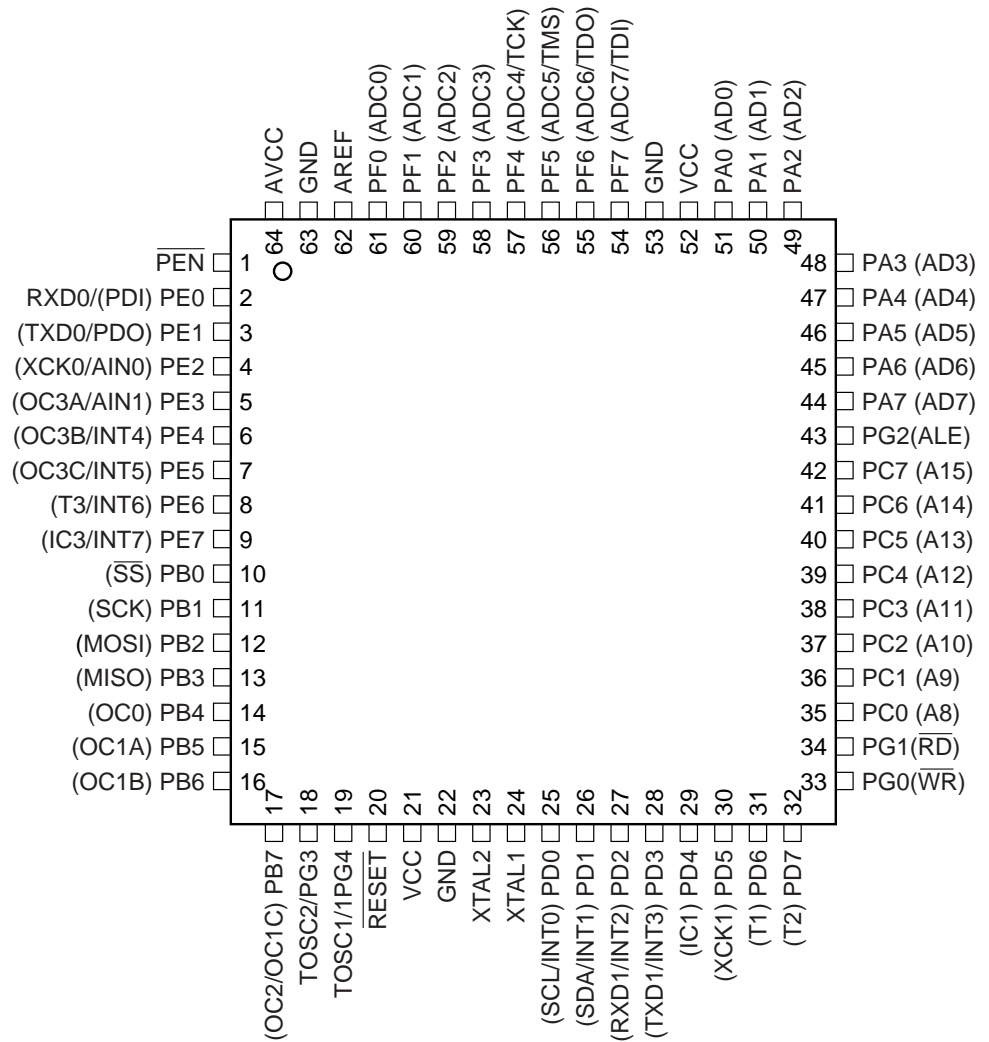

Overview

The ATmega128 is a low-power CMOS 8-bit microcontroller based on the AVR enhanced RISC architecture. By executing powerful instructions in a single clock cycle, the ATmega128 achieves throughputs approaching 1 MIPS per MHz allowing the system designer to optimize power consumption versus processing speed.

Block Diagram

Figure 2. Block Diagram

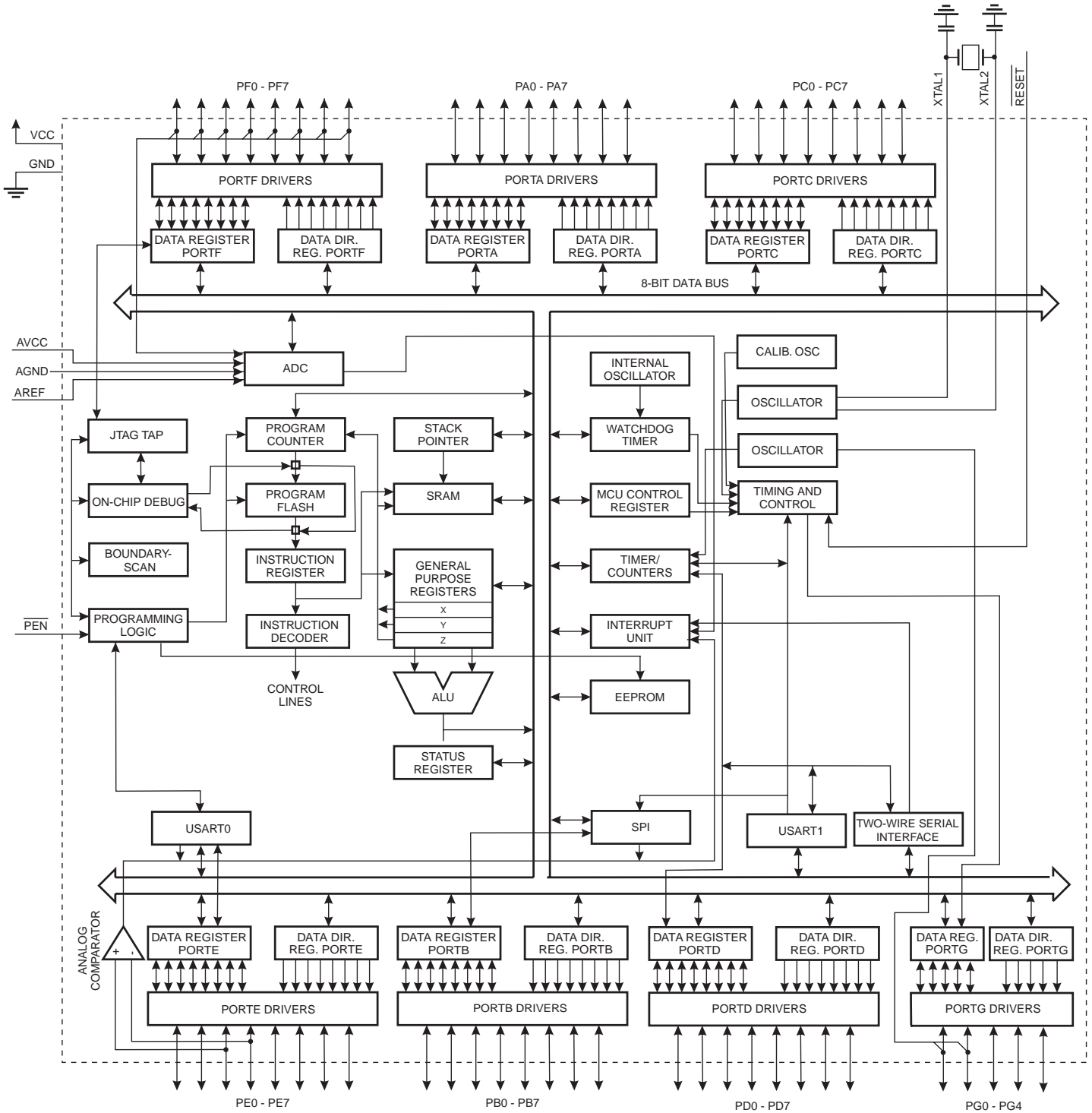



The AVR core combines a rich instruction set with 32 general purpose working registers. All the 32 registers are directly connected to the Arithmetic Logic Unit (ALU), allowing two independent registers to be accessed in one single instruction executed in one clock cycle. The resulting architecture is more code efficient while achieving throughputs up to ten times faster than conventional CISC microcontrollers.

The ATmega128 provides the following features: 128K bytes of In-System Programmable Flash with Read-While-Write capabilities, 4K bytes EEPROM, 4K bytes SRAM, 53 general purpose I/O lines, 32 general purpose working registers, Real Time Counter (RTC), four flexible Timer/Counters with compare modes and PWM, 2 USARTs, a byte oriented Two-wire Serial Interface, an 8-channel, 10-bit ADC with optional differential input stage with programmable gain, programmable Watchdog Timer with Internal Oscillator, an SPI serial port, IEEE std. 1149.1 compliant JTAG test interface, also used for accessing the On-chip Debug system and programming and six software selectable power saving modes. The Idle mode stops the CPU while allowing the SRAM, Timer/Counters, SPI port, and interrupt system to continue functioning. The Power-down mode saves the register contents but freezes the Oscillator, disabling all other chip functions until the next interrupt or Hardware Reset. In Power-save mode, the asynchronous timer continues to run, allowing the user to maintain a timer base while the rest of the device is sleeping. The ADC Noise Reduction mode stops the CPU and all I/O modules except Asynchronous Timer and ADC, to minimize switching noise during ADC conversions. In Standby mode, the Crystal/Resonator Oscillator is running while the rest of the device is sleeping. This allows very fast start-up combined with low power consumption. In Extended Standby mode, both the main Oscillator and the Asynchronous Timer continue to run.

The device is manufactured using Atmel's high-density nonvolatile memory technology. The On-chip ISP Flash allows the program memory to be reprogrammed in-system through an SPI serial interface, by a conventional nonvolatile memory programmer, or by an On-chip Boot program running on the AVR core. The boot program can use any interface to download the application program in the application Flash memory. Software in the Boot Flash section will continue to run while the Application Flash section is updated, providing true Read-While-Write operation. By combining an 8-bit RISC CPU with In-System Self-Programmable Flash on a monolithic chip, the Atmel ATmega128 is a powerful microcontroller that provides a highly flexible and cost effective solution to many embedded control applications.

The ATmega128 AVR is supported with a full suite of program and system development tools including: C compilers, macro assemblers, program debugger/simulators, in-circuit emulators, and evaluation kits.

ATmega103 and ATmega128 Compatibility

The ATmega128 is a highly complex microcontroller where the number of I/O locations supersedes the 64 I/O locations reserved in the AVR instruction set. To ensure backward compatibility with the ATmega103, all I/O locations present in ATmega103 have the same location in ATmega128. Most additional I/O locations are added in an Extended I/O space starting from \$60 to \$FF, (i.e., in the ATmega103 internal RAM space). These locations can be reached by using LD/LDS/LDD and ST/STS/STD instructions only, not by using IN and OUT instructions. The relocation of the internal RAM space may still be a problem for ATmega103 users. Also, the increased number of interrupt vectors might be a problem if the code uses absolute addresses. To solve these problems, an ATmega103 compatibility mode can be selected by programming the fuse M103C. In this mode, none of the functions in the Extended I/O space are in use, so the internal RAM is located as in ATmega103. Also, the Extended Interrupt vectors are removed.

The ATmega128 is 100% pin compatible with ATmega103, and can replace the ATmega103 on current Printed Circuit Boards. The application note “Replacing ATmega103 by ATmega128” describes what the user should be aware of replacing the ATmega103 by an ATmega128.

ATmega103 Compatibility Mode

By programming the M103C fuse, the ATmega128 will be compatible with the ATmega103 regards to RAM, I/O pins and interrupt vectors as described above. However, some new features in ATmega128 are not available in this compatibility mode, these features are listed below:

- One USART instead of two, Asynchronous mode only. Only the eight least significant bits of the Baud Rate Register is available.
- One 16 bits Timer/Counter with two compare registers instead of two 16-bit Timer/Counters with three compare registers.
- Two-wire serial interface is not supported.
- Port C is output only.
- Port G serves alternate functions only (not a general I/O port).
- Port F serves as digital input only in addition to analog input to the ADC.
- Boot Loader capabilities is not supported.
- It is not possible to adjust the frequency of the internal calibrated RC Oscillator.
- The External Memory Interface can not release any Address pins for general I/O, neither configure different wait-states to different External Memory Address sections.

In addition, there are some other minor differences to make it more compatible to ATmega103:

- Only EXTRF and PORF exists in MCUCSR.
- Timed sequence not required for Watchdog Time-out change.
- External Interrupt pins 3 - 0 serve as level interrupt only.
- USART has no FIFO buffer, so data overrun comes earlier.

Unused I/O bits in ATmega103 should be written to 0 to ensure same operation in ATmega128.

Pin Descriptions

VCC	Digital supply voltage.
GND	Ground.
Port A (PA7..PA0)	<p>Port A is an 8-bit bi-directional I/O port with internal pull-up resistors (selected for each bit). The Port A output buffers have symmetrical drive characteristics with both high sink and source capability. As inputs, Port A pins that are externally pulled low will source current if the pull-up resistors are activated. The Port A pins are tri-stated when a reset condition becomes active, even if the clock is not running.</p> <p>Port A also serves the functions of various special features of the ATmega128 as listed on page 69.</p>
Port B (PB7..PB0)	<p>Port B is an 8-bit bi-directional I/O port with internal pull-up resistors (selected for each bit). The Port B output buffers have symmetrical drive characteristics with both high sink and source capability. As inputs, Port B pins that are externally pulled low will source</p>



current if the pull-up resistors are activated. The Port B pins are tri-stated when a reset condition becomes active, even if the clock is not running.

Port B also serves the functions of various special features of the ATmega128 as listed on page 70.

Port C (PC7..PC0)

Port C is an 8-bit bi-directional I/O port with internal pull-up resistors (selected for each bit). The Port C output buffers have symmetrical drive characteristics with both high sink and source capability. As inputs, Port C pins that are externally pulled low will source current if the pull-up resistors are activated. The Port C pins are tri-stated when a reset condition becomes active, even if the clock is not running.

Port C also serves the functions of special features of the ATmega128 as listed on page 73. In ATmega103 compatibility mode, Port C is output only, and the port C pins are **not** tri-stated when a reset condition becomes active.

Port D (PD7..PD0)

Port D is an 8-bit bi-directional I/O port with internal pull-up resistors (selected for each bit). The Port D output buffers have symmetrical drive characteristics with both high sink and source capability. As inputs, Port D pins that are externally pulled low will source current if the pull-up resistors are activated. The Port D pins are tri-stated when a reset condition becomes active, even if the clock is not running.

Port D also serves the functions of various special features of the ATmega128 as listed on page 74.

Port E (PE7..PE0)

Port E is an 8-bit bi-directional I/O port with internal pull-up resistors (selected for each bit). The Port E output buffers have symmetrical drive characteristics with both high sink and source capability. As inputs, Port E pins that are externally pulled low will source current if the pull-up resistors are activated. The Port E pins are tri-stated when a reset condition becomes active, even if the clock is not running.

Port E also serves the functions of various special features of the ATmega128 as listed on page 77.

Port F (PF7..PF0)

Port F serves as the analog inputs to the A/D Converter.

Port F also serves as an 8-bit bi-directional I/O port, if the A/D Converter is not used. Port pins can provide internal pull-up resistors (selected for each bit). The Port F output buffers have symmetrical drive characteristics with both high sink and source capability. As inputs, Port F pins that are externally pulled low will source current if the pull-up resistors are activated. The Port F pins are tri-stated when a reset condition becomes active, even if the clock is not running. If the JTAG interface is enabled, the pull-up resistors on pins PF7(TDI), PF5(TMS), and PF4(TCK) will be activated even if a Reset occurs.

The TDO pin is tri-stated unless TAP states that shift out data are entered.

Port F also serves the functions of the JTAG interface.

In ATmega103 compatibility mode, Port F is an input Port only.

Port G (PG4..PG0)

Port G is a 5-bit bi-directional I/O port with internal pull-up resistors (selected for each bit). The Port G output buffers have symmetrical drive characteristics with both high sink and source capability. As inputs, Port G pins that are externally pulled low will source current if the pull-up resistors are activated. The Port G pins are tri-stated when a reset condition becomes active, even if the clock is not running.

Port G also serves the functions of various special features.

The port G pins are tri-stated when a reset condition becomes active, even if the clock is not running.

In ATmega103 compatibility mode, these pins only serves as strobes signals to the external memory as well as input to the 32 kHz Oscillator, and the pins are initialized to PG0 = 1, PG1 = 1, and PG2 = 0 asynchronously when a reset condition becomes active, even if the clock is not running. PG3 and PG4 are oscillator pins.

RESET

Reset input. A low level on this pin for longer than the minimum pulse length will generate a reset, even if the clock is not running. The minimum pulse length is given in Table 19 on page 48. Shorter pulses are not guaranteed to generate a reset.

XTAL1

Input to the inverting Oscillator amplifier and input to the internal clock operating circuit.

XTAL2

Output from the inverting Oscillator amplifier.

AVCC

AVCC is the supply voltage pin for Port F and the A/D Converter. It should be externally connected to V_{CC} , even if the ADC is not used. If the ADC is used, it should be connected to V_{CC} through a low-pass filter.

AREF

AREF is the analog reference pin for the A/D Converter.

PEN

PEN is a programming enable pin for the SPI Serial Programming mode. By holding this pin low during a Power-on Reset, the device will enter the SPI Serial Programming mode. PEN has no function during normal operation.



Register Summary

Address	Name	Bit 7	Bit 6	Bit 5	Bit 4	Bit 3	Bit 2	Bit 1	Bit 0	Page	
(\$FF)	Reserved	–	–	–	–	–	–	–	–		
..	Reserved	–	–	–	–	–	–	–	–		
(\$9E)	Reserved	–	–	–	–	–	–	–	–		
(\$9D)	UCSR1C	–	UMSEL1	UPM11	UPM10	USBS1	UCSZ11	UCSZ10	UCPOL1	190	
(\$9C)	UDR1	USART1 I/O Data Register									188
(\$9B)	UCSR1A	RXC1	TXC1	UDRE1	FE1	DOR1	UPE1	U2X1	MPCM1	188	
(\$9A)	UCSR1B	RXCIE1	TXCIE1	UDRIE1	RXEN1	TXEN1	UCSZ12	RXB81	TXB81	189	
(\$99)	UBRR1L	USART1 Baud Rate Register Low									192
(\$98)	UBRR1H	–	–	–	–	USART1 Baud Rate Register High				192	
(\$97)	Reserved	–	–	–	–	–	–	–	–		
(\$96)	Reserved	–	–	–	–	–	–	–	–		
(\$95)	UCSR0C	–	UMSEL0	UPM01	UPM00	USBS0	UCSZ01	UCSZ00	UCPOL0	190	
(\$94)	Reserved	–	–	–	–	–	–	–	–		
(\$93)	Reserved	–	–	–	–	–	–	–	–		
(\$92)	Reserved	–	–	–	–	–	–	–	–		
(\$91)	Reserved	–	–	–	–	–	–	–	–		
(\$90)	UBRR0H	–	–	–	–	USART0 Baud Rate Register High				192	
(\$8F)	Reserved	–	–	–	–	–	–	–	–		
(\$8E)	Reserved	–	–	–	–	–	–	–	–		
(\$8D)	Reserved	–	–	–	–	–	–	–	–		
(\$8C)	TCCR3C	FOC3A	FOC3B	FOC3C	–	–	–	–	–	135	
(\$8B)	TCCR3A	COM3A1	COM3A0	COM3B1	COM3B0	COM3C1	COM3C0	WGM31	WGM30	130	
(\$8A)	TCCR3B	ICNC3	ICES3	–	WGM33	WGM32	CS32	CS31	CS30	134	
(\$89)	TCNT3H	Timer/Counter3 – Counter Register High Byte									136
(\$88)	TCNT3L	Timer/Counter3 – Counter Register Low Byte									136
(\$87)	OCR3AH	Timer/Counter3 – Output Compare Register A High Byte									136
(\$86)	OCR3AL	Timer/Counter3 – Output Compare Register A Low Byte									136
(\$85)	OCR3BH	Timer/Counter3 – Output Compare Register B High Byte									137
(\$84)	OCR3BL	Timer/Counter3 – Output Compare Register B Low Byte									137
(\$83)	OCR3CH	Timer/Counter3 – Output Compare Register C High Byte									137
(\$82)	OCR3CL	Timer/Counter3 – Output Compare Register C Low Byte									137
(\$81)	ICR3H	Timer/Counter3 – Input Capture Register High Byte									137
(\$80)	ICR3L	Timer/Counter3 – Input Capture Register Low Byte									137
(\$7F)	Reserved	–	–	–	–	–	–	–	–		
(\$7E)	Reserved	–	–	–	–	–	–	–	–		
(\$7D)	ETIMSK	–	–	TICIE3	OCIE3A	OCIE3B	TOIE3	OCIE3C	OCIE1C	138	
(\$7C)	ETIFR	–	–	ICF3	OCF3A	OCF3B	TOV3	OCF3C	OCF1C	139	
(\$7B)	Reserved	–	–	–	–	–	–	–	–		
(\$7A)	TCCR1C	FOC1A	FOC1B	FOC1C	–	–	–	–	–	135	
(\$79)	OCR1CH	Timer/Counter1 – Output Compare Register C High Byte									136
(\$78)	OCR1CL	Timer/Counter1 – Output Compare Register C Low Byte									136
(\$77)	Reserved	–	–	–	–	–	–	–	–		
(\$76)	Reserved	–	–	–	–	–	–	–	–		
(\$75)	Reserved	–	–	–	–	–	–	–	–		
(\$74)	TWCR	TWINT	TWEA	TWSTA	TWSTO	TWWC	TWEN	–	TWIE	205	
(\$73)	TWDR	Two-wire Serial Interface Data Register									207
(\$72)	TWAR	TWA6	TWA5	TWA4	TWA3	TWA2	TWA1	TWA0	TWGCE	207	
(\$71)	TWSR	TWS7	TWS6	TWS5	TWS4	TWS3	–	TWPS1	TWPS0	206	
(\$70)	TWBR	Two-wire Serial Interface Bit Rate Register									205
(\$6F)	OSCCAL	Oscillator Calibration Register									39
(\$6E)	Reserved	–	–	–	–	–	–	–	–		
(\$6D)	XMCRA	–	SRL2	SRL1	SRL0	SRW01	SRW00	SRW11	–	29	
(\$6C)	XMCRB	XMBK	–	–	–	–	XMM2	XMM1	XMM0	31	
(\$6B)	Reserved	–	–	–	–	–	–	–	–		
(\$6A)	EICRA	ISC31	ISC30	ISC21	ISC20	ISC11	ISC10	ISC01	ISC00	86	
(\$69)	Reserved	–	–	–	–	–	–	–	–		
(\$68)	SPMCSR	SPMIE	RWWSB	–	RWWSRE	BLBSET	PGWRT	PGERS	SPMEN	279	
(\$67)	Reserved	–	–	–	–	–	–	–	–		
(\$66)	Reserved	–	–	–	–	–	–	–	–		
(\$65)	PORTG	–	–	–	PORTG4	PORTG3	PORTG2	PORTG1	PORTG0	85	
(\$64)	DDRG	–	–	–	DDG4	DDG3	DDG2	DDG1	DDG0	85	
(\$63)	PING	–	–	–	PING4	PING3	PING2	PING1	PING0	85	
(\$62)	PORTF	PORTF7	PORTF6	PORTF5	PORTF4	PORTF3	PORTF2	PORTF1	PORTF0	84	

Register Summary (Continued)

Address	Name	Bit 7	Bit 6	Bit 5	Bit 4	Bit 3	Bit 2	Bit 1	Bit 0	Page
(\$61)	DDRF	DDF7	DDF6	DDF5	DDF4	DDF3	DDF2	DDF1	DDF0	85
(\$60)	Reserved	–	–	–	–	–	–	–	–	
\$3F (\$5F)	SREG	I	T	H	S	V	N	Z	C	9
\$3E (\$5E)	SPH	SP15	SP14	SP13	SP12	SP11	SP10	SP9	SP8	12
\$3D (\$5D)	SPL	SP7	SP6	SP5	SP4	SP3	SP2	SP1	SP0	12
\$3C (\$5C)	XDIV	XDIVEN	XDIV6	XDIV5	XDIV4	XDIV3	XDIV2	XDIV1	XDIV0	41
\$3B (\$5B)	RAMPZ	–	–	–	–	–	–	–	RAMPZ0	12
\$3A (\$5A)	EICRB	ISC71	ISC70	ISC61	ISC60	ISC51	ISC50	ISC41	ISC40	87
\$39 (\$59)	EIMSK	INT7	INT6	INT5	INT4	INT3	INT2	INT1	INT0	88
\$38 (\$58)	EIFR	INTF7	INTF6	INTF5	INTF4	INTF3	INTF	INTF1	INTF0	88
\$37 (\$57)	TIMSK	OCIE2	TOIE2	TICIE1	OCIE1A	OCIE1B	TOIE1	OCIE0	TOIE0	105, 138, 158
\$36 (\$56)	TIFR	OCF2	TOV2	ICF1	OCF1A	OCF1B	TOV1	OCF0	TOV0	105, 139, 159
\$35 (\$55)	MCUCR	SRE	SRW10	SE	SM1	SM0	SM2	IVSEL	IVCE	29, 42, 60
\$34 (\$54)	MCUCSR	JTD	–	–	JTRF	WDRF	BORF	EXTRF	PORF	51, 255
\$33 (\$53)	TCCR0	FOC0	WGM00	COM01	COM00	WGM01	CS02	CS01	CS00	100
\$32 (\$52)	TCNT0	Timer/Counter0 (8 Bit)								102
\$31 (\$51)	OCR0	Timer/Counter0 Output Compare Register								102
\$30 (\$50)	ASSR	–	–	–	–	AS0	TCN0UB	OCR0UB	TCR0UB	103
\$2F (\$4F)	TCCR1A	COM1A1	COM1A0	COM1B1	COM1B0	COM1C1	COM1C0	WGM11	WGM10	130
\$2E (\$4E)	TCCR1B	ICNC1	ICES1	–	WGM13	WGM12	CS12	CS11	CS10	134
\$2D (\$4D)	TCNT1H	Timer/Counter1 – Counter Register High Byte								136
\$2C (\$4C)	TCNT1L	Timer/Counter1 – Counter Register Low Byte								136
\$2B (\$4B)	OCR1AH	Timer/Counter1 – Output Compare Register A High Byte								136
\$2A (\$4A)	OCR1AL	Timer/Counter1 – Output Compare Register A Low Byte								136
\$29 (\$49)	OCR1BH	Timer/Counter1 – Output Compare Register B High Byte								136
\$28 (\$48)	OCR1BL	Timer/Counter1 – Output Compare Register B Low Byte								136
\$27 (\$47)	ICR1H	Timer/Counter1 – Input Capture Register High Byte								137
\$26 (\$46)	ICR1L	Timer/Counter1 – Input Capture Register Low Byte								137
\$25 (\$45)	TCCR2	FOC2	WGM20	COM21	COM20	WGM21	CS22	CS21	CS20	156
\$24 (\$44)	TCNT2	Timer/Counter2 (8 Bit)								158
\$23 (\$43)	OCR2	Timer/Counter2 Output Compare Register								158
\$22 (\$42)	OCDR	IDRD/ OCDR7	OCDR6	OCDR5	OCDR4	OCDR3	OCDR2	OCDR1	OCDR0	252
\$21 (\$41)	WDTCR	–	–	–	WDCE	WDE	WDP2	WDP1	WDP0	53
\$20 (\$40)	SFIOR	TSM	–	–	–	ACME	PUD	PSR0	PSR321	69, 106, 143, 227
\$1F (\$3F)	EEARH	–	–	–	–	EEPROM Address Register High				19
\$1E (\$3E)	EEARL	EEPROM Address Register Low Byte								19
\$1D (\$3D)	EEDR	EEPROM Data Register								20
\$1C (\$3C)	EEDR	–	–	–	–	EERIE	EEMWE	EEWE	EERE	20
\$1B (\$3B)	PORTA	PORTA7	PORTA6	PORTA5	PORTA4	PORTA3	PORTA2	PORTA1	PORTA0	83
\$1A (\$3A)	DDRA	DDA7	DDA6	DDA5	DDA4	DDA3	DDA2	DDA1	DDA0	83
\$19 (\$39)	PINA	PINA7	PINA6	PINA5	PINA4	PINA3	PINA2	PINA1	PINA0	83
\$18 (\$38)	PORTB	PORTB7	PORTB6	PORTB5	PORTB4	PORTB3	PORTB2	PORTB1	PORTB0	83
\$17 (\$37)	DDRB	ddb7	ddb6	ddb5	ddb4	ddb3	ddb2	ddb1	ddb0	83
\$16 (\$36)	PINB	PINB7	PINB6	PINB5	PINB4	PINB3	PINB2	PINB1	PINB0	83
\$15 (\$35)	PORTC	PORTC7	PORTC6	PORTC5	PORTC4	PORTC3	PORTC2	PORTC1	PORTC0	83
\$14 (\$34)	DDRC	DDC7	DDC6	DDC5	DDC4	DDC3	DDC2	DDC1	DDC0	83
\$13 (\$33)	PINC	PINC7	PINC6	PINC5	PINC4	PINC3	PINC2	PINC1	PINC0	84
\$12 (\$32)	PORTD	PORTD7	PORTD6	PORTD5	PORTD4	PORTD3	PORTD2	PORTD1	PORTD0	84
\$11 (\$31)	DDRD	ddd7	ddd6	ddd5	ddd4	ddd3	ddd2	ddd1	ddd0	84
\$10 (\$30)	PIND	PIND7	PIND6	PIND5	PIND4	PIND3	PIND2	PIND1	PIND0	84
\$0F (\$2F)	SPDR	SPI Data Register								168
\$0E (\$2E)	SPSR	SPIF	WCOL	–	–	–	–	–	SPI2X	168
\$0D (\$2D)	SPCR	SPIE	SPE	DORD	MSTR	CPOL	CPHA	SPR1	SPR0	166
\$0C (\$2C)	UDR0	USART0 I/O Data Register								188
\$0B (\$2B)	UCSR0A	RXC0	TXC0	UDRE0	FE0	DOR0	UPE0	U2X0	MPCM0	188
\$0A (\$2A)	UCSR0B	RXCIE0	TXCIE0	UDRIE0	RXEN0	TXEN0	UCSZ02	RXB80	TXB80	189
\$09 (\$29)	UBRR0L	USART0 Baud Rate Register Low								192
\$08 (\$28)	ACSR	ACD	ACBG	ACO	ACI	ACIE	ACIC	ACIS1	ACIS0	227
\$07 (\$27)	ADMUX	REFS1	REFS0	ADLAR	MUX4	MUX3	MUX2	MUX1	MUX0	243
\$06 (\$26)	ADCSRA	ADEN	ADSC	ADFR	ADIF	ADIE	ADPS2	ADPS1	ADPS0	244
\$05 (\$25)	ADCH	ADC Data Register High Byte								246
\$04 (\$24)	ADCL	ADC Data Register Low byte								246
\$03 (\$23)	PORTE	PORTE7	PORTE6	PORTE5	PORTE4	PORTE3	PORTE2	PORTE1	PORTE0	84
\$02 (\$22)	DDRE	DDE7	DDE6	DDE5	DDE4	DDE3	DDE2	DDE1	DDE0	84



Register Summary (Continued)

Address	Name	Bit 7	Bit 6	Bit 5	Bit 4	Bit 3	Bit 2	Bit 1	Bit 0	Page
\$01 (\$21)	PINE	PINE7	PINE6	PINE5	PINE4	PINE3	PINE2	PINE1	PINE0	84
\$00 (\$20)	PINF	PINF7	PINF6	PINF5	PINF4	PINF3	PINF2	PINF1	PINF0	85

- Notes:
1. For compatibility with future devices, reserved bits should be written to zero if accessed. Reserved I/O memory addresses should never be written.
 2. Some of the status flags are cleared by writing a logical one to them. Note that the CBI and SBI instructions will operate on all bits in the I/O register, writing a one back into any flag read as set, thus clearing the flag. The CBI and SBI instructions work with registers \$00 to \$1F only.

Instruction Set Summary

Mnemonics	Operands	Description	Operation	Flags	#Clocks
ARITHMETIC AND LOGIC INSTRUCTIONS					
ADD	Rd, Rr	Add two Registers	$Rd \leftarrow Rd + Rr$	Z,C,N,V,H	1
ADC	Rd, Rr	Add with Carry two Registers	$Rd \leftarrow Rd + Rr + C$	Z,C,N,V,H	1
ADIW	Rd,K	Add Immediate to Word	$RdH:RdL \leftarrow RdH:RdL + K$	Z,C,N,V,S	2
SUB	Rd, Rr	Subtract two Registers	$Rd \leftarrow Rd - Rr$	Z,C,N,V,H	1
SUBI	Rd, K	Subtract Constant from Register	$Rd \leftarrow Rd - K$	Z,C,N,V,H	1
SBC	Rd, Rr	Subtract with Carry two Registers	$Rd \leftarrow Rd - Rr - C$	Z,C,N,V,H	1
SBCI	Rd, K	Subtract with Carry Constant from Reg.	$Rd \leftarrow Rd - K - C$	Z,C,N,V,H	1
SBIW	Rd,K	Subtract Immediate from Word	$RdH:RdL \leftarrow RdH:RdL - K$	Z,C,N,V,S	2
AND	Rd, Rr	Logical AND Registers	$Rd \leftarrow Rd \bullet Rr$	Z,N,V	1
ANDI	Rd, K	Logical AND Register and Constant	$Rd \leftarrow Rd \bullet K$	Z,N,V	1
OR	Rd, Rr	Logical OR Registers	$Rd \leftarrow Rd \vee Rr$	Z,N,V	1
ORI	Rd, K	Logical OR Register and Constant	$Rd \leftarrow Rd \vee K$	Z,N,V	1
EOR	Rd, Rr	Exclusive OR Registers	$Rd \leftarrow Rd \oplus Rr$	Z,N,V	1
COM	Rd	One's Complement	$Rd \leftarrow \$FF - Rd$	Z,C,N,V	1
NEG	Rd	Two's Complement	$Rd \leftarrow \$00 - Rd$	Z,C,N,V,H	1
SBR	Rd,K	Set Bit(s) in Register	$Rd \leftarrow Rd \vee K$	Z,N,V	1
CBR	Rd,K	Clear Bit(s) in Register	$Rd \leftarrow Rd \bullet (\$FF - K)$	Z,N,V	1
INC	Rd	Increment	$Rd \leftarrow Rd + 1$	Z,N,V	1
DEC	Rd	Decrement	$Rd \leftarrow Rd - 1$	Z,N,V	1
TST	Rd	Test for Zero or Minus	$Rd \leftarrow Rd \bullet Rd$	Z,N,V	1
CLR	Rd	Clear Register	$Rd \leftarrow Rd \oplus Rd$	Z,N,V	1
SER	Rd	Set Register	$Rd \leftarrow \$FF$	None	1
MUL	Rd, Rr	Multiply Unsigned	$R1:R0 \leftarrow Rd \times Rr$	Z,C	2
MULS	Rd, Rr	Multiply Signed	$R1:R0 \leftarrow Rd \times Rr$	Z,C	2
MULSU	Rd, Rr	Multiply Signed with Unsigned	$R1:R0 \leftarrow Rd \times Rr$	Z,C	2
FMUL	Rd, Rr	Fractional Multiply Unsigned	$R1:R0 \leftarrow (Rd \times Rr) \lll 1$	Z,C	2
FMULS	Rd, Rr	Fractional Multiply Signed	$R1:R0 \leftarrow (Rd \times Rr) \lll 1$	Z,C	2
FMULSU	Rd, Rr	Fractional Multiply Signed with Unsigned	$R1:R0 \leftarrow (Rd \times Rr) \lll 1$	Z,C	2
BRANCH INSTRUCTIONS					
RJMP	k	Relative Jump	$PC \leftarrow PC + k + 1$	None	2
IJMP		Indirect Jump to (Z)	$PC \leftarrow Z$	None	2
JMP	k	Direct Jump	$PC \leftarrow k$	None	3
RCALL	k	Relative Subroutine Call	$PC \leftarrow PC + k + 1$	None	3
ICALL		Indirect Call to (Z)	$PC \leftarrow Z$	None	3
CALL	k	Direct Subroutine Call	$PC \leftarrow k$	None	4
RET		Subroutine Return	$PC \leftarrow STACK$	None	4
RETI		Interrupt Return	$PC \leftarrow STACK$	I	4
CPSE	Rd,Rr	Compare, Skip if Equal	if $(Rd = Rr) PC \leftarrow PC + 2$ or 3	None	1 / 2 / 3
CP	Rd,Rr	Compare	$Rd - Rr$	Z, N, V, C, H	1
CPC	Rd,Rr	Compare with Carry	$Rd - Rr - C$	Z, N, V, C, H	1
CPI	Rd,K	Compare Register with Immediate	$Rd - K$	Z, N, V, C, H	1
SBRC	Rr, b	Skip if Bit in Register Cleared	if $(Rr(b)=0) PC \leftarrow PC + 2$ or 3	None	1 / 2 / 3
SBRS	Rr, b	Skip if Bit in Register is Set	if $(Rr(b)=1) PC \leftarrow PC + 2$ or 3	None	1 / 2 / 3
SBIC	P, b	Skip if Bit in I/O Register Cleared	if $(P(b)=0) PC \leftarrow PC + 2$ or 3	None	1 / 2 / 3
SBIS	P, b	Skip if Bit in I/O Register is Set	if $(P(b)=1) PC \leftarrow PC + 2$ or 3	None	1 / 2 / 3
BRBS	s, k	Branch if Status Flag Set	if $(SREG(s) = 1) then PC \leftarrow PC + k + 1$	None	1 / 2
BRBC	s, k	Branch if Status Flag Cleared	if $(SREG(s) = 0) then PC \leftarrow PC + k + 1$	None	1 / 2
BREQ	k	Branch if Equal	if $(Z = 1) then PC \leftarrow PC + k + 1$	None	1 / 2
BRNE	k	Branch if Not Equal	if $(Z = 0) then PC \leftarrow PC + k + 1$	None	1 / 2
BRCS	k	Branch if Carry Set	if $(C = 1) then PC \leftarrow PC + k + 1$	None	1 / 2
BRCC	k	Branch if Carry Cleared	if $(C = 0) then PC \leftarrow PC + k + 1$	None	1 / 2
BRSH	k	Branch if Same or Higher	if $(C = 0) then PC \leftarrow PC + k + 1$	None	1 / 2
BRLO	k	Branch if Lower	if $(C = 1) then PC \leftarrow PC + k + 1$	None	1 / 2
BRMI	k	Branch if Minus	if $(N = 1) then PC \leftarrow PC + k + 1$	None	1 / 2
BRPL	k	Branch if Plus	if $(N = 0) then PC \leftarrow PC + k + 1$	None	1 / 2
BRGE	k	Branch if Greater or Equal, Signed	if $(N \oplus V = 0) then PC \leftarrow PC + k + 1$	None	1 / 2
BRLT	k	Branch if Less Than Zero, Signed	if $(N \oplus V = 1) then PC \leftarrow PC + k + 1$	None	1 / 2
BRHS	k	Branch if Half Carry Flag Set	if $(H = 1) then PC \leftarrow PC + k + 1$	None	1 / 2
BRHC	k	Branch if Half Carry Flag Cleared	if $(H = 0) then PC \leftarrow PC + k + 1$	None	1 / 2
BRTS	k	Branch if T Flag Set	if $(T = 1) then PC \leftarrow PC + k + 1$	None	1 / 2
BRTC	k	Branch if T Flag Cleared	if $(T = 0) then PC \leftarrow PC + k + 1$	None	1 / 2
BRVS	k	Branch if Overflow Flag is Set	if $(V = 1) then PC \leftarrow PC + k + 1$	None	1 / 2
BRVC	k	Branch if Overflow Flag is Cleared	if $(V = 0) then PC \leftarrow PC + k + 1$	None	1 / 2



Instruction Set Summary (Continued)

Mnemonics	Operands	Description	Operation	Flags	#Clocks
BRIE	k	Branch if Interrupt Enabled	if (I = 1) then PC ← PC + k + 1	None	1 / 2
BRID	k	Branch if Interrupt Disabled	if (I = 0) then PC ← PC + k + 1	None	1 / 2
DATA TRANSFER INSTRUCTIONS					
MOV	Rd, Rr	Move Between Registers	Rd ← Rr	None	1
MOVW	Rd, Rr	Copy Register Word	Rd+1:Rd ← Rr+1:Rr	None	1
LDI	Rd, K	Load Immediate	Rd ← K	None	1
LD	Rd, X	Load Indirect	Rd ← (X)	None	2
LD	Rd, X+	Load Indirect and Post-Inc.	Rd ← (X), X ← X + 1	None	2
LD	Rd, -X	Load Indirect and Pre-Dec.	X ← X - 1, Rd ← (X)	None	2
LD	Rd, Y	Load Indirect	Rd ← (Y)	None	2
LD	Rd, Y+	Load Indirect and Post-Inc.	Rd ← (Y), Y ← Y + 1	None	2
LD	Rd, -Y	Load Indirect and Pre-Dec.	Y ← Y - 1, Rd ← (Y)	None	2
LDD	Rd, Y+q	Load Indirect with Displacement	Rd ← (Y + q)	None	2
LD	Rd, Z	Load Indirect	Rd ← (Z)	None	2
LD	Rd, Z+	Load Indirect and Post-Inc.	Rd ← (Z), Z ← Z+1	None	2
LD	Rd, -Z	Load Indirect and Pre-Dec.	Z ← Z - 1, Rd ← (Z)	None	2
LDD	Rd, Z+q	Load Indirect with Displacement	Rd ← (Z + q)	None	2
LDS	Rd, k	Load Direct from SRAM	Rd ← (k)	None	2
ST	X, Rr	Store Indirect	(X) ← Rr	None	2
ST	X+, Rr	Store Indirect and Post-Inc.	(X) ← Rr, X ← X + 1	None	2
ST	-X, Rr	Store Indirect and Pre-Dec.	X ← X - 1, (X) ← Rr	None	2
ST	Y, Rr	Store Indirect	(Y) ← Rr	None	2
ST	Y+, Rr	Store Indirect and Post-Inc.	(Y) ← Rr, Y ← Y + 1	None	2
ST	-Y, Rr	Store Indirect and Pre-Dec.	Y ← Y - 1, (Y) ← Rr	None	2
STD	Y+q, Rr	Store Indirect with Displacement	(Y + q) ← Rr	None	2
ST	Z, Rr	Store Indirect	(Z) ← Rr	None	2
ST	Z+, Rr	Store Indirect and Post-Inc.	(Z) ← Rr, Z ← Z + 1	None	2
ST	-Z, Rr	Store Indirect and Pre-Dec.	Z ← Z - 1, (Z) ← Rr	None	2
STD	Z+q, Rr	Store Indirect with Displacement	(Z + q) ← Rr	None	2
STS	k, Rr	Store Direct to SRAM	(k) ← Rr	None	2
LPM		Load Program Memory	R0 ← (Z)	None	3
LPM	Rd, Z	Load Program Memory	Rd ← (Z)	None	3
LPM	Rd, Z+	Load Program Memory and Post-Inc	Rd ← (Z), Z ← Z+1	None	3
ELPM		Extended Load Program Memory	R0 ← (RAMPZ:Z)	None	3
ELPM	Rd, Z	Extended Load Program Memory	Rd ← (RAMPZ:Z)	None	3
ELPM	Rd, Z+	Extended Load Program Memory and Post-Inc	Rd ← (RAMPZ:Z), RAMPZ:Z ← RAMPZ:Z+1	None	3
SPM		Store Program Memory	(Z) ← R1:R0	None	-
IN	Rd, P	In Port	Rd ← P	None	1
OUT	P, Rr	Out Port	P ← Rr	None	1
PUSH	Rr	Push Register on Stack	STACK ← Rr	None	2
POP	Rd	Pop Register from Stack	Rd ← STACK	None	2
BIT AND BIT-TEST INSTRUCTIONS					
SBI	P, b	Set Bit in I/O Register	I/O(P, b) ← 1	None	2
CBI	P, b	Clear Bit in I/O Register	I/O(P, b) ← 0	None	2
LSL	Rd	Logical Shift Left	Rd(n+1) ← Rd(n), Rd(0) ← 0	Z, C, N, V	1
LSR	Rd	Logical Shift Right	Rd(n) ← Rd(n+1), Rd(7) ← 0	Z, C, N, V	1
ROL	Rd	Rotate Left Through Carry	Rd(0) ← C, Rd(n+1) ← Rd(n), C ← Rd(7)	Z, C, N, V	1
ROR	Rd	Rotate Right Through Carry	Rd(7) ← C, Rd(n) ← Rd(n+1), C ← Rd(0)	Z, C, N, V	1
ASR	Rd	Arithmetic Shift Right	Rd(n) ← Rd(n+1), n=0..6	Z, C, N, V	1
SWAP	Rd	Swap Nibbles	Rd(3..0) ← Rd(7..4), Rd(7..4) ← Rd(3..0)	None	1
BSET	s	Flag Set	SREG(s) ← 1	SREG(s)	1
BCLR	s	Flag Clear	SREG(s) ← 0	SREG(s)	1
BST	Rr, b	Bit Store from Register to T	T ← Rr(b)	T	1
BLD	Rd, b	Bit load from T to Register	Rd(b) ← T	None	1
SEC		Set Carry	C ← 1	C	1
CLC		Clear Carry	C ← 0	C	1
SEN		Set Negative Flag	N ← 1	N	1
CLN		Clear Negative Flag	N ← 0	N	1
SEZ		Set Zero Flag	Z ← 1	Z	1
CLZ		Clear Zero Flag	Z ← 0	Z	1
SEI		Global Interrupt Enable	I ← 1	I	1
CLI		Global Interrupt Disable	I ← 0	I	1
SES		Set Signed Test Flag	S ← 1	S	1
CLS		Clear Signed Test Flag	S ← 0	S	1

Instruction Set Summary (Continued)

Mnemonics	Operands	Description	Operation	Flags	#Clocks
SEV		Set Twos Complement Overflow.	$V \leftarrow 1$	V	1
CLV		Clear Twos Complement Overflow	$V \leftarrow 0$	V	1
SET		Set T in SREG	$T \leftarrow 1$	T	1
CLT		Clear T in SREG	$T \leftarrow 0$	T	1
SEH		Set Half Carry Flag in SREG	$H \leftarrow 1$	H	1
CLH		Clear Half Carry Flag in SREG	$H \leftarrow 0$	H	1
MCU CONTROL INSTRUCTIONS					
NOP		No Operation		None	1
SLEEP		Sleep	(see specific descr. for Sleep function)	None	1
WDR		Watchdog Reset	(see specific descr. for WDR/timer)	None	1
BREAK		Break	For On-chip Debug Only	None	N/A



Ordering Information

Speed (MHz)	Power Supply	Ordering Code	Package	Operation Range
8	2.7 - 5.5V	ATmega128L-8AC	64A	Commercial (0°C to 70°C)
		ATmega128L-8MC	64M1	
		ATmega128L-8AI	64A	Industrial (-40°C to 85°C)
		ATmega128L-8MI	64M1	
16	4.5 - 5.5V	ATmega128-16AC	64A	Commercial (0°C to 70°C)
		ATmega128-16MC	64M1	
		ATmega128-16AI	64A	Industrial (-40°C to 85°C)
		ATmega128-16MI	64M1	

Note: 1. The device can also be supplied in wafer form. Please contact your local Atmel sales office for detailed ordering information and minimum quantities.

Package Type	
64A	64-lead, Thin (1.0 mm) Plastic Gull Wing Quad Flat Package (TQFP)
64M1	64-pad, 9 x 9 x 1.0 mm body, lead pitch 0.50 mm, Micro Lead Frame Package (MLF)

Packaging Information

64A

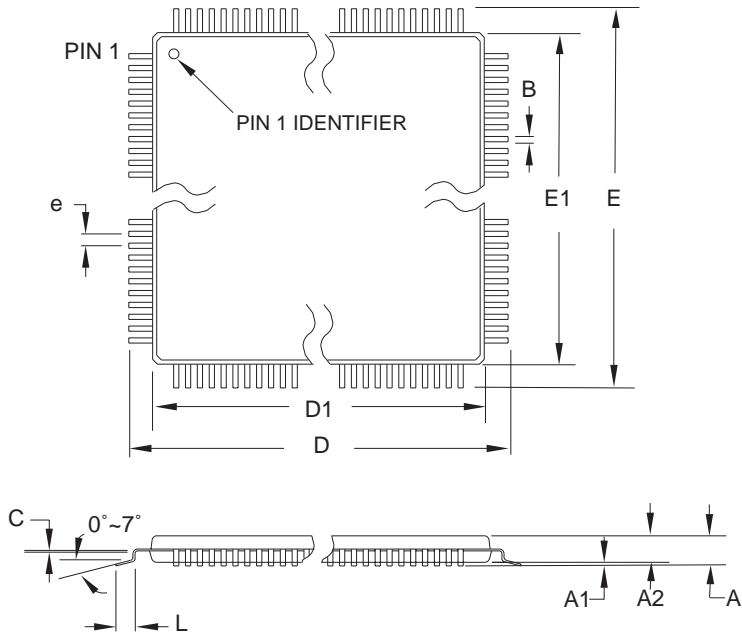

COMMON DIMENSIONS
(Unit of Measure = mm)

SYMBOL	MIN	NOM	MAX	NOTE
A	-	-	1.20	
A1	0.05	-	0.15	
A2	0.95	1.00	1.05	
D	15.75	16.00	16.25	
D1	13.90	14.00	14.10	Note 2
E	15.75	16.00	16.25	
E1	13.90	14.00	14.10	Note 2
B	0.30	-	0.45	
C	0.09	-	0.20	
L	0.45	-	0.75	
e	0.80 TYP			

- Notes:
1. This package conforms to JEDEC reference MS-026, Variation AEB.
 2. Dimensions D1 and E1 do not include mold protrusion. Allowable protrusion is 0.25 mm per side. Dimensions D1 and E1 are maximum plastic body size dimensions including mold mismatch.
 3. Lead coplanarity is 0.10 mm maximum.

10/5/2001

 2325 Orchard Parkway San Jose, CA 95131	TITLE	DRAWING NO.	REV.
	64A, 64-lead, 14 x 14 mm Body Size, 1.0 mm Body Thickness, 0.8 mm Lead Pitch, Thin Profile Plastic Quad Flat Package (TQFP)	64A	B

64M1

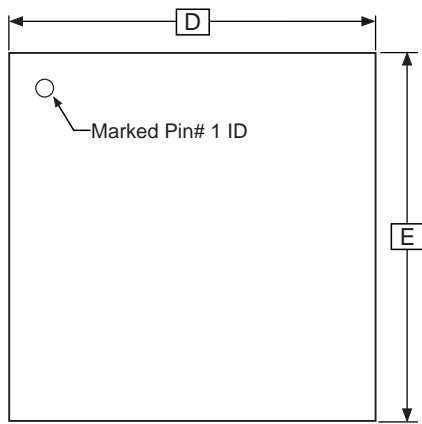

TOP VIEW

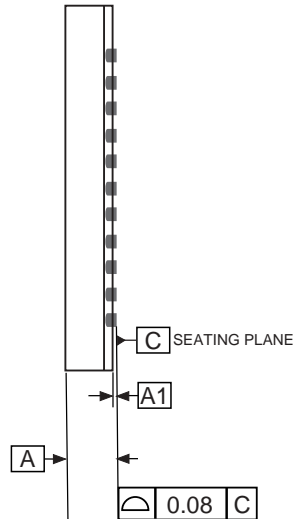

SIDE VIEW

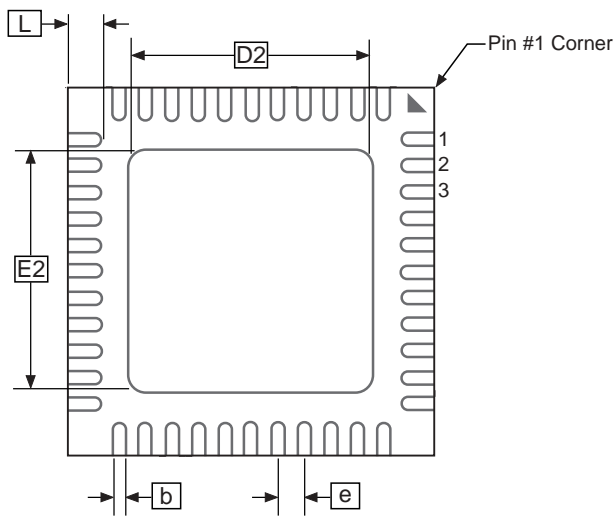

BOTTOM VIEW

COMMON DIMENSIONS
(Unit of Measure = mm)

SYMBOL	MIN	NOM	MAX	NOTE
A	0.80	0.90	1.00	
A1	—	0.02	0.05	
b	0.23	0.25	0.28	
D	9.00 BSC			
D2	5.20	5.40	5.60	
E	9.00 BSC			
E2	5.20	5.40	5.60	
e	0.50 BSC			
L	0.35	0.40	0.45	

Notes: 1. JEDEC Standard MO-220, Fig. 1, VMMD.

01/15/03



2325 Orchard Parkway
San Jose, CA 95131

TITLE

64M1, 64-pad, 9 x 9 x 1.0 mm Body, Lead Pitch 0.50 mm
Micro Lead Frame Package (MLF)

DRAWING NO.

64M1

REV.

C

Erratas

The revision letter in this section refers to the revision of the ATmega128 device.

ATmega128 Rev. H

There are no errata for this revision of ATmega128. However, a proposal for solving problems regarding the JTAG instruction IDCODE is presented below.

IDCODE masks data from TDI input

The public but optional JTAG instruction IDCODE is not implemented correctly according to IEEE1149.1; a logic one is scanned into the shift register instead of the TDI input while shifting the Device ID Register. Hence, captured data from the preceding devices in the boundary scan chain are lost and replaced by all-ones, and data to succeeding devices are replaced by all-ones during Update-DR.

If ATmega128 is the only device in the scan chain, the problem is not visible.

Problem Fix / Workaround

Select the Device ID Register of the ATmega128 (Either by issuing the IDCODE instruction or by entering the Test-Logic-Reset state of the TAP controller) to read out the contents of its Device ID Register and possibly data from succeeding devices of the scan chain. Note that data to succeeding devices cannot be entered during this scan, but data to preceding devices can. Issue the BYPASS instruction to the ATmega128 to select its Bypass Register while reading the Device ID Registers of preceding devices of the boundary scan chain. Never read data from succeeding devices in the boundary scan chain or upload data to the succeeding devices while the Device ID Register is selected for the ATmega128. Note that the IDCODE instruction is the default instruction selected by the Test-Logic-Reset state of the TAP-controller.

Alternative Problem Fix / Workaround

If the Device IDs of all devices in the boundary scan chain must be captured simultaneously (for instance if blind interrogation is used), the boundary scan chain can be connected in such way that the ATmega128 is the first device in the chain. Update-DR will still not work for the succeeding devices in the boundary scan chain as long as IDCODE is present in the JTAG Instruction Register, but the Device ID registered cannot be uploaded in any case.

ATmega128 Rev. G

There are no errata for this revision of ATmega128. However, a proposal for solving problems regarding the JTAG instruction IDCODE is presented below.

IDCODE masks data from TDI input

The public but optional JTAG instruction IDCODE is not implemented correctly according to IEEE1149.1; a logic one is scanned into the shift register instead of the TDI input while shifting the Device ID Register. Hence, captured data from the preceding devices in the boundary scan chain are lost and replaced by all-ones, and data to succeeding devices are replaced by all-ones during Update-DR.

If ATmega128 is the only device in the scan chain, the problem is not visible.

Problem Fix / Workaround

Select the Device ID Register of the ATmega128 (Either by issuing the IDCODE instruction or by entering the Test-Logic-Reset state of the TAP controller) to read out the contents of its Device ID Register and possibly data from succeeding devices of the scan chain. Note that data to succeeding devices cannot be entered during this scan, but data to preceding devices can. Issue the BYPASS instruction to the ATmega128 to select its Bypass Register while reading the Device ID Registers of preceding devices of the boundary scan chain. Never read data from



succeeding devices in the boundary scan chain or upload data to the succeeding devices while the Device ID Register is selected for the ATmega128. Note that the IDCODE instruction is the default instruction selected by the Test-Logic-Reset state of the TAP-controller.

Alternative Problem Fix / Workaround

If the Device IDs of all devices in the boundary scan chain must be captured simultaneously (for instance if blind interrogation is used), the boundary scan chain can be connected in such way that the ATmega128 is the first device in the chain. Update-DR will still not work for the succeeding devices in the boundary scan chain as long as IDCODE is present in the JTAG Instruction Register, but the Device ID registered cannot be uploaded in any case.

ATmega128 Rev. F

There are no errata for this revision of ATmega128. However, a proposal for solving problems regarding the JTAG instruction IDCODE is presented below.

IDCODE masks data from TDI input

The public but optional JTAG instruction IDCODE is not implemented correctly according to IEEE1149.1; a logic one is scanned into the shift register instead of the TDI input while shifting the Device ID Register. Hence, captured data from the preceding devices in the boundary scan chain are lost and replaced by all-ones, and data to succeeding devices are replaced by all-ones during Update-DR.

If ATmega128 is the only device in the scan chain, the problem is not visible.

Problem Fix / Workaround

Select the Device ID Register of the ATmega128 (Either by issuing the IDCODE instruction or by entering the Test-Logic-Reset state of the TAP controller) to read out the contents of its Device ID Register and possibly data from succeeding devices of the scan chain. Note that data to succeeding devices cannot be entered during this scan, but data to preceding devices can. Issue the BYPASS instruction to the ATmega128 to select its Bypass Register while reading the Device ID Registers of preceding devices of the boundary scan chain. Never read data from succeeding devices in the boundary scan chain or upload data to the succeeding devices while the Device ID Register is selected for the ATmega128. Note that the IDCODE instruction is the default instruction selected by the Test-Logic-Reset state of the TAP-controller.

Alternative Problem Fix / Workaround

If the Device IDs of all devices in the boundary scan chain must be captured simultaneously (for instance if blind interrogation is used), the boundary scan chain can be connected in such way that the ATmega128 is the first device in the chain. Update-DR will still not work for the succeeding devices in the boundary scan chain as long as IDCODE is present in the JTAG Instruction Register, but the Device ID registered cannot be uploaded in any case.

Datasheet Change Log for ATmega128

Please note that the referring page numbers in this section are referred to this document. The referring revision in this section are referring to the document revision.

Changes from Rev. 2467I-09/03 to Rev. 2467J-12/03

1. Updated “Calibrated Internal RC Oscillator” on page 39.

Changes from Rev. 2467H-02/03 to Rev. 2467I-09/03

1. Updated note in “XTAL Divide Control Register – XDIV” on page 41.
2. Updated “JTAG Interface and On-chip Debug System” on page 46.
3. Updated values for V_{BOT} (BODLEVEL = 1) in Table 19 on page 48.
4. Updated “Test Access Port – TAP” on page 247 regarding JTAGEN.
5. Updated description for the JTD bit on page 256.
6. Added a note regarding JTAGEN fuse to Table 119 on page 290.
7. Updated R_{PU} values in “DC Characteristics” on page 321.
8. Added a proposal for solving problems regarding the JTAG instruction IDCODE in “Erratas” on page 17.

Changes from Rev. 2467G-09/02 to Rev. 2467H-02/03

1. Corrected the names of the two Prescaler bits in the SFIOR Register.
2. Added Chip Erase as a first step under “Programming the Flash” on page 318 and “Programming the EEPROM” on page 319.
3. Removed reference to the “Multipurpose Oscillator” application note and the “32 kHz Crystal Oscillator” application note, which do not exist.
4. Corrected OCn waveforms in Figure 52 on page 122.
5. Various minor Timer1 corrections.
6. Added information about PWM symmetry for Timer0 and Timer2.
7. Various minor TWI corrections.
8. Added reference to Table 125 on page 293 from both SPI Serial Programming and Self Programming to inform about the Flash Page size.
9. Added note under “Filling the Temporary Buffer (Page Loading)” on page 282 about writing to the EEPROM during an SPM Page load.
10. Removed ADHSM completely.
11. Added section “EEPROM Write During Power-down Sleep Mode” on page 23.
12. Updated drawings in “Packaging Information” on page 15.

**Changes from Rev.
2467F-09/02 to Rev.
2467G-09/02**

1. Changed the Endurance on the Flash to 10,000 Write/Erase Cycles.

**Changes from Rev.
2467E-04/02 to Rev.
2467F-09/02**

1. Added 64-pad MLF Package and updated “Ordering Information” on page 14.
2. Added the section “Using all Locations of External Memory Smaller than 64 KB” on page 31.
3. Added the section “Default Clock Source” on page 35.
4. Renamed SPMCR to SPMCSR in entire document.
5. When using external clock there are some limitations regards to change of frequency. This is described in “External Clock” on page 40 and Table 132, “External Clock Drive,” on page 323.
6. Added a sub section regarding OCD-system and power consumption in the section “Minimizing Power Consumption” on page 45.
7. Corrected typo (WGM-bit setting) for:
“Fast PWM Mode” on page 95 (Timer/Counter0).
“Phase Correct PWM Mode” on page 97 (Timer/Counter0).
“Fast PWM Mode” on page 150 (Timer/Counter2).
“Phase Correct PWM Mode” on page 152 (Timer/Counter2).
8. Corrected Table 81 on page 192 (USART).
9. Corrected Table 103 on page 261 (Boundary-Scan)
10. Updated V_{il} parameter in “DC Characteristics” on page 321.

**Changes from Rev.
2467D-03/02 to Rev.
2467E-04/02**

1. Updated the Characterization Data in Section “ATmega128 Typical Characteristics – Preliminary Data” on page 333.
2. Updated the following tables:
Table 19 on page 48, Table 20 on page 52, Table 68 on page 157, Table 103 on page 261, and Table 136 on page 327.
3. Updated Description of OSCCAL Calibration Byte.
In the data sheet, it was not explained how to take advantage of the calibration bytes for 2, 4, and 8 MHz Oscillator selections. This is now added in the following sections:
Improved description of “Oscillator Calibration Register – OSCCAL” on page 39 and “Calibration Byte” on page 291.

**Changes from Rev.
2467C-02/02 to Rev.
2467D-03/02**

1. Added more information about “ATmega103 Compatibility Mode” on page 5.
2. Updated Table 2, “EEPROM Programming Time,” on page 21.

3. Updated typical Start-up Time in Table 7 on page 35, Table 9 and Table 10 on page 37, Table 12 on page 38, Table 14 on page 39, and Table 16 on page 40.
4. Updated Table 22 on page 54 with typical WDT Time-out.
5. Corrected description of ADSC bit in “ADC Control and Status Register A – ADCSRA” on page 244.
6. Improved description on how to do a polarity check of the ADC diff results in “ADC Conversion Result” on page 241.
7. Corrected JTAG version numbers in “JTAG Version Numbers” on page 254.
8. Improved description of addressing during SPM (usage of RAMPZ) on “Addressing the Flash During Self-Programming” on page 280, “Performing Page Erase by SPM” on page 282, and “Performing a Page Write” on page 282.
9. Added note regarding OCDEN Fuse below Table 119 on page 290.
10. Updated Programming Figures:
Figure 135 on page 292 and Figure 144 on page 304 are updated to also reflect that AVCC must be connected during Programming mode. Figure 139 on page 299 added to illustrate how to program the fuses.
11. Added a note regarding usage of the PROG_PAGELOAD and PROG_PAGEREAD instructions on page 310.
12. Added Calibrated RC Oscillator characterization curves in section “ATmega128 Typical Characteristics – Preliminary Data” on page 333.
13. Updated “Two-wire Serial Interface” section.
More details regarding use of the TWI Power-down operation and using the TWI as master with low TWBRR values are added into the data sheet. Added the note at the end of the “Bit Rate Generator Unit” on page 203. Added the description at the end of “Address Match Unit” on page 204.
14. Added a note regarding usage of Timer/Counter0 combined with the clock. See “XTAL Divide Control Register – XDIV” on page 41.

Changes from Rev. 2467B-09/01 to Rev. 2467C-02/02

1. **Corrected Description of Alternate Functions of Port G**
Corrected description of TOSC1 and TOSC2 in “Alternate Functions of Port G” on page 81.
2. **Added JTAG Version Numbers for rev. F and rev. G**
Updated Table 100 on page 254.
3. **Added Some Preliminary Test Limits and Characterization Data**
Removed some of the TBD's in the following tables and pages:
Table 19 on page 48, Table 20 on page 52, “DC Characteristics” on page 321, Table 132 on page 323, Table 135 on page 325, and Table 136 on page 327.

4. **Corrected “Ordering Information” on page 14.**
5. **Added some Characterization Data in Section “ATmega128 Typical Characteristics – Preliminary Data” on page 333.**
6. **Removed Alternative Algorithm for Leaving JTAG Programming Mode.**
See “Leaving Programming Mode” on page 318.
7. **Added Description on How to Access the Extended Fuse Byte Through JTAG Programming Mode.**
See “Programming the Fuses” on page 320 and “Reading the Fuses and Lock Bits” on page 320.



Atmel Headquarters

Corporate Headquarters

2325 Orchard Parkway
San Jose, CA 95131
TEL 1(408) 441-0311
FAX 1(408) 487-2600

Europe

Atmel Sarl
Route des Arsenaux 41
Case Postale 80
CH-1705 Fribourg
Switzerland
TEL (41) 26-426-5555
FAX (41) 26-426-5500

Asia

Room 1219
Chinachem Golden Plaza
77 Mody Road Tsimhatsui
East Kowloon
Hong Kong
TEL (852) 2721-9778
FAX (852) 2722-1369

Japan

9F, Tonetsu Shinkawa Bldg.
1-24-8 Shinkawa
Chuo-ku, Tokyo 104-0033
Japan
TEL (81) 3-3523-3551
FAX (81) 3-3523-7581

Atmel Operations

Memory

2325 Orchard Parkway
San Jose, CA 95131
TEL 1(408) 441-0311
FAX 1(408) 436-4314

Microcontrollers

2325 Orchard Parkway
San Jose, CA 95131
TEL 1(408) 441-0311
FAX 1(408) 436-4314

La Chantrerie
BP 70602
44306 Nantes Cedex 3, France
TEL (33) 2-40-18-18-18
FAX (33) 2-40-18-19-60

ASIC/ASSP/Smart Cards

Zone Industrielle
13106 Rousset Cedex, France
TEL (33) 4-42-53-60-00
FAX (33) 4-42-53-60-01

1150 East Cheyenne Mtn. Blvd.
Colorado Springs, CO 80906
TEL 1(719) 576-3300
FAX 1(719) 540-1759

Scottish Enterprise Technology Park
Maxwell Building
East Kilbride G75 0QR, Scotland
TEL (44) 1355-803-000
FAX (44) 1355-242-743

RF/Automotive

Theresienstrasse 2
Postfach 3535
74025 Heilbronn, Germany
TEL (49) 71-31-67-0
FAX (49) 71-31-67-2340

1150 East Cheyenne Mtn. Blvd.
Colorado Springs, CO 80906
TEL 1(719) 576-3300
FAX 1(719) 540-1759

Biometrics/Imaging/Hi-Rel MPU/ High Speed Converters/RF Datacom

Avenue de Rochepleine
BP 123
38521 Saint-Egreve Cedex, France
TEL (33) 4-76-58-30-00
FAX (33) 4-76-58-34-80

e-mail

literature@atmel.com

Web Site

<http://www.atmel.com>

© Atmel Corporation 2003.

Atmel Corporation makes no warranty for the use of its products, other than those expressly contained in the Company's standard warranty which is detailed in Atmel's Terms and Conditions located on the Company's web site. The Company assumes no responsibility for any errors which may appear in this document, reserves the right to change devices or specifications detailed herein at any time without notice, and does not make any commitment to update the information contained herein. No licenses to patents or other intellectual property of Atmel are granted by the Company in connection with the sale of Atmel products, expressly or by implication. Atmel's products are not authorized for use as critical components in life support devices or systems.

All rights reserved. Atmel® and combinations thereof, AVR®, and AVR Studio® are the registered trademarks of Atmel Corporation or its subsidiaries. Microsoft®, Windows®, Windows NT®, and Windows XP® are the registered trademarks of Microsoft Corporation. Other terms and product names may be the trademarks of others



Printed on recycled paper.



LittleDiode supplies new, hard to find or obsolete electronic components and semiconductors all over the world.

With over two million different components listed you are sure to find the part you need.

Feel free to visit us today at our online store:

LittleDiode.com

Looking forward to providing you with the best possible service.