

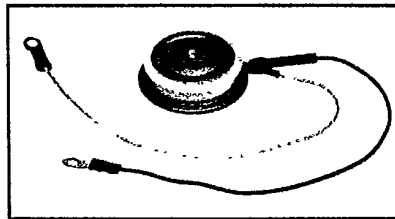

**C431**

Powerex, Inc. Hillis Street, Youngwood, Pennsylvania 15697 (412) 925-7272  
 Powerex Europe, S.A., 428 Ave. G. Durand, BP107, 72003 LeMans, France (43) 72.75.15

**Phase Control SCR**  
**450-600 Amperes Avg**  
**500-1800 Volts**

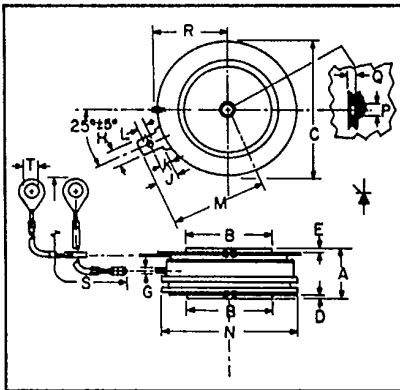

**C431**  
**Phase Control SCR**  
 450-600 Amperes/500-1800 Volts

**C431**  
**Outline Drawing**

Dimensions	Inches		Millimeters	
	Min.	Max.	Min.	Max.
A	.560	.605	14.22	15.37
B	.985	.995	25.01	25.27
C	1.600	1.650	40.64	41.91
D	.030	—	.76	—
E	.040	—	1.01	—
G	.057	.059	1.44	1.50
H	.186	.191	4.72	4.85
J	.245	.255	6.22	6.48
K	.115	.130	2.92	3.30
L	.064	.070	1.62	1.78
M	—	1.120	—	28.45
N	—	1.585	—	40.26
P	.135	.145	3.42	3.68
Q	.070	.084	1.77	2.13
R	—	.875	—	22.23
S	12.219	12.343	310.36	313.51
T	.137	.153	3.47	3.89

**Description**

Powerex Silicon Controlled Rectifiers (SCR) are designed for phase control applications. These are all-diffused, Press-Pak (Pow-R-Disc) devices employing the field-proven amplifying (di/namic) gate.

**Features:**

- Low On-State Voltage
- High di/dt
- High dv/dt
- Hermetic Packaging
- Excellent Surge and I<sup>2</sup>t Ratings

**Applications:**

- Power Supplies
- Battery Chargers
- Motor Control
- Light Dimmers
- VAR Generators

**Ordering Information**

Example: Select the complete six or seven digit part number you desire from the table – i.e. C431T1 is a 900 Volt, 600 Ampere Phase Control SCR.

Type	Voltage		Current	
	V <sub>DRM</sub> V <sub>RRM</sub>	Code	I <sub>T</sub> (avg)	Code
C431	500	E	450	2
	600	M		
	700	S	600	1
	800	N		
	900	T		
	1000	P		
	1100	PA		
	1200	PB		
	1300	PC		
	1400	PD		
	1500	PE		
	1600	PM		



T-25-20

Powerex, Inc., Hillis Street, Youngwood, Pennsylvania 15697 (412) 925-7272

Powerex Europe, S.A., 428 Ave. G. Durand, BP107, 72003 LeMans, France (43) 72.75.15

C431

Phase Control SCR

450-600 Amperes Avg/500-1800 Volts

### Absolute Maximum Ratings

	Symbol	C431...1	C431...2	Units
RMS On-State Current	$I_{T(RMS)}$	950	700	Amperes
Average On-State Current	$I_{T(av)}$	600	450	Amperes
Peak One-Cycle Surge (Non Repetitive) On-State Current (60Hz)	$I_{TSM}$	8000	6500	Amperes
Peak One-Cycle Surge (Non-Repetitive) On-State Current (50Hz)	$I_{TSM}$	7300	5950	Amperes
Critical Rate-of-Rise of On-State Current (Non-Repetitive)	di/dt	150	150	Amperes/ $\mu$ s
Critical Rate-of-Rise of On-State Current (Repetitive)	di/dt	100	100	Amperes/ $\mu$ s
$I^2t$ (for Fusing), One Cycle at 60Hz	$I^2t$	$2.678 \times 10^5$	$1.76 \times 10^5$	A <sup>2</sup> sec
Peak Gate Power Dissipation	$P_{GM}$	200	200	Watts
Average Gate Power Dissipation	$P_{G(av)}$	5	5	Watts
Storage Temperature	$T_{STG}$	-40 to 150	-40 to 150	°C
Operating Temperature	$T_J$	-40 to 125	-40 to 125	°C
Mounting Force <sup>ⓐ</sup>		800-2500	800-2500	lb.
Mounting Force <sup>ⓐ</sup>		3.6-11.1	3.6-11.1	kN

<sup>ⓐ</sup> Consult recommended mounting procedures.



T-25-20

Powerex, Inc., Hillis Street, Youngwood, Pennsylvania 15697 (412) 925-7272  
 Powerex Europe, S.A., 428 Ave. G. Durand, BP107, 72003 LeMans, France (43) 72.75.15

C431  
 Phase Control SCR  
 450-600 Amperes Avg/500-1800 Volts

### Electrical and Thermal Characteristics

	Symbol	Test Conditions	C431_1	C431_2	Units
<b>Current—Conducting State Maximums</b>					
Peak On-State Voltage	$V_{TM}$	$I_{TM} = 3000A$ Peak, $T_J = 25^\circ C$ , Duty Cycle $\leq 0.01\%$	2.62	3.6	Volts
<b>Voltage—Blocking State Maximums</b>					
Forward Leakage, Peak	$I_{DRM}$	$T_J = 125^\circ C$ , $V = V_{DRM}$	45	60	mA
Reverse Leakage, Peak	$I_{RRM}$	$T_J = 125^\circ C$ , $V = V_{RRM}$	45	60	mA
<b>Switching</b>					
Typical Turn-Off Time	$t_q$	$T_J = 125^\circ C$ , $I_{TM} = 500A$ ; $V_R = 50V$ Min; $V_{DRM}$ (Reapplied); $dv/dt = 20V/\mu sec$ (linear); Commutation $di/dt = 25A/\mu sec$ ; Repetition Rate = 1pps; Gate Bias during Turn-Off Interval = 0V, 100 $\Omega$	200	75	$\mu sec$
Typical Delay Time	$t_d$	$T_J = 25^\circ C$ , $I_T = 50A$ , Gate Supply: 20V, 20 $\Omega$ , 0.1 $\mu sec$ rise time	<b>C431</b>		$\mu sec$
Min. Critical $dv/dt$ exponential to $V_{DRM}$	$dv/dt$	$T_J = 125^\circ C$ , $V_{DRM} = .8$ Rated, Gate Open	200		V/ $\mu sec$
<b>Thermal and Mechanical</b>					
Maximum Thermal Resistance, <sup>ⓐ</sup> double sided cooling					
Junction to Case (2000 lb force)	$R_{\theta JC}$		.045		$^\circ C/Watt$
Case to Sink, Lubricated (2000 lb force)	$R_{\theta CS}$		.02		$^\circ C/Watt$
<b>Gate—Maximum Parameters</b>					
Gate Current to Trigger	$I_{GT}$	$V_D = 6Vdc$ , $T_J = 25^\circ C$ , $R_L = 3\Omega$	150		mA
Gate Voltage to Trigger	$V_{GT}$	$T_J = -40$ to $125^\circ C$ , $V_D = 6Vdc$ , $R_L = 3\Omega$	5		Volts
Non-Triggering Gate Voltage	$V_{GDM}$	$T_J = 125^\circ C$ , Rated $V_{DRM}$ , $R_L = 1000\Omega$	.15		Volts
Peak Forward Gate Current	$I_{GTM}$		10		Amperes
Peak Reverse Gate Voltage	$V_{GRM}$		5		Volts

<sup>ⓐ</sup> Consult recommended mounting procedures.



T-25-70

Powerex, Inc., Hillis Street, Youngwood, Pennsylvania 15697 (412) 925-7272

Powerex Europe, S.A., 428 Ave. G. Durand, BP107, 72003 LeMans, France (43) 72.75.15

C431

Phase Control SCR

450-600 Amperes Avg/500-1800 Volts

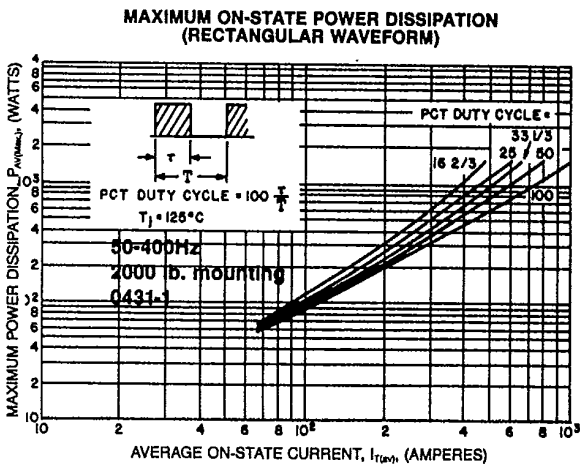
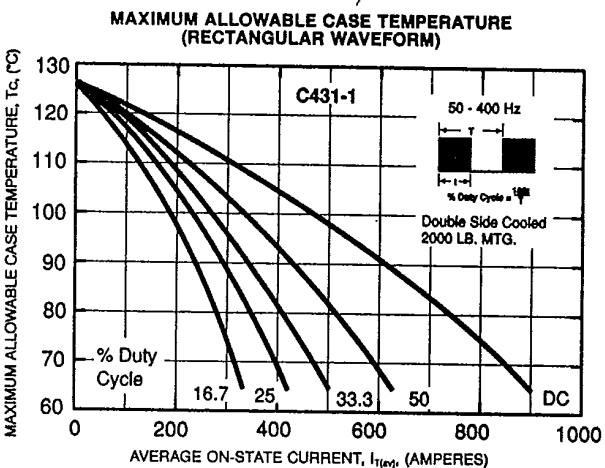
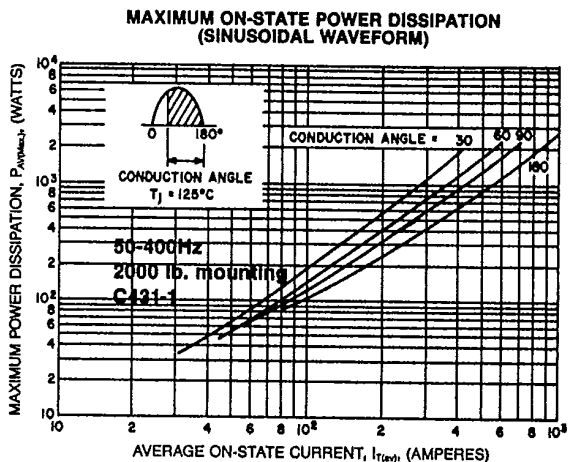
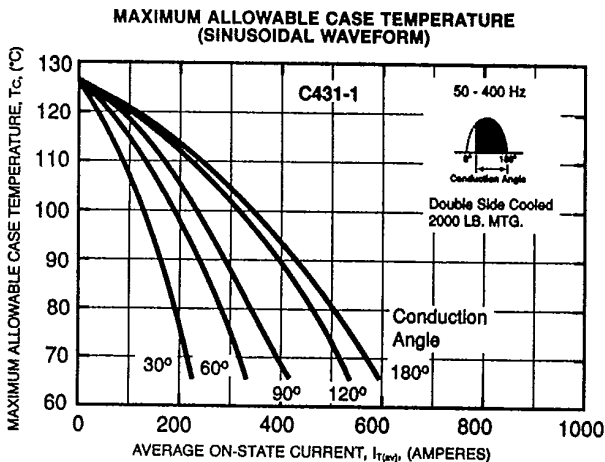
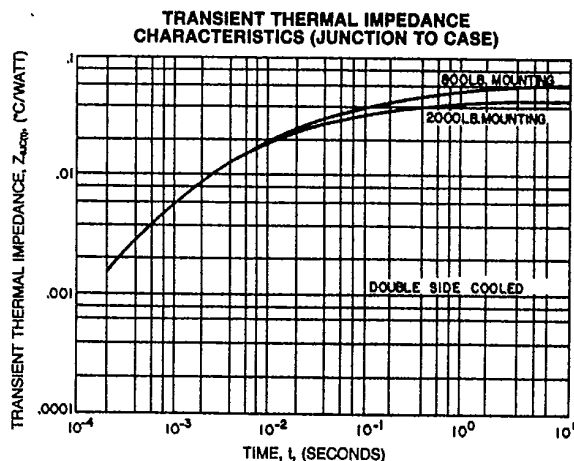
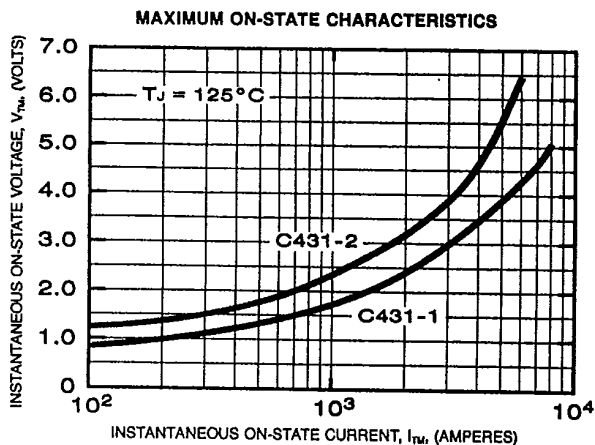



T-25-20

Powerex, Inc., Hillis Street, Youngwood, Pennsylvania 15697 (412) 925-7272  
 Powerex Europe, S.A., 428 Ave. G. Durand, BP107, 72003 LeMans, France (43) 72.75.15

**C431**  
**Phase Control SCR**  
 450-600 Amperes Avg/500-1800 Volts

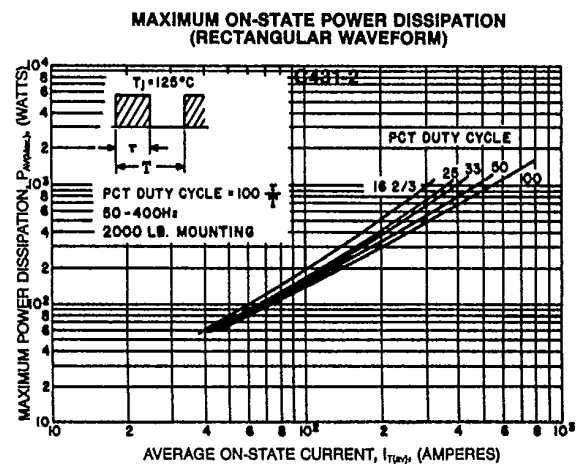
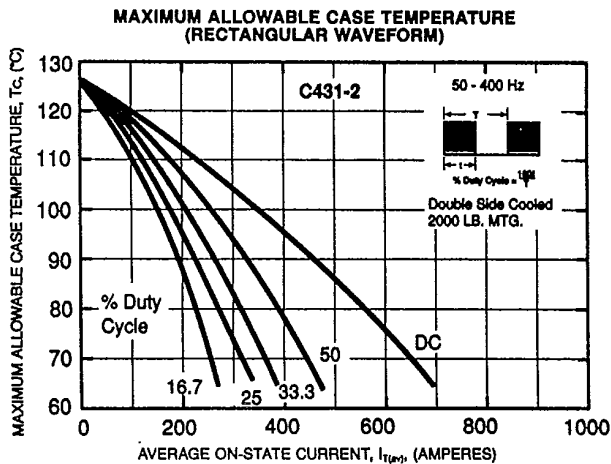
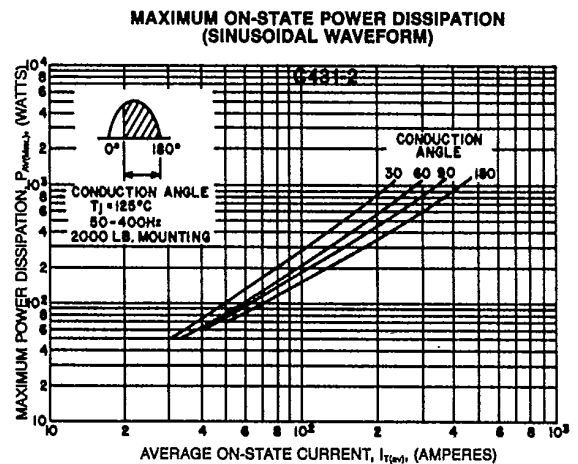
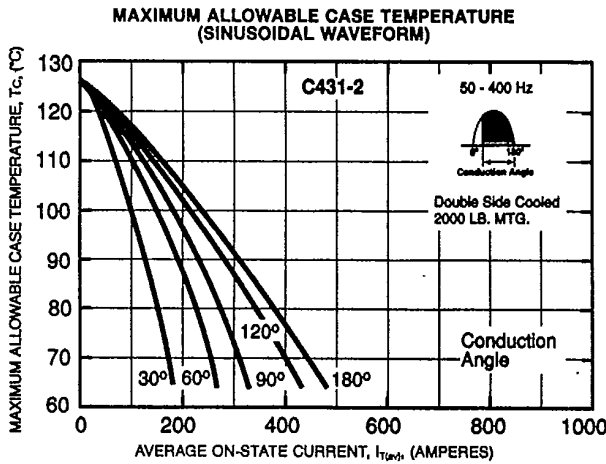
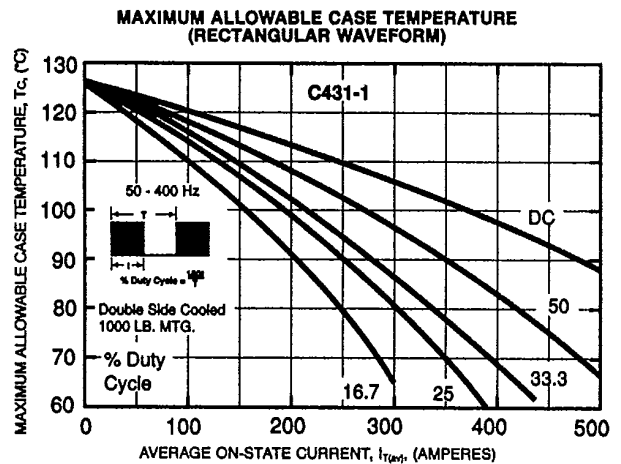
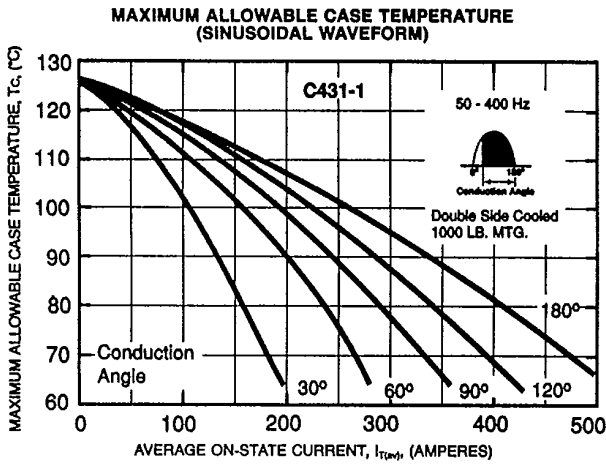



T-25-20

Powerex, Inc., Hillis Street, Youngwood, Pennsylvania 15697 (412) 925-7272  
 Powerex Europe, S.A., 428 Ave. G. Durand, BP107, 72003 LeMans, France (43) 72.75.15

**C431**  
 Phase Control SCR  
 450-600 Amperes Avg/500-1800 Volts

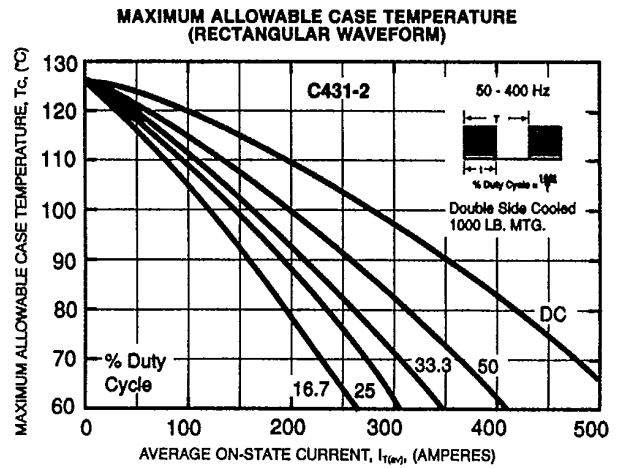
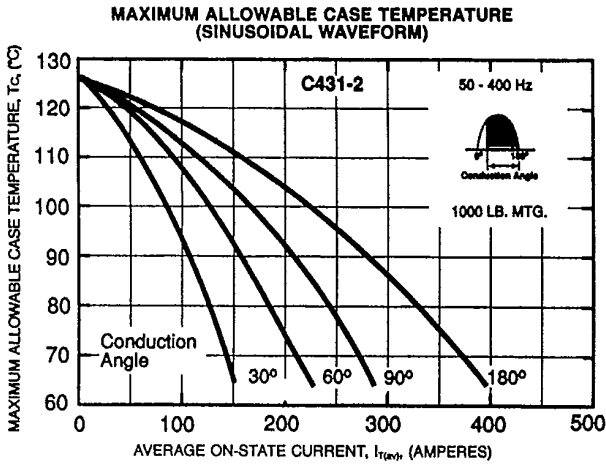

**SUB-CYCLE SURGE AND I<sup>2</sup>t RATINGS (RATED LOAD CONDITIONS)**

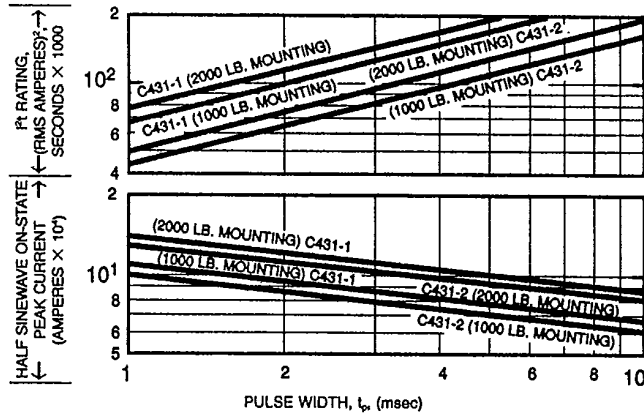

**MAXIMUM RECOVERED CHARGE**

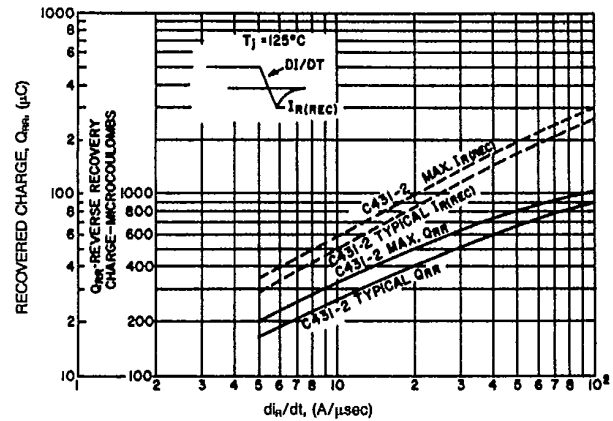

**GATE CHARACTERISTICS**

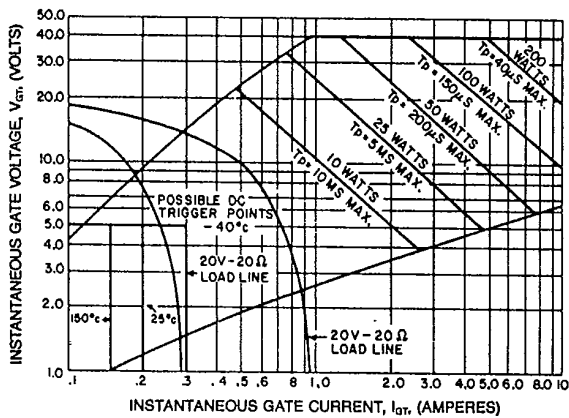

**NOTES:**

1. Maximum allowable average gate dissipation = 5 watts.
2. The locus of possible dc trigger points lie outside the boundaries shown at various case temperatures.
3. T<sub>p</sub> = Rectangular gate current pulse width (5μs min. duration; 1.0μs max. rise time for 20V, 65Ω source).
4. 20V - 20Ω is the minimum gate source load line when rate of circuit current rise > 100 Amp/μs or anode rate of current rise > 200 Amps/μs (T<sub>p</sub> = 5μs min., 0.5μs max. rise time).

Maximum long-term repetitive anode di/dt = 500 Amps/μs with 20V - 20Ω gate source.



LittleDiode supplies new, hard to find or obsolete electronic components and semiconductors all over the world.

With over two million different components listed you are sure to find the part you need.

Feel free to visit us today at our online store:

[LittleDiode.com](http://LittleDiode.com)

Looking forward to providing you with the best possible service.