

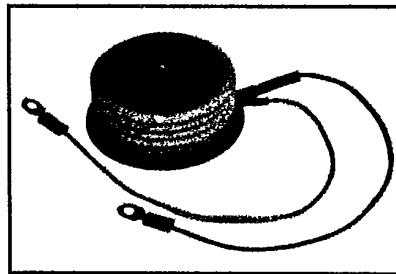

**C450**

Powerex, Inc. Hillis Street, Youngwood, Pennsylvania 15697 (412) 925-7272  
 Powerex Europe, S.A., 428 Ave. G. Durand, BP107, 72003 LeMans, France (43) 72.75.15

**Phase Control SCR**  
 1460-1640 Amperes Avg  
 500-1400 Volts

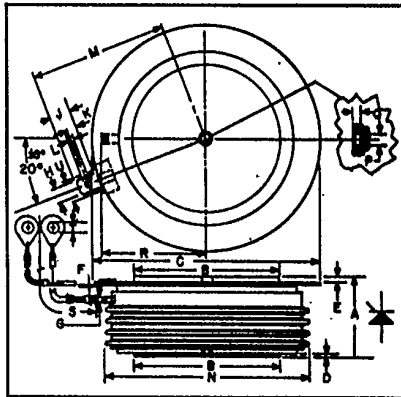

**C450**  
 Phase Control SCR  
 1460-1640 Amperes/500-1400 Volts

**C450**  
 Outline Drawing

Dimensions	Inches		Millimeters	
	Min.	Max.	Min.	Max.
A	1.020	1.065	25.90	27.05
B	1.845	1.855	46.86	47.12
C	—	2.940	—	74.68
D	.030	—	.76	—
E	.050	—	1.27	—
F	.017	.023	.43	.58
G	.057	.059	1.44	1.50
H	.186	.191	4.72	4.85
J	.245	.255	6.22	6.48
K	.115	.130	2.92	3.30
L	.064	.070	1.62	1.78
M	—	1.800	—	45.72
N	—	2.650	—	67.31
P	.135	.145	3.42	3.68
Q	.070	.100	1.77	2.54
R	—	1.355	—	34.42
S	12.219	12.343	310.36	313.51
T	.137	.153	3.47	3.89

**Description**

Powerex Silicon Controlled Rectifiers (SCR) are designed for phase control applications. These are all-diffused, Press-Pak (Pow-R-Disc) devices employing the field-proven amplifying (di/namic) gate.

**Features:**

- Low On-State Voltage
- High di/dt
- High dv/dt
- Hermetic Packaging
- Excellent Surge and I<sup>2</sup>t Ratings

**Applications:**

- Power Supplies
- Battery Chargers
- Motor Control
- Light Dimmers
- VAR Generators

**Ordering Information**

Example: Select the complete six or seven digit part number you desire from the table - i.e. C450P1 is a 1000 Volt, 1640 Ampere Phase Control SCR.

Type	Voltage		Current	
	V <sub>ORM</sub>	V <sub>RRM</sub>	I <sub>T</sub> (avg)	Code
C450	500	E	1460	2
	600	M		
	700	S	1640	1
	800	N		
	900	T		
	1000	P		
	1100	PA		
	1200	PB		
	1300	PC		
	1400	PD		



Powerex, Inc., Hillis Street, Youngwood, Pennsylvania 15697 (412) 925-7272

Powerex Europe, S.A., 428 Ave. G. Durand, BP107, 72003 LeMans, France (43) 72.75.15

### C450

Phase Control SCR

1460-1640 Amperes Avg/500-1400 Volts

### Absolute Maximum Ratings

	Symbol	C450-1	C450-2	Units
RMS On-State Current	$I_{T(RMS)}$	2575	2300	Amperes
Average On-State Current	$I_{T(av)}$	1640	1460	Amperes
Peak One-Cycle Surge (Non Repetitive) On-State Current (60Hz)	$I_{TSM}$	28500	25,000	Amperes
Peak One-Cycle Surge (Non-Repetitive) On-State Current (50Hz)	$I_{TSM}$	26,000	22,800	Amperes
Critical Rate-of-Rise of On-State Current (Non-Repetitive)	$di/dt$	800	800	Amperes/ $\mu$ s
Critical Rate-of-Rise of On-State Current (Repetitive)	$di/dt$	400	400	Amperes/ $\mu$ s
$I^2t$ (for Fusing), One Cycle at 60Hz	$I^2t$	$3.4 \times 10^6$	$2.6 \times 10^6$	A <sup>2</sup> sec
Peak Gate Power Dissipation	$P_{GM}$	200	200	Watts
Average Gate Power Dissipation	$P_{G(av)}$	5	5	Watts
Storage Temperature	$T_{STG}$	-40 to 150	-40 to 150	°C
Operating Temperature	$T_J$	-40 to 125	-40 to 125	°C
Mounting Force <sup>ⓐ</sup>		5500 to 6000	5500 to 6000	lb.
Mounting Force <sup>ⓐ</sup>		24.5 to 26.7	24.5 to 26.7	kN

### Electrical and Thermal Characteristics

Characteristics	Symbol	Test Conditions	C450-1	C450-2	Units
<b>Current—Conducting State Maximums</b>					
Peak On-State Voltage	$V_{TM}$	$I_{TM} = 3000A$ Peak, $T_J = 25^\circ C$	1.4	1.65	Volts
C450					
<b>Voltage—Blocking State Maximums</b>					
Forward Leakage, Peak	$I_{DRM}$	$T_J = 125^\circ C, V = V_{DRM}$	45		mA
Reverse Leakage, Peak	$I_{RRM}$	$T_J = 125^\circ C, V = V_{RRM}$	45		mA
<b>Switching</b>					
Typical Turn-Off Time	$t_q$	$T_J = 125^\circ C, I_T = 2000A, \text{Pulse Width} = 1000 \mu\text{sec}; V_R = 50V; dv/dt = 200V/\mu\text{sec}; \text{Linear to } V_{DRM}; di_R/dt = 25A/\mu\text{sec}; VG = 0, R_L = 100\Omega$	150		$\mu\text{sec}$
Typical Delay Time	$t_d$	$T_J = 25^\circ C; I_T = 50A; \text{Gate supply } 20V; R_L = 20\Omega; 0.1 \mu\text{sec Rise Time}$		.7	$\mu\text{sec}$
Min. Critical $dv/dt$ exponential to $V_{DRM}$	$dv/dt$	$T_J = 125^\circ C$	400		V/ $\mu\text{sec}$
<b>Thermal</b>					
Maximum Thermal Resistance, <sup>ⓐ</sup> double sided cooling Junction to Case	$R_{\theta JC}$			.025	°C/Watt
Case to Sink, Lubricated	$R_{\theta CS}$			.0075	°C/Watt
<b>Gate—Maximum Parameters</b>					
Gate Current to Trigger	$I_{GT}$	$T_J = 25^\circ C, V_D = 20V, R_L = 3 \Omega$	200		mA
Gate Voltage to Trigger	$V_{GT}$	$T_J = -40^\circ \text{ to } 125^\circ C, V_D = 20V, R_L = 3 \Omega$	5		Volts
Non-Triggerring Gate Voltage	$V_{GDM}$	$T_J = 125^\circ C, V_D = \text{rated } V_{DRM}, R_L = 1000 \Omega$	.15		Volts
Peak Forward Gate Current	$I_{GTM}$		10		Amperes
Peak Reverse Gate Voltage	$V_{GRM}$		5		Volts

<sup>ⓐ</sup> Consult recommended mounting procedures.



Powerex, Inc., Hillis Street, Youngwood, Pennsylvania 15697 (412) 925-7272  
 Powerex Europe, S.A., 428 Ave. G. Durand, BP107, 72003 LeMans, France (43) 72.75.15

**C450**  
 Phase Control SCR  
 1460-1640 Amperes Avg/500-1400 Volts

MAXIMUM ON-STATE CHARACTERISTICS

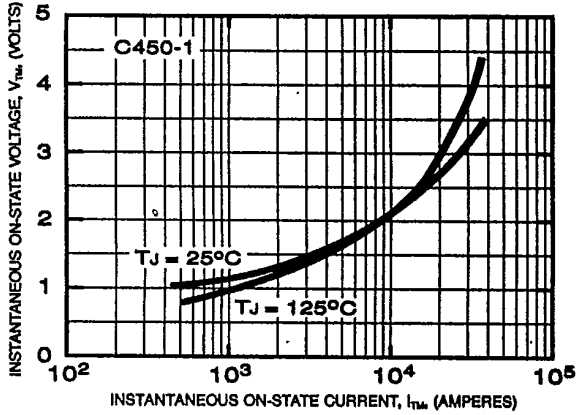

TRANSIENT THERMAL IMPEDANCE CHARACTERISTICS (JUNCTION TO CASE)

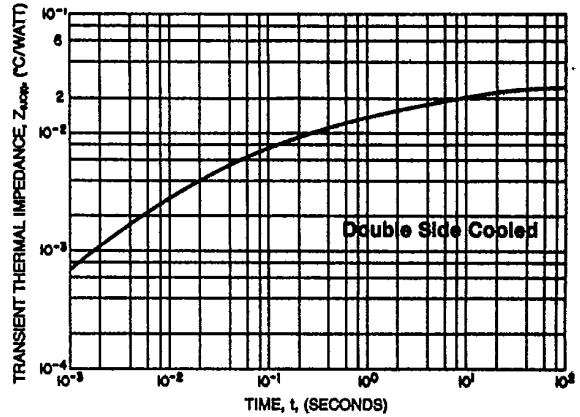

MAXIMUM ALLOWABLE CASE TEMPERATURE (SINUSOIDAL WAVEFORM)

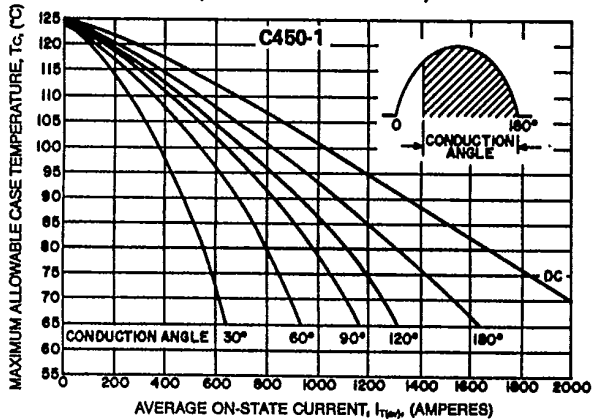

MAXIMUM ON-STATE POWER DISSIPATION (SINUSOIDAL WAVEFORM)

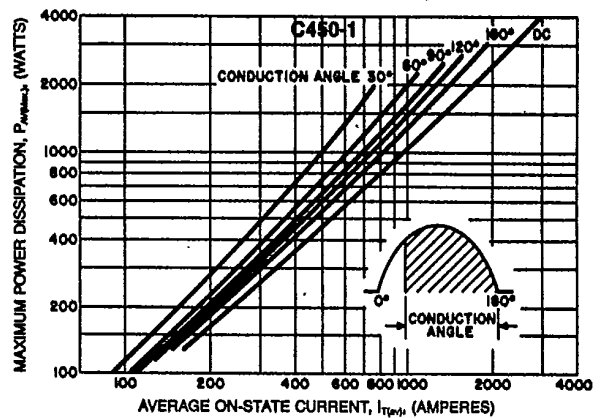

MAXIMUM ALLOWABLE CASE TEMPERATURE (RECTANGULAR WAVEFORM)

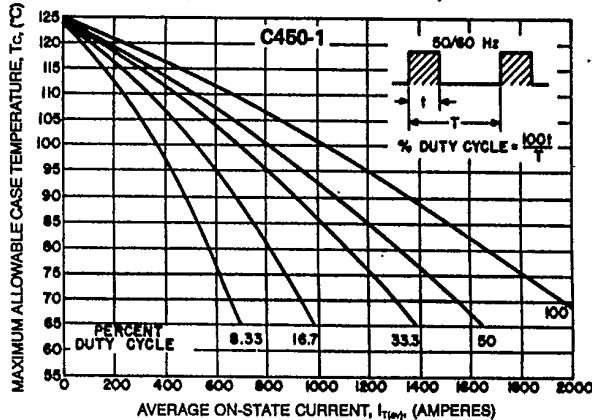

MAXIMUM ON-STATE POWER DISSIPATION (RECTANGULAR WAVEFORM)

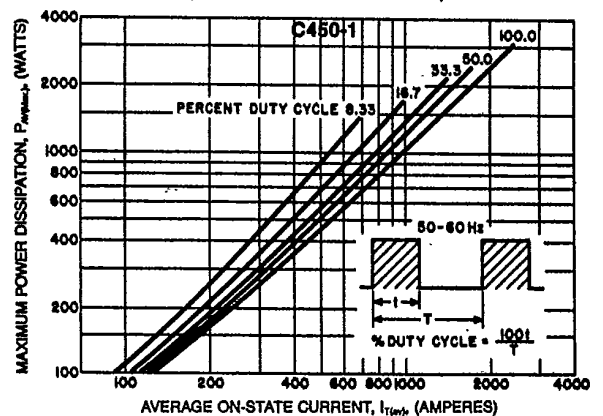



Powerex, Inc., Hillis Street, Youngwood, Pennsylvania 15697 (412) 925-7272  
 Powerex Europe, S.A., 428 Ave. G. Durand, BP107, 72003 LeMans, France (43) 72.75.15

**C450**  
 Phase Control SCR  
 1460-1640 Amperes Avg/500-1400 Volts

MAXIMUM ON-STATE CHARACTERISTICS

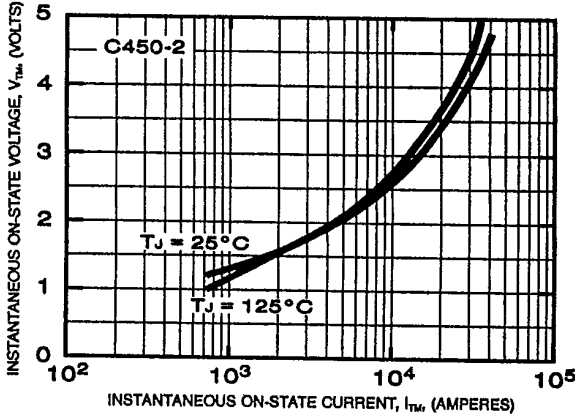

SUB-CYCLE SURGE AND  $I^2t$  RATINGS (RATED LOAD CONDITIONS)

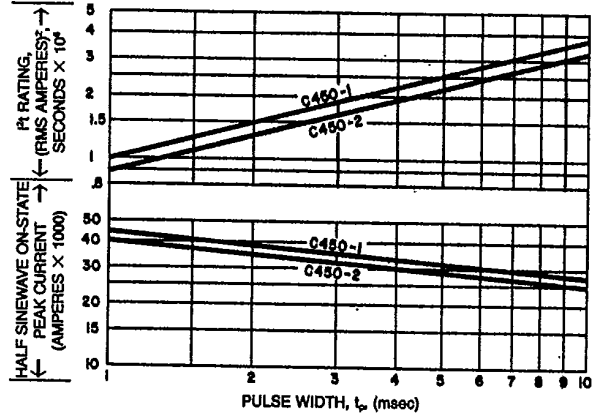

MAXIMUM ALLOWABLE CASE TEMPERATURE (SINUSOIDAL WAVEFORM)

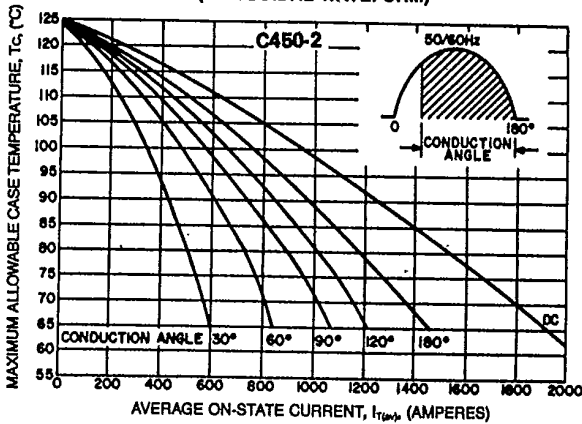

MAXIMUM ON-STATE POWER DISSIPATION (SINUSOIDAL WAVEFORM)

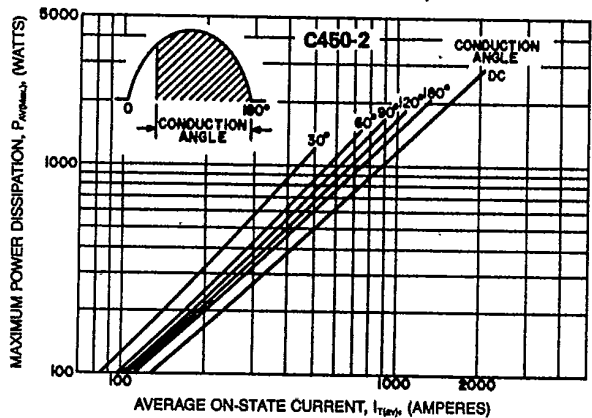

MAXIMUM ALLOWABLE CASE TEMPERATURE (RECTANGULAR WAVEFORM)

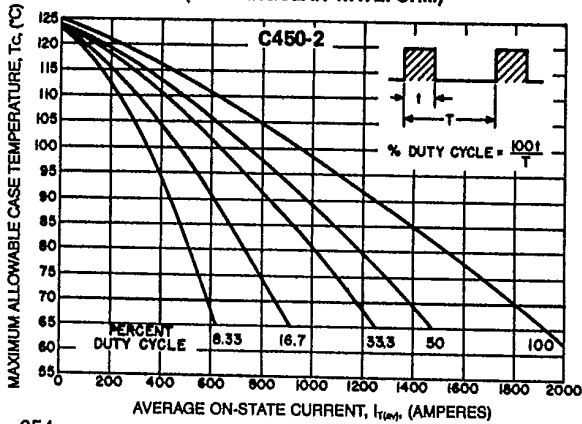

MAXIMUM ON-STATE POWER DISSIPATION (RECTANGULAR WAVEFORM)

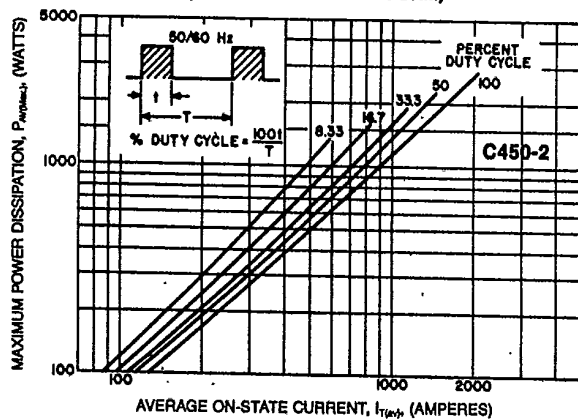



Powerex, Inc., Hillis Street, Youngwood, Pennsylvania 15697 (412) 925-7272  
 Powerex Europe, S.A., 428 Ave. G. Durand, BP107, 72003 LeMans, France (43) 72.75.15

**C450**  
 Phase Control SCR  
 1460-1640 Amperes Avg/500-1400 Volts

TYPICAL RECOVERED CHARGE

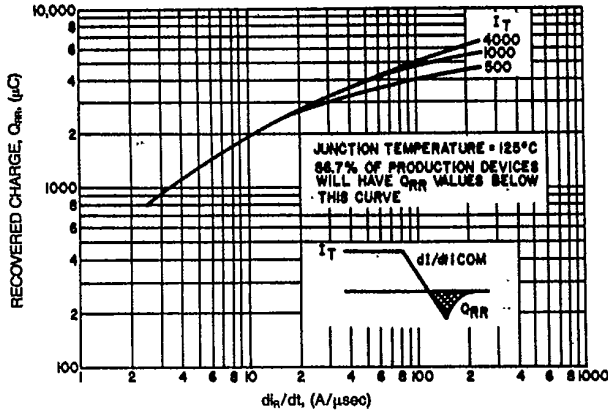

$I_{T(av)}$  vs.  $T_A$  (VARIOUS HEAT EXCHANGERS)

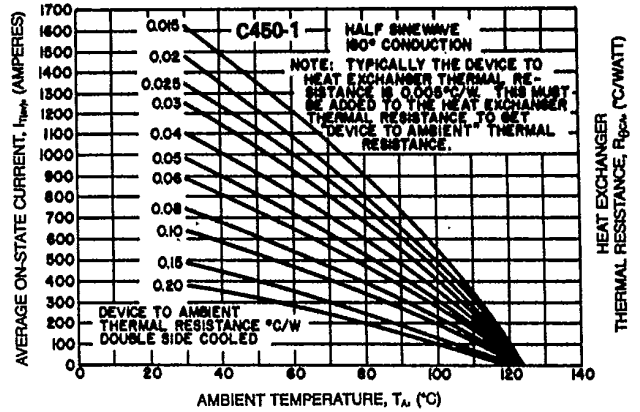

$I_{T(av)}$  vs.  $T_A$  (VARIOUS HEAT EXCHANGERS)

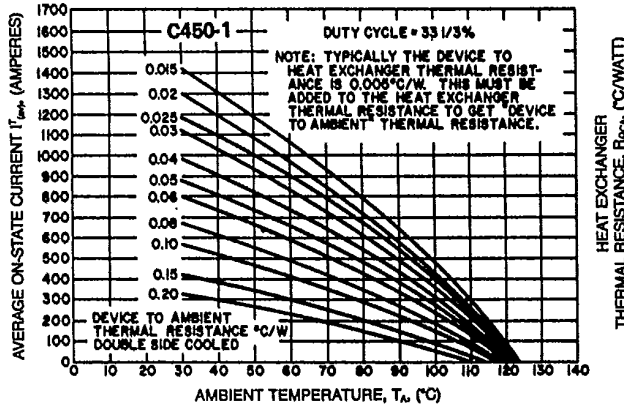

$I_{T(av)}$  vs.  $T_A$  (VARIOUS HEAT EXCHANGERS)

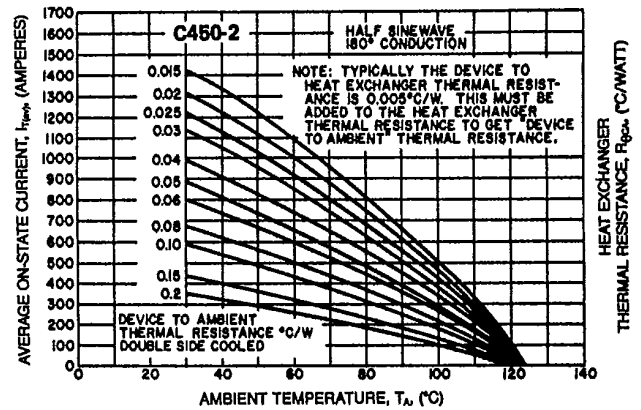

$I_{T(av)}$  vs.  $T_A$  (VARIOUS HEAT EXCHANGERS)

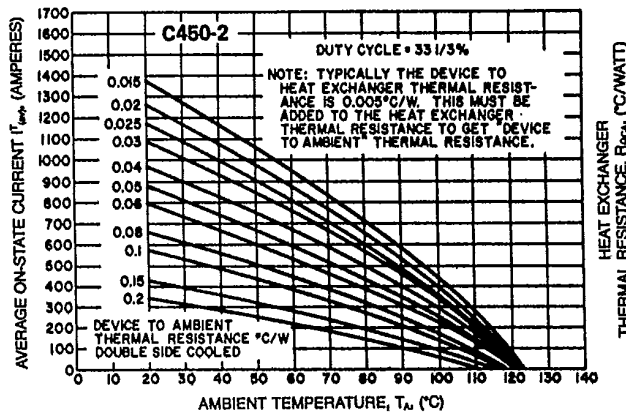

SURGE SUPPRESSION RATING

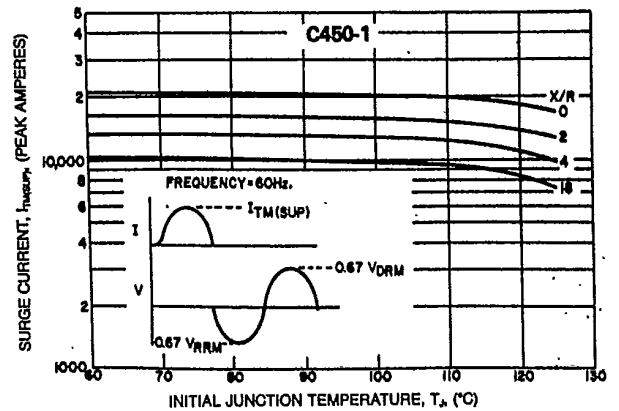



Powerex, Inc., Hillis Street, Youngwood, Pennsylvania 15697 (412) 925-7272

Powerex Europe, S.A., 428 Ave. G. Durand, BP107, 72003 LeMans, France (43) 72.75.15

C450

Phase Control SCR

1460-1840 Amperes Avg/500-1400 Volts

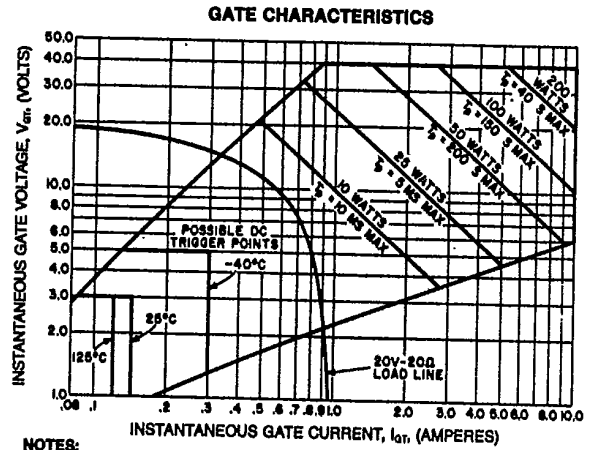
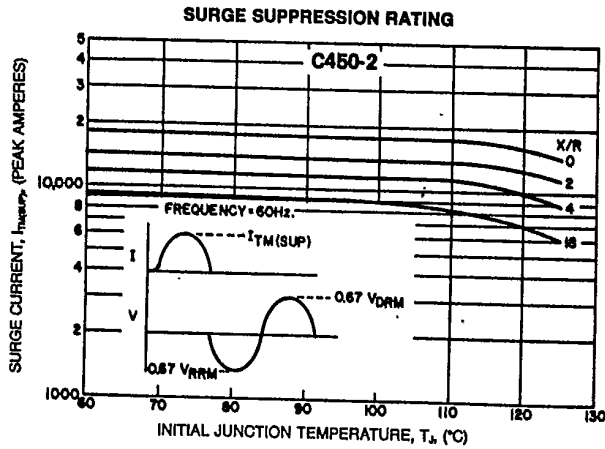

**NOTES:**

1. Maximum allowable average gate dissipation = 5 watts.
2. The locus of possible DC trigger points lies outside the boundaries shown at various case temperatures.
3.  $T_p$  = rectangular gate current pulse width (5μs min. duration, 1.0μs max. rise time).
4. Maximum long-term, repetitive anode  $di/dt$  = 400 Amps/μs with 20V - 20Ω gate source.



LittleDiode supplies new, hard to find or obsolete electronic components and semiconductors all over the world.

With over two million different components listed you are sure to find the part you need.

Feel free to visit us today at our online store:

[LittleDiode.com](http://LittleDiode.com)

Looking forward to providing you with the best possible service.