

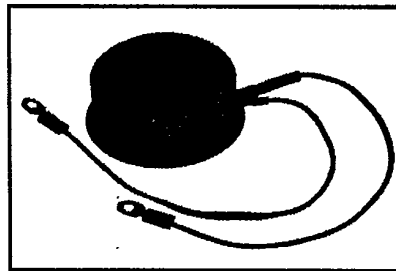

**C451**

Powerex, Inc. Hillis Street, Youngwood, Pennsylvania 15897 (412) 925-7272  
 Powerex Europe, S.A., 428 Ave. G. Durand, BP107, 72003 LeMans, France (43) 72.75.15

**Phase Control SCR**  
 1400-1500 Amperes Avg  
 500-1800 Volts

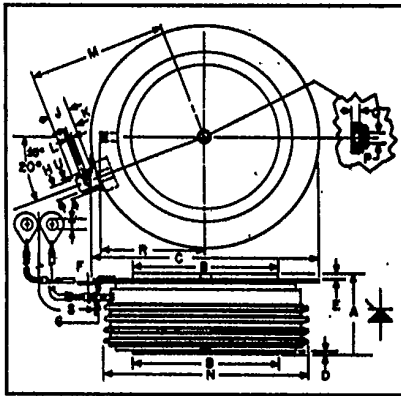

**C451**  
 Phase Control SCR  
 1400-1500 Amperes/500-1800 Volts

**C451**  
 Outline Drawing

Dimensions	Inches		Millimeters	
	Min.	Max.	Min.	Max.
A	1.020	1.065	25.90	27.05
B	1.845	1.855	46.86	47.12
C	—	2.940	—	74.68
D	.030	—	.76	—
E	.050	—	1.27	—
F	.017	.023	.43	.58
G	.057	.059	1.44	1.50
H	.186	.191	4.72	4.85
J	.245	.255	6.22	6.48
K	.115	.130	2.92	3.30
L	.064	.070	1.62	1.78
M	—	1.800	—	45.72
N	—	2.650	—	67.31
P	.135	.145	3.42	3.68
Q	.070	.100	1.77	2.54
R	—	1.355	—	34.42
S	12.219	12.343	310.36	313.51
T	.137	.153	3.47	3.89

**Description**

Powerex Silicon Controlled Rectifiers (SCR) are designed for phase control applications. These are all-diffused, Press-Pak (Pow-R-Disc) devices employing the field-proven amplifying (di/namic) gate.

**Features:**

- Low On-State Voltage
- High di/dt
- High dv/dt
- Hermetic Packaging
- Excellent Surge and I<sup>2</sup>t Ratings

**Applications:**

- Power Supplies
- Battery Chargers
- Motor Control
- Light Dimmers
- VAR Generators

**Ordering Information**

Example: Select the complete six or seven digit part number you desire from the table - i.e. C451M1 is a 600 Volt, 1500 Ampere Phase Control SCR.

Type	Voltage		Current			
	V <sub>onm</sub> V <sub>nom</sub>	Code	I <sub>r</sub> (avg)	Code		
C451	500	E	1500	1		
	600	M			1400	2
	700	S				
	800	N				
	900	T				
	1000	P				
	1100	PA				
	1200	PB				
	1300	PC				
	1400	PD				
	1500	PE				
	1600	PM				
1700	PS					
1800	PN					



Powerex, Inc., Hillis Street, Youngwood, Pennsylvania 15697 (412) 925-7272

Powerex Europe, S.A., 428 Ave. G. Durand, BP107, 72003 LeMans, France (43) 72.75.15

### C451

Phase Control SCR

1400-1500 Amperes Avg/500-1800 Volts

### Absolute Maximum Ratings

	Symbol	C451-1	C451-2	Units
RMS On-State Current	$I_{T(RMS)}$	2350	2200	Amperes
Average On-State Current	$I_{T(av)}$	1500	1400	Amperes
Peak One-Cycle Surge (Non Repetitive) On-State Current (60Hz)	$I_{TSM}$	23,000	21,000	Amperes
Peak One-Cycle Surge (Non-Repetitive) On-State Current (50Hz)	$I_{TSM}$	20,800	19,200	Amperes
Critical Rate-of-Rise of On-State Current (Non-Repetitive)	$di/dt$	400	400	Amperes/ $\mu$ s
Critical Rate-of-Rise of On-State Current (Repetitive)	$di/dt$	75	75	Amperes/ $\mu$ s
$I^2t$ (for Fusing), One Cycle at 60Hz	$I^2t$	2,200,000	1,830,000	$A^2$ sec
Peak Gate Power Dissipation	$P_{GM}$	200	200	Watts
Average Gate Power Dissipation	$P_{G(av)}$	5	5	Watts
Storage Temperature	$T_{STG}$	-40 to 150	-40 to 150	$^{\circ}$ C
Operating Temperature	$T_J$	-40 to 125	-40 to 125	$^{\circ}$ C
Mounting Force <sup>Ⓞ</sup>		5500 to 6000	5500 to 6000	lb.
Mounting Force <sup>Ⓞ</sup>		24.5 to 26.7	24.5 to 26.7	kN

### Electrical and Thermal Characteristics

Characteristics	Symbol	Test Conditions	C451-1	C451-2	Units
<b>Current—Conducting State Maximums</b>					
Peak On-State Voltage	$V_{TM}$	$T_J = 25^{\circ}$ C; $I_{TM} = 3000A$ Peak, Duty Cycle $\leq 0.01\%$	1.70	1.90	Volts
C451					
<b>Voltage—Blocking State Maximums</b>					
Forward Leakage, Peak	$I_{DFM}$	$T_J = 125^{\circ}$ C, $V = V_{DFM}$	45		mA
Reverse Leakage, Peak	$I_{RRM}$	$T_J = 125^{\circ}$ C, $V = V_{RRM}$	45		mA
<b>Switching</b>					
Typical Turn-Off Time	$t_q$	$T_J = 125^{\circ}$ C, $I_T = 2000A$ , Pulse Width = 1000 $\mu$ sec; $V_R = 50V$ ; $dv/dt = 200 V/\mu$ sec; Linear to $.8 V_{DRM}$ ; $di_R/dt = 25A/\mu$ sec; $V_G = 0$ , $R_L = 100\Omega$	150		$\mu$ sec
Typical Delay Time	$t_d$	$T_J = 25^{\circ}$ C, $I_T = 50A$ , Gate Supply = 20V; $R_L = 20\Omega$ ; Rise Time = 0.1/ $\mu$ sec		.7	$\mu$ sec
Min. Critical $dv/dt$ exponential to $V_{DRM}$	$dv/dt$	$T_J = 125^{\circ}$ C, 0.8 $V_{DRM}$ Applied	400		V/ $\mu$ sec
<b>Thermal</b>					
Maximum Thermal Resistance, <sup>Ⓞ</sup> double sided cooling Junction to Case	$R_{\theta JC}$			.025	$^{\circ}$ C/Watt
Case to Sink, Lubricated	$R_{\theta CS}$			.0075	$^{\circ}$ C/Watt
<b>Gate—Maximum Parameters</b>					
Gate Current to Trigger	$I_{GT}$	$T_J = 25^{\circ}$ C, $V_D = 20Vdc$ , $R_L = 3\Omega$	200		mA
Gate Voltage to Trigger	$V_{GT}$	$T_J = -40$ to $125^{\circ}$ C, $V_D = 20Vdc$ , $R_L = 3\Omega$	5		Volts
Non-Triggering Gate Voltage	$V_{GDM}$	$V_D = \text{rated } V_{DRM}$ , $T_J = 125^{\circ}$ C, $R_L 1000\Omega$	.15		Volts
Peak Forward Gate Current	$I_{GTM}$		10		Amperes
Peak Reverse Gate Voltage	$V_{GRM}$		5		Volts

<sup>Ⓞ</sup> Consult recommended mounting procedures.



Powerex, Inc., Hillis Street, Youngwood, Pennsylvania 15697 (412) 925-7272  
 Powerex Europe, S.A., 428 Ave. G. Durand, BP107, 72003 LeMans, France (43) 72.75.15

**C451**  
 Phase Control SCR  
 1400-1500 Amperes Avg/500-1800 Volts

MAXIMUM ON-STATE CHARACTERISTICS

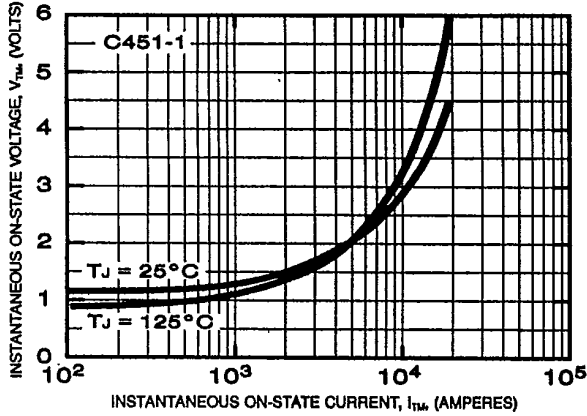

TRANSIENT THERMAL IMPEDANCE CHARACTERISTICS (JUNCTION TO CASE)

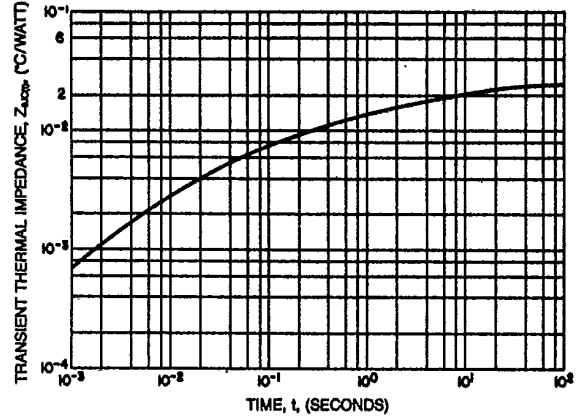

MAXIMUM ALLOWABLE CASE TEMPERATURE (SINUSOIDAL WAVEFORM)

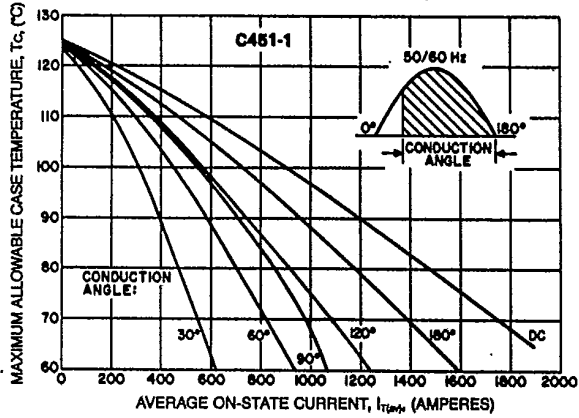

MAXIMUM ON-STATE POWER DISSIPATION (SINUSOIDAL WAVEFORM)

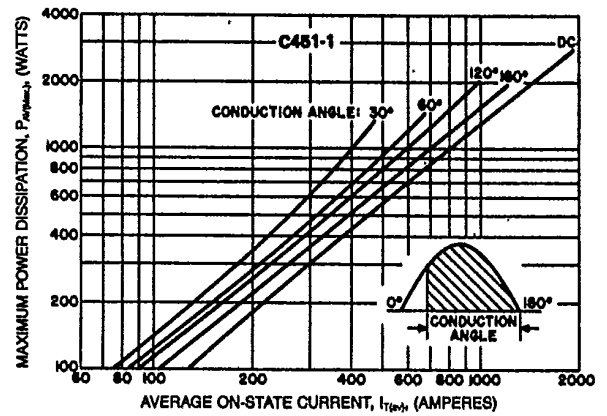

MAXIMUM ALLOWABLE CASE TEMPERATURE (RECTANGULAR WAVEFORM)

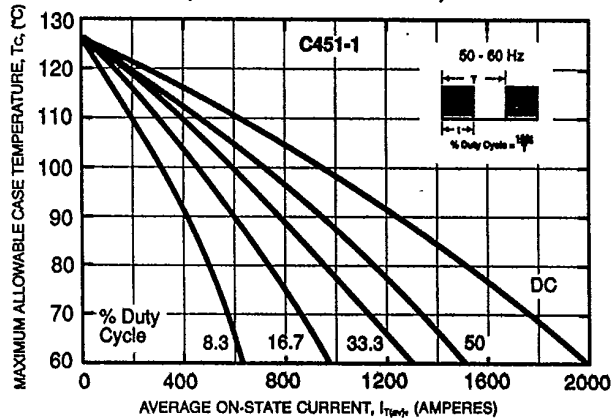

MAXIMUM ON-STATE POWER DISSIPATION (RECTANGULAR WAVEFORM)

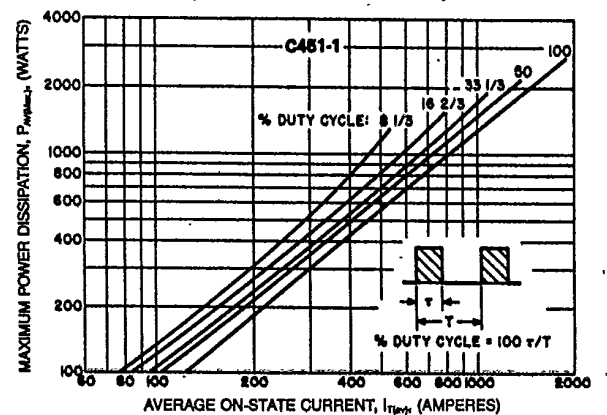



Powerex, Inc., Hillis Street, Youngwood, Pennsylvania 15697 (412) 925-7272  
 Powerex Europe, S.A., 428 Ave. G. Durand, BP107, 72003 LeMans, France (43) 72.75.15

**C451**  
 Phase Control SCR  
 1400-1500 Amperes Avg/500-1800 Volts

MAXIMUM ON-STATE CHARACTERISTICS

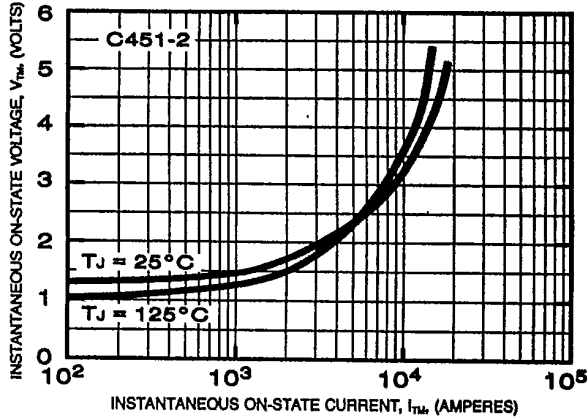

TRANSIENT THERMAL IMPEDANCE CHARACTERISTICS (JUNCTION TO CASE)

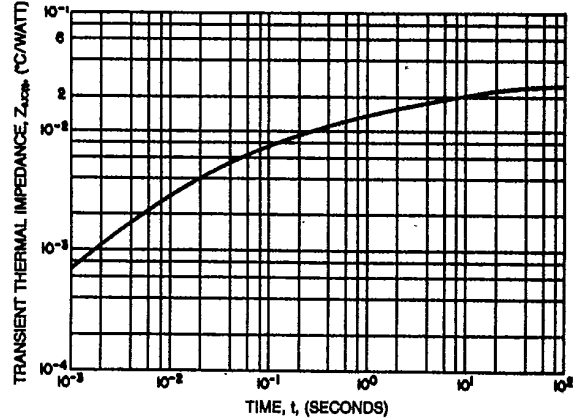

MAXIMUM ALLOWABLE CASE TEMPERATURE (SINUSOIDAL WAVEFORM)

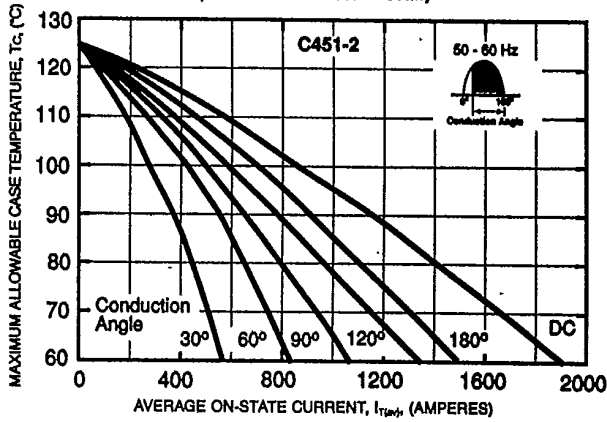

MAXIMUM ON-STATE POWER DISSIPATION (SINUSOIDAL WAVEFORM)

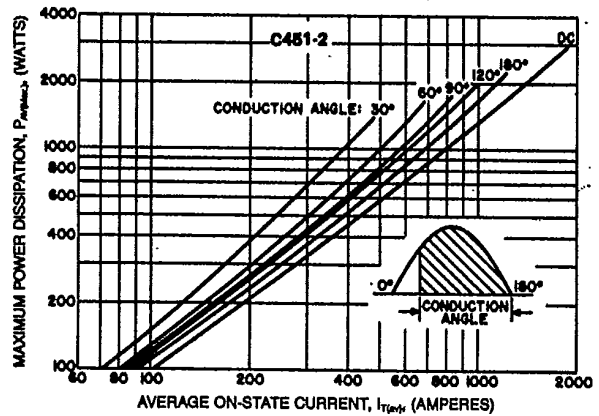

MAXIMUM ALLOWABLE CASE TEMPERATURE (RECTANGULAR WAVEFORM)

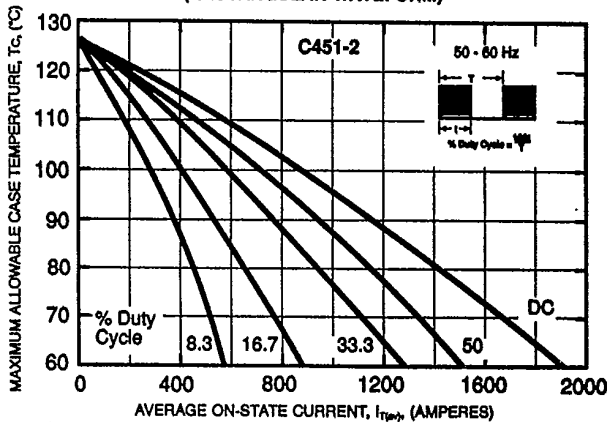

MAXIMUM ON-STATE POWER DISSIPATION (RECTANGULAR WAVEFORM)

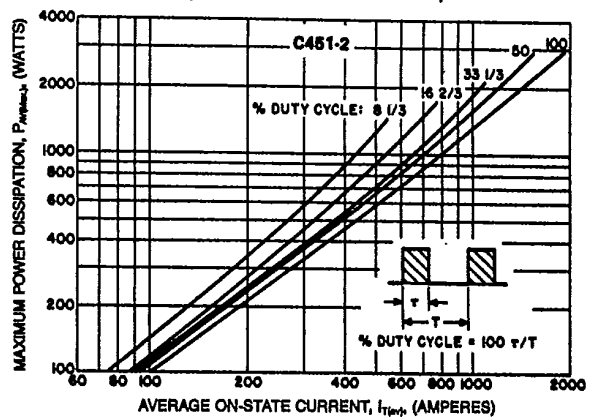



Powerex, Inc., Hillis Street, Youngwood, Pennsylvania 15697 (412) 925-7272  
 Powerex Europe, S.A., 428 Ave. G. Durand, BP107, 72003 LeMans, France (43) 72.75.15

**C451**  
**Phase Control SCR**  
 1400-1500 Amperes Avg/500-1800 Volts

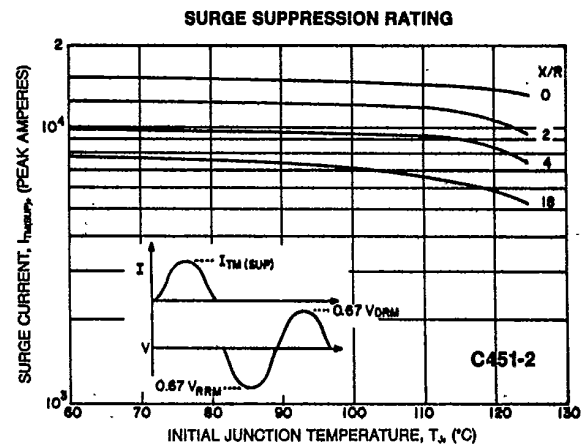
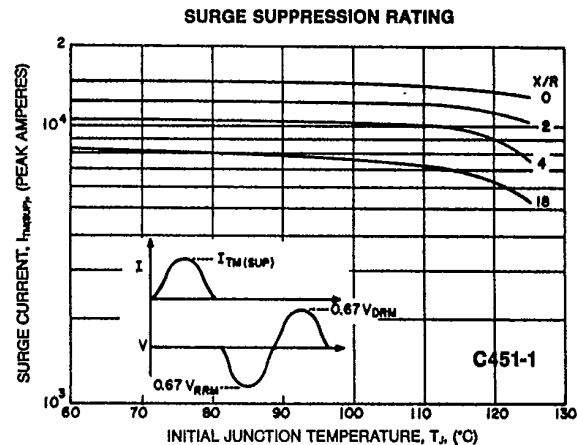
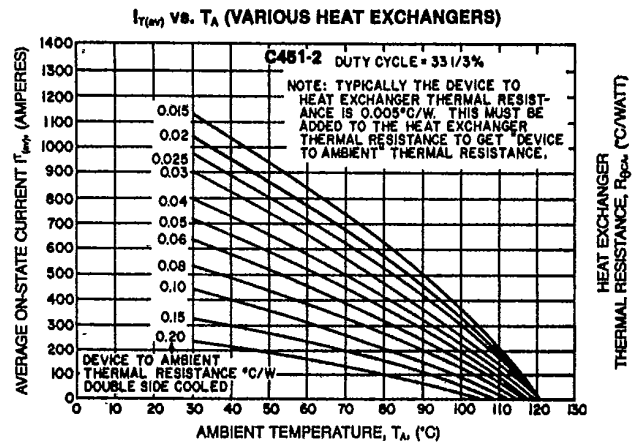
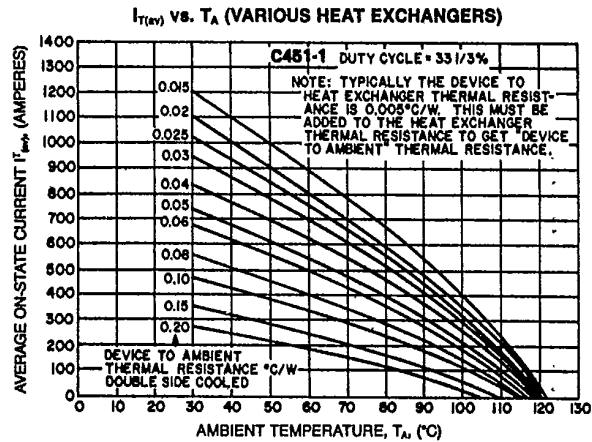
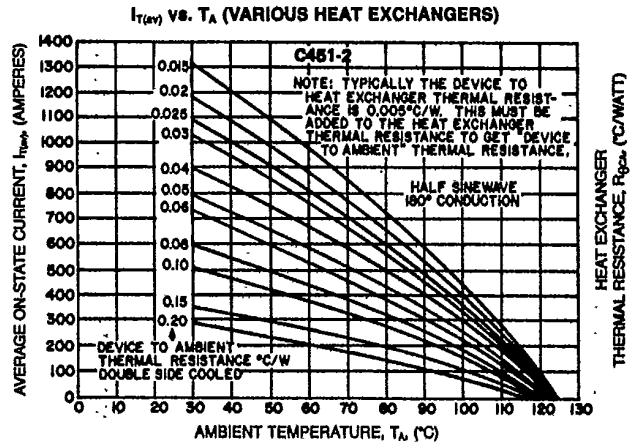
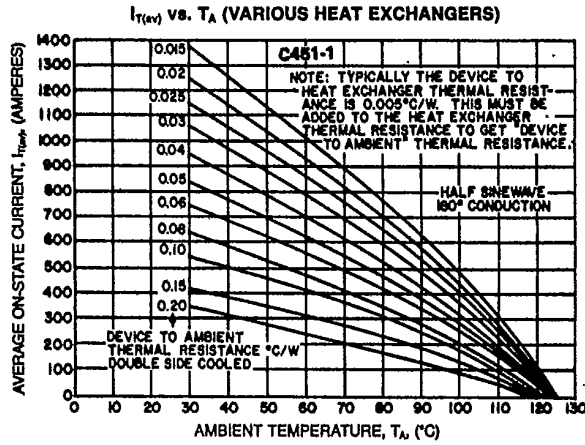



Powerex, Inc., Hillis Street, Youngwood, Pennsylvania 15697 (412) 925-7272

Powerex Europe, S.A., 428 Ave. G. Durand, BP107, 72003 LeMans, France (43) 72.75.15

**C451**

**Phase Control SCR**

1400-1500 Amperes Avg/500-1800 Volts

**TYPICAL RECOVERY CURRENT**

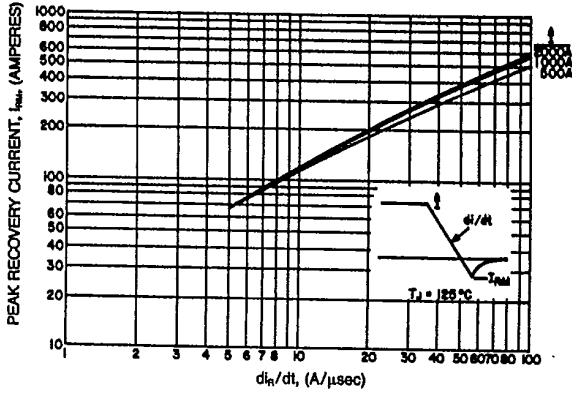

**SUB-CYCLE SURGE AND I<sub>T</sub> RATINGS (RATED LOAD CONDITIONS)**

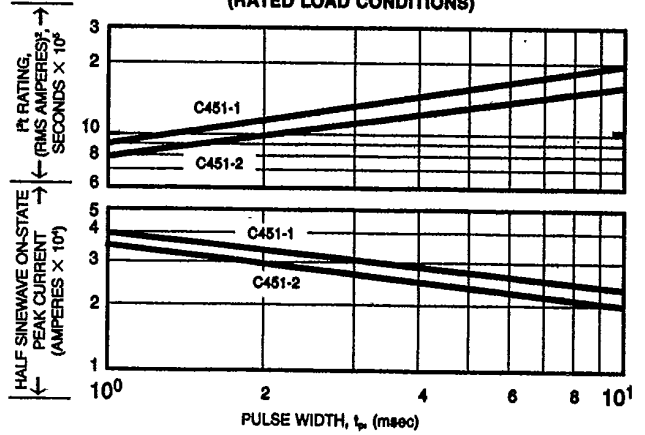

**GATE CHARACTERISTICS**

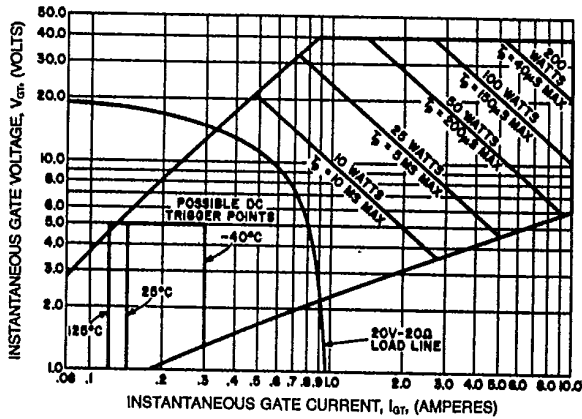

**NOTES:**

1. Maximum allowable average gate dissipation = 5 watts.
2. The locus of possible dc trigger points lies outside the boundaries shown at various case temperatures.
3.  $t_p$  = rectangular gate current pulse width (5  $\mu$ s min. duration, 1  $\mu$ s max. rise time).
4. Maximum long-term, repetitive anode  $di/dt$  = 75 amps/ $\mu$ s with 20V-20 $\Omega$  gate source.



LittleDiode supplies new, hard to find or obsolete electronic components and semiconductors all over the world.

With over two million different components listed you are sure to find the part you need.

Feel free to visit us today at our online store:

[LittleDiode.com](http://LittleDiode.com)

Looking forward to providing you with the best possible service.