

FM / TV front end

BA4425F

The BA4425F is a monolithic IC designed for FM front end use. It consists of an RF amplifier circuit, mixer circuit, oscillation circuit, and IF buffer amplifier.

●Applications

FM radios
Radio cassette players
Home stereos
Headphone stereos

●Features

- 1) Uses double balance mixer to improve intermodulation characteristics.
- 2) Includes a clamp diode in the mixer output.
- 3) Local oscillation buffer on-chip for improved response to strong input.
- 4) The output impedance of the IF buffer is matched with the ceramic filter impedance at 330Ω.
- 5) Mixer input coupling capacitor included on-chip.
- 6) Includes a feedback capacitor for the local oscillation circuit.
- 7) Reception of VHF terrestrial TV channels is possible.
- 8) Compact SOP 8-pin package.

●Absolute maximum ratings (Ta = 25°C)

Parameter	Symbol	Limits	Unit
Power supply voltage	Vcc	7.0	V
Power dissipation*	Pd	500*	mW
Operating temperature	Topr	-25~+75	°C
Storage temperature	Tstg	-55~+125	°C

* Reduced by 5.0mW for each increase in Ta of 1°C over 25°C.

●Recommended operating conditions (Ta = 25°C)

Parameter	Symbol	Limits	Unit
Power supply voltage*	Vcc	1.6~6.0	V

* For basic operation at Ta = 25°C.

●Block diagram

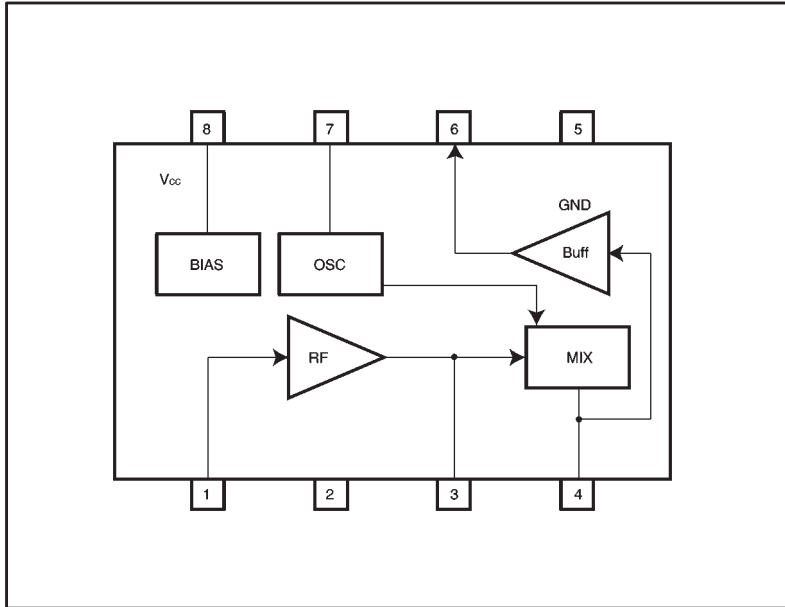

●Pin descriptions

Pin No.	Pin name	Function
1	FM antenna input pin	Connect to BPF, etc. $Z_{IN} = 75 \Omega$
2	RF amplifier bypass pin	Connect to bypass capacitor
3	RF amplifier output load pin	Connect to RF tuning circuit
4	MIX output pin	Connect to IFT or resistor load
5	GND pin	Ground pin of IC
6	IF buffer output pin	$Z_{OUT} = 330 \Omega$
7	OSC pin	Connect to station resonance circuit
8	V _{CC} pin	Voltage supply pin of IC



●Electrical characteristics (unless otherwise noted, T_a = 25°C and V_{CC} = 4.0V)

Parameter	Symbol	Min.	Typ.	Max.	Unit	Conditions	Measurement circuit
Quiescent current	I _Q	2.6	4.5	7.2	mA	No input	Fig.1
Output saturation voltage	V _O	30	50	72	mV _{rms}	f _d =98MHz, 80dB μ V	Fig.1
Local oscillator voltage	V _{OSC}	200	400	630	mV _{rms}	f _{OSC} =108MHz, R ₇ =0 Ω	Fig.1
Voltage conversion gain	G _{VC}	31	36	42	dB	f _d =98MHz, 55dB μ V	Fig.1
Local oscillation stop voltage	V _{STOP}	—	0.9	1.2	V	R ₇ =0 Ω	Fig.1

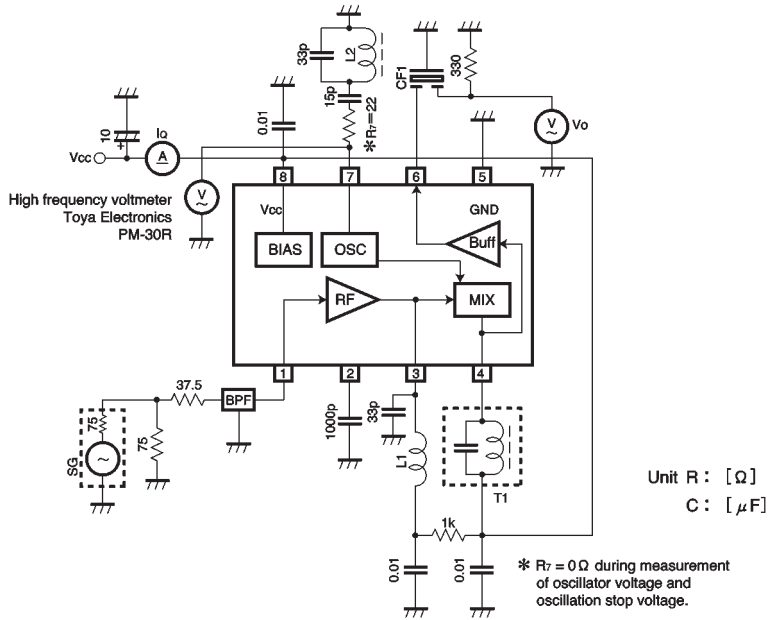
● Measurement circuit

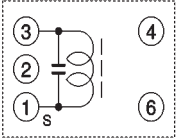

●Component data

Component number	Component name	Product number / manufacturer	Remarks
Z1	Band-pass filter	BPMB6A Soshin	88~108MHz Z _{in} =75Ω, Z _{out} =75Ω
L1	RF coil	FEM10C-2F6 Sumida	 <p>①-③ 2½-T Wire type: φ 0.6UEW No load: Q = 115</p>
L2	OSC coil	FEM10C-2F6 Sumida	 <p>①-③ 2½-T Wire type: φ 0.6UEW No load: Q = 115</p>
T1	IFT	2158-4095-498 Sumida	 <p>①-③ 13T Wire type: φ 0.10UEW</p> <p>Tuning frequency: 10.7 MHz ± 3% or higher, variable No load: Q = 70 or higher (10.7 MHz) Tuning capacitance: 82pF ± 10%</p>
CF1	FM ceramic filter	SFE10.7MA5-A Murata	3 dB bandwidth = 280 kHz ± 50 kHz

●Electrical characteristic curves

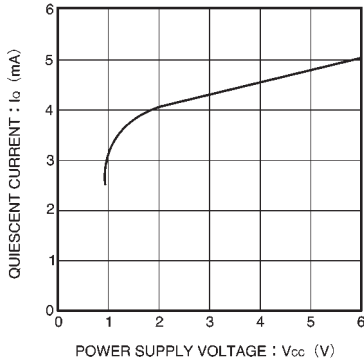

Fig. 1 Quiescent current vs. power supply voltage

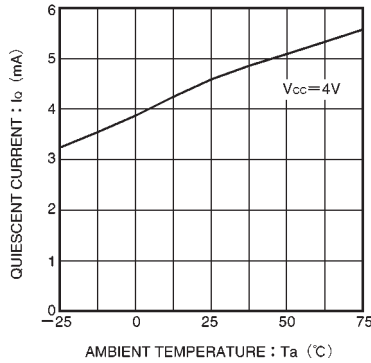

Fig. 2 Quiescent current vs. ambient temperature

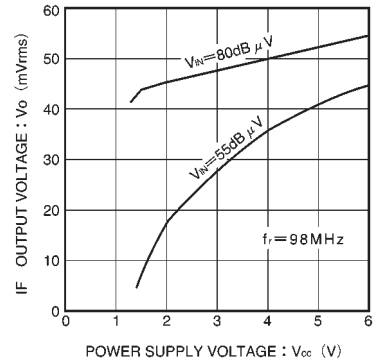

Fig. 3 IF output voltage vs. power supply voltage

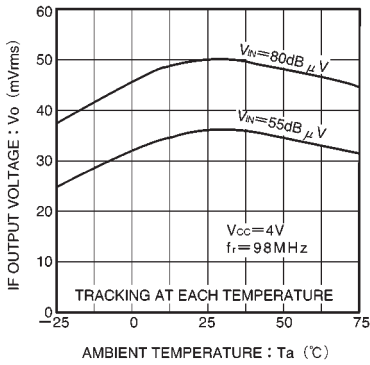

Fig. 4 IF output voltage vs. ambient temperature

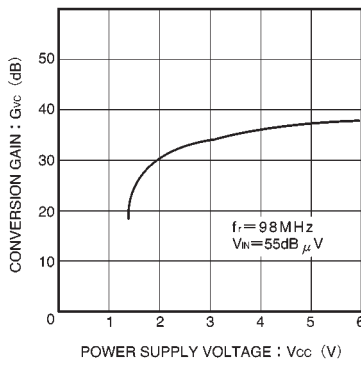

Fig. 5 Voltage conversion gain vs. power supply voltage

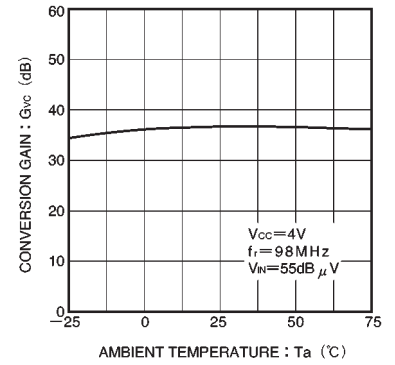

Fig. 6 Voltage conversion gain vs. ambient temperature

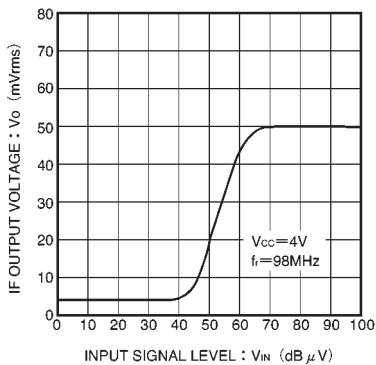

Fig. 7 IF output voltage vs. input signal level

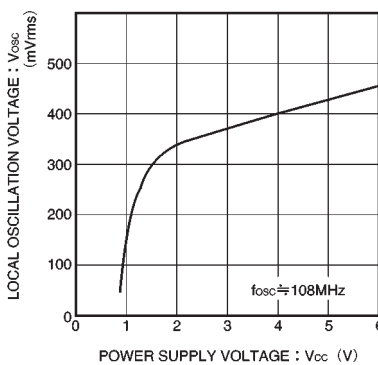

Fig. 8 Local oscillation voltage vs. power supply voltage

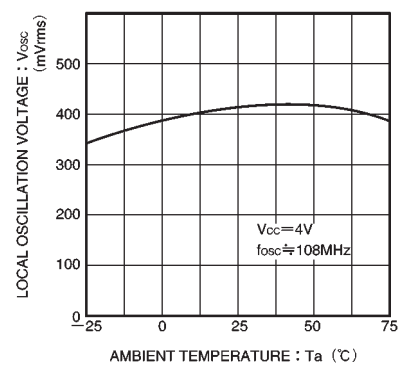

Fig. 9 Local oscillation voltage vs. ambient temperature

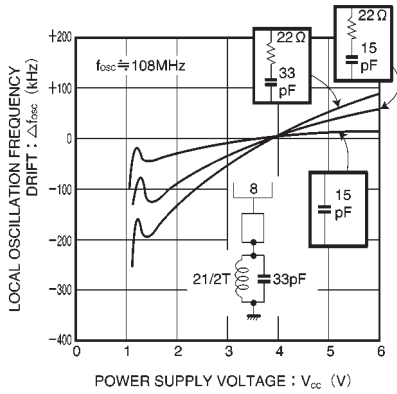

Fig. 10 Local oscillation frequency vs. power supply voltage

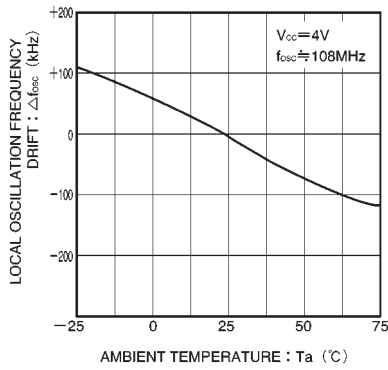
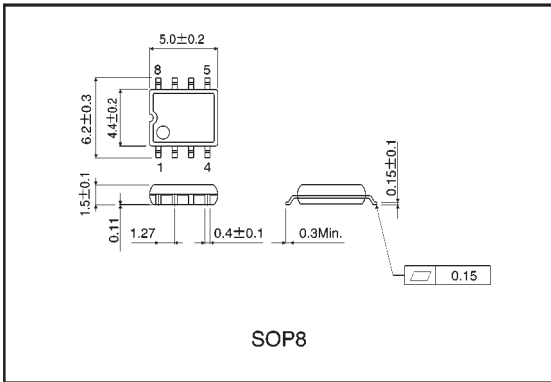

Fig. 11 Local oscillation frequency vs. ambient temperature

● External dimensions (Units: mm)





LittleDiode supplies new, hard to find or obsolete electronic components and semiconductors all over the world.

With over two million different components listed you are sure to find the part you need.

Feel free to visit us today at our online store:

LittleDiode.com

Looking forward to providing you with the best possible service.