

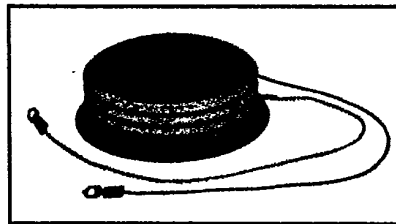

C781

Powerex, Inc. Hills Street, Youngwood, Pennsylvania 15897 (412) 925-7272
 Powerex Europe, S.A., 428 Ave. G. Durand, BP107, 72003 LeMans, France (43) 72.75.15

Phase Control SCR
 2500 Amperes Avg
 1600-2100 Volts

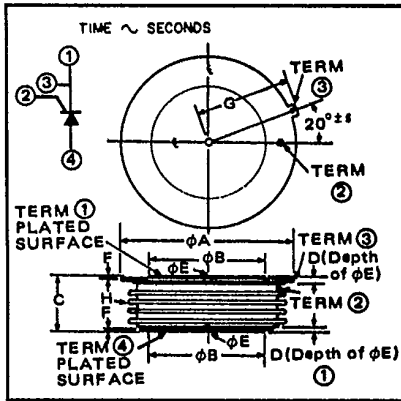

C781
Phase Control SCR
 2500 Amperes/1600-2100 Volts

C781
Outline Drawing

Dimensions	Inches		Millimeters	
	Min.	Max.	Min.	Max.
ϕA	—	4.350	—	110.49
ϕB	2.876	2.830	73.05	73.15
C	1.387	1.447	35.23	36.75
D	.080	—	2.03	—
ϕE	0.136	0.146	3.45	3.71
F	0.20	—	5.08	—
G	2.403	2.418	61.16	61.42
H	—	—	—	—

Description

Powerex Silicon Controlled Rectifiers (SCR) are designed for phase control applications. These are all-diffused, Press-Pak (Pow-R-Disc) devices employing the field-proven amplifying (di/namic) gate.

Features:

- Low On-State Voltage
- High di/dt
- High dv/dt
- Hermetic Packaging
- Excellent Surge and I²t Ratings

Applications:

- Power Supplies
- Battery Chargers
- Motor Control
- Light Dimmers
- VAR Generators

Ordering Information

Example: Select the complete five or six digit part number you desire from the table - i.e. C781L is a 2000 Volt, 2500 Ampere Phase Control SCR.

Type	Voltage		Current
	V _{ORM}	Code	
C781	1600	PM	2500
	1700	PS	
	1800	PN	
	1900	PT	
	2000	L	
	2100	LA	



Powerex, Inc., Hillis Street, Youngwood, Pennsylvania 15697 (412) 925-7272

Powerex Europe, S.A., 428 Ave. G. Durand, BP107, 72003 LeMans, France (43) 72.75.15

C781

Phase Control SCR

2500 Amperes Avg/1600-2100 Volts

Absolute Maximum Ratings

	Symbol	C781	Units
RMS On-State Current	$I_{T(RMS)}$	3925	Amperes
Average On-State Current	$I_{T(av)}$	2500	Amperes
Peak One-Cycle Surge (Non-Repetitive) On-State Current (60Hz)	I_{TSM}	45,000	Amperes
Peak One-Cycle Surge (Non-Repetitive) On-State Current (50Hz)	I_{TSM}	41,500	Amperes
Critical Rate-of-Rise of On-State Current (Non-Repetitive)	di/dt	600	Amperes/ μ s
Critical Rate-of-Rise of On-State Current (Repetitive)	di/dt	100	Amperes/ μ s
I^2t (for Fusing), One Cycle at 60Hz	I^2t	8.5×10^6	A ² sec
Peak Gate Power Dissipation, 100 microseconds	P_{GM}	250	Watts
Average Gate Power Dissipation	$P_{G(av)}$	35	Watts
Storage Temperature	T_{STG}	-40 to 150	°C
Operating Temperature	T_J	-40 to 125	°C
Mounting Force [Ⓞ]		9000 to 10,000	lb.
Mounting Force [Ⓞ]		40 to 44.5	kN

Electrical and Thermal Characteristics

Characteristics	Symbol	Test Conditions	C781	Units
Voltage—Blocking State Maximums				
Forward Leakage, Peak	I_{DRM}	$T_J = 125^\circ\text{C}, V_{DRM} = \text{Rated}$	150	mA
Reverse Leakage, Peak	I_{RRM}	$T_J = 125^\circ\text{C}, V_{RRM} = \text{Rated}$	150	mA
Current—Conducting State Maximums				
Peak On-State Voltage	V_{TM}	$T_J = 125^\circ\text{C}, I_{TM} = 2000\text{A}$	1.20	Volts
Switching				
Typical Turn-Off Time	t_q	$T_J = 125^\circ\text{C}, I_T = 2000\text{A}$ $t_p > 3\text{ms}$ $di_R/dt = 5\text{A } \mu\text{s}$ $V_R = 100\text{V}$ $dv/dt = 1000\text{V } \mu\text{s}$ $V \text{ reapplied} = 1000\text{V}$	250	μsec
Typical Delay Time	t_d	$T_J = 125^\circ\text{C}, V_D = 1500\text{V}$	3	μsec
Min. Critical dv/dt exponential to V_{DRM}	dv/dt	$T_J = 125^\circ\text{C}, V_D = .8V_{DRM}$	500	V/ μsec
Thermal				
Maximum Thermal Resistance, [Ⓞ] double sided cooling				
Junction to Case	$R_{\theta JC}$.012	°C/Watt
Case to Sink, Lubricated	$R_{\theta CS}$.002	°C/Watt
Gate—Maximum Parameters				
Gate Current to Trigger	I_{GT}	$T_J = 25^\circ\text{C}, V_D = 12\text{Vdc}$	250	mA
Gate Voltage to Trigger	V_{GT}	$T_J = 25^\circ\text{C}, V_D = 12\text{Vdc}$	4.2	Volts
Non-Triggering Gate Voltage	V_{GDM}	$T_J = 125^\circ\text{C}, V_D = 1000\text{V}$.5	Volts
Peak Forward Gate Current	I_{GTM}		20	Amperes
Peak Reverse Gate Voltage	V_{GRM}		20	Volts

[Ⓞ] Consult recommended mounting procedures.



Powerex, Inc., Hillis Street, Youngwood, Pennsylvania 15697 (412) 925-7272
 Powerex Europe, S.A., 428 Ave. G. Durand, BP107, 72003 LeMans, France (43) 72.75.15

C781
 Phase Control SCR
 2500 Amperes Avg/1600-2100 Volts

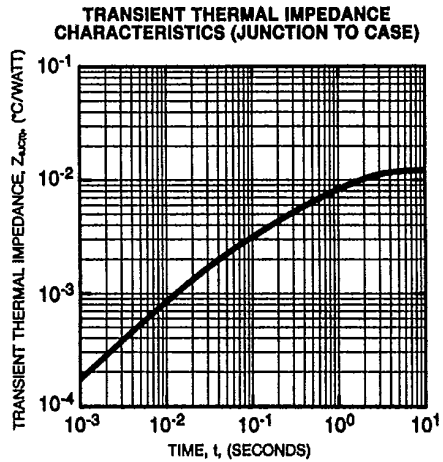
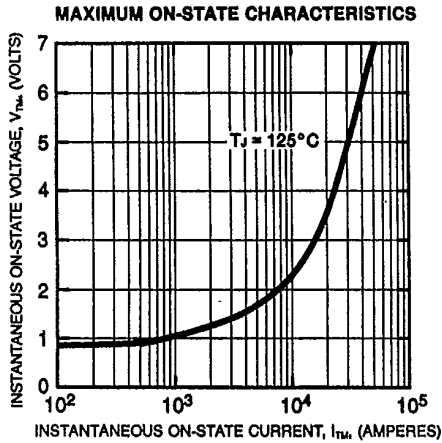

- NOTES:**
- Add .002°C/W to account for both case to dissipator interfaces when properly mounted; e.g. $R_{\theta jc} = .014^\circ\text{C/W}$. See Mounting Instructions.
 - DC Thermal Impedance is based on average full cycle junction temperature. Instantaneous junction temperature may be calculated using the following modifications:
 - end of conducting portion of cycle
 - 120° sq. wave add .0012°C/W along entire curve
 - 180° sq. wave add .0010°C/W along entire curve
 - 180° sine wave add .0005°C/W along entire curve
 - end of full cycle
 - any wave, subtract .0005°C/W along entire curve
 - Ask for general mounting instructions.

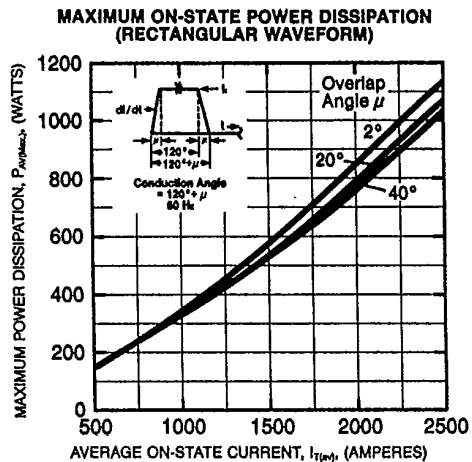
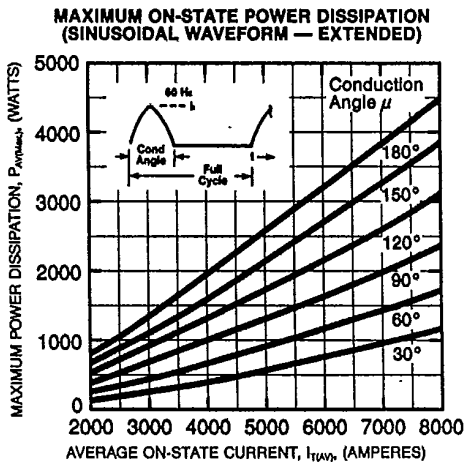
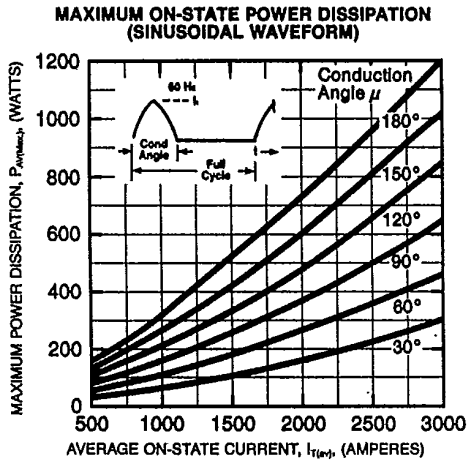



Powerex, Inc., Hillis Street, Youngwood, Pennsylvania 15897 (412) 925-7272

Powerex Europe, S.A., 428 Ave. G. Durand, BP107, 72003 LeMans, France (43) 72.75.15

C781

Phase Control SCR

2500 Amperes Avg/1600-2100 Volts

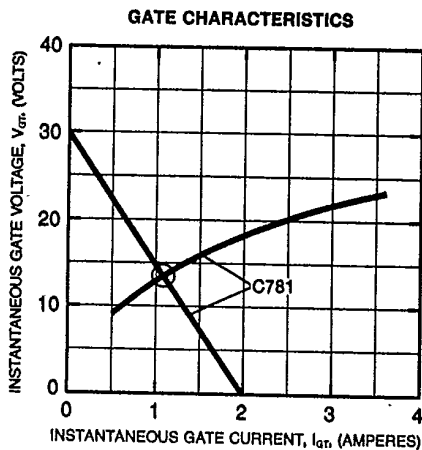
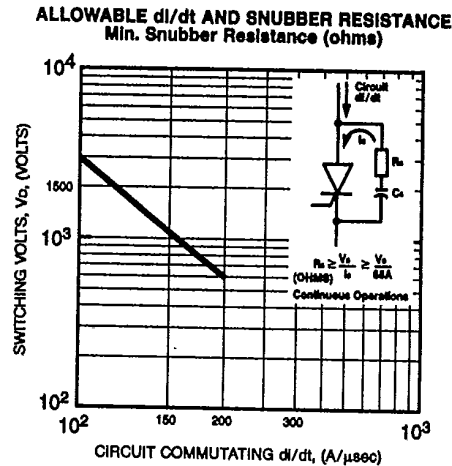
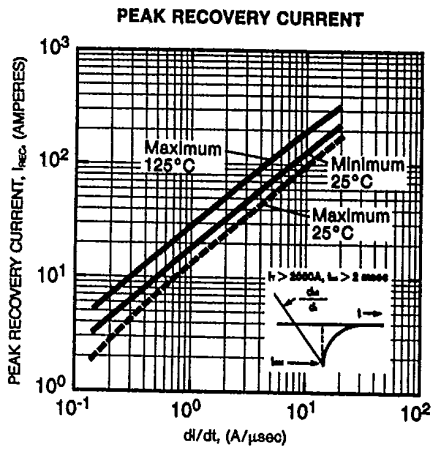
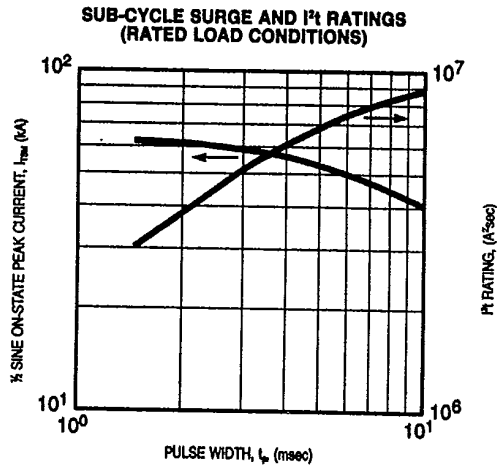
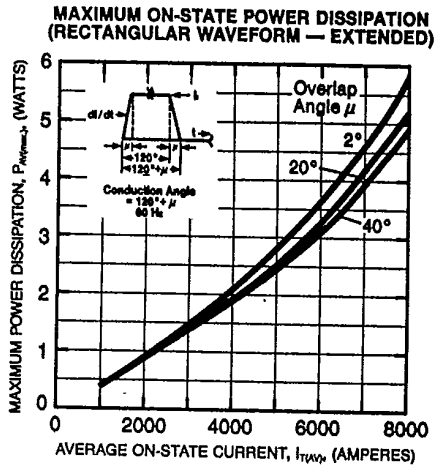

NOTES:

Thyristor Gate Impedance

- This is enhanced by fast rising gate voltage, increasing anode bias and temperature.
- It is at a minimum for dc voltage, zero bias and low temperature (not shown).
- The maximum impedances expected for C784 and C781, C782 are indicated as curves of gate current versus gate voltage.

Gate Supply

- Load lines for 40V/10 Ω and 30V/15 Ω are shown. The short circuit current rise time should be approximately 0.5 μ s and the duration longer than the delay time expected for the thyristor.

Minimum Acceptable Gate Current

- The intersection of load line and gate characteristic (enriched) indicates the minimum value of actual current flowing into the gate that is required during the delay time interval needed for the published dI/dt and snubber discharge ratings.

Additional

- Peak gate power, P_{GAV} (100 μ s) 250W
- Average gate power, P_{GAV} 35W
- Peak gate current 20A
- Peak reverse voltage V_{orv} 30V



LittleDiode supplies new, hard to find or obsolete electronic components and semiconductors all over the world.

With over two million different components listed you are sure to find the part you need.

Feel free to visit us today at our online store:

LittleDiode.com

Looking forward to providing you with the best possible service.