

PNP Silicon Digital Transistor

- Switching circuit, inverter, interface circuit, driver circuit
- Built in bias resistor ($R_1=2.2k\Omega$, $R_2=2.2k\Omega$)

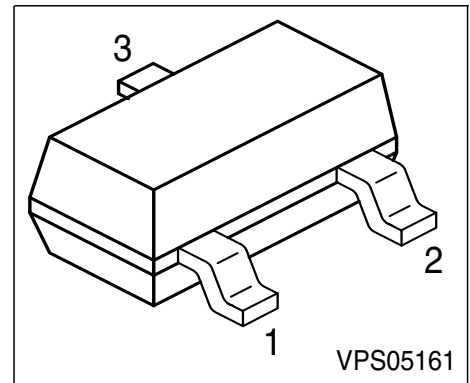
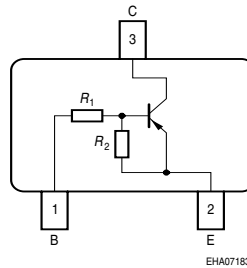

| Type | Marking | Pin Configuration | | | Package |
|--------|---------|-------------------|-------|-------|---------|
| BCR553 | XBs | 1 = B | 2 = E | 3 = C | SOT23 |

Maximum Ratings

| Parameter | Symbol | Value | Unit |
|---|-------------|-------------|------------------|
| Collector-emitter voltage | V_{CEO} | 50 | V |
| Collector-base voltage | V_{CBO} | 50 | |
| Emitter-base voltage | V_{EBO} | 10 | |
| Input on Voltage | $V_{i(on)}$ | 12 | |
| DC collector current | I_C | 500 | mA |
| Total power dissipation, $T_S = 79\text{ }^\circ\text{C}$ | P_{tot} | 330 | mW |
| Junction temperature | T_j | 150 | $^\circ\text{C}$ |
| Storage temperature | T_{stg} | -65 ... 150 | |

Thermal Resistance

| | | | |
|--|------------|------------|-----|
| Junction - soldering point ¹⁾ | R_{thJS} | ≤ 215 | K/W |
|--|------------|------------|-----|

¹For calculation of R_{thJA} please refer to Application Note Thermal Resistance

Electrical Characteristics at $T_A=25^\circ\text{C}$, unless otherwise specified

| Parameter | Symbol | Values | | | Unit |
|--|---------------|--------|------|------|------------|
| | | min. | typ. | max. | |
| DC Characteristics | | | | | |
| Collector-emitter breakdown voltage $I_C = 100 \mu\text{A}, I_B = 0$ | $V_{(BR)CEO}$ | 50 | - | - | V |
| Collector-base breakdown voltage $I_C = 10 \mu\text{A}, I_E = 0$ | $V_{(BR)CBO}$ | 50 | - | - | |
| Collector cutoff current $V_{CB} = 40 \text{ V}, I_E = 0$ | I_{CBO} | - | - | 100 | nA |
| Emitter cutoff current $V_{EB} = 10 \text{ V}, I_C = 0$ | I_{EBO} | - | - | 3.5 | mA |
| DC current gain 1) $I_C = 50 \text{ mA}, V_{CE} = 5 \text{ V}$ | h_{FE} | 40 | - | - | - |
| Collector-emitter saturation voltage1) $I_C = 50 \text{ mA}, I_B = 2.5 \text{ mA}$ | V_{CEsat} | - | - | 0.3 | V |
| Input off voltage $I_C = 100 \mu\text{A}, V_{CE} = 5 \text{ V}$ | $V_{i(off)}$ | 0.6 | - | 1.5 | |
| Input on Voltage $I_C = 10 \text{ mA}, V_{CE} = 0.3 \text{ V}$ | $V_{i(on)}$ | 1 | - | 1.8 | |
| Input resistor | R_1 | 1.5 | 2.2 | 2.9 | k Ω |
| Resistor ratio | R_1/R_2 | 0.9 | 1 | 1.1 | - |
| AC Characteristics | | | | | |
| Transition frequency $I_C = 50 \text{ mA}, V_{CE} = 5 \text{ V}, f = 100 \text{ MHz}$ | f_T | - | 150 | - | MHz |

 1) Pulse test: $t < 300\mu\text{s}$; $D < 2\%$

DC Current Gain $h_{FE} = f(I_C)$

$V_{CE} = 5V$ (common emitter configuration)

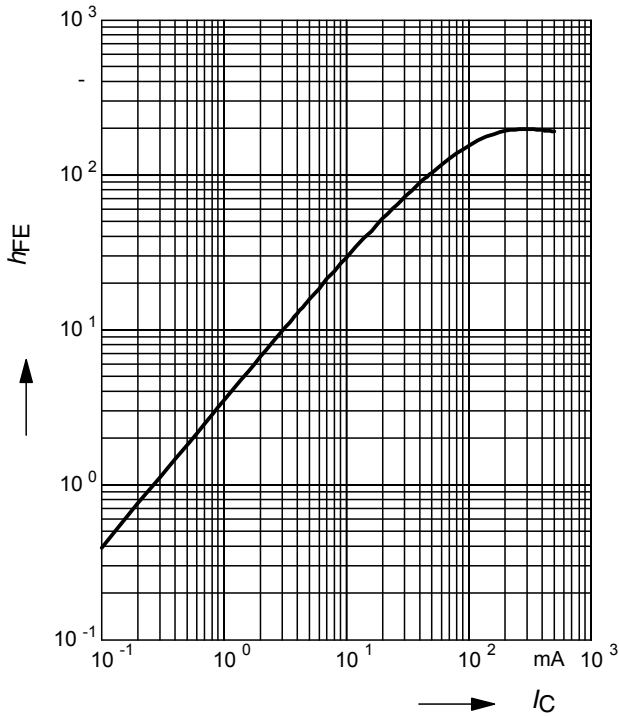

Collector-Emitter Saturation Voltage $V_{CEsat} = f(I_C), h_{FE} = 20$

$V_{CEsat} = f(I_C), h_{FE} = 20$

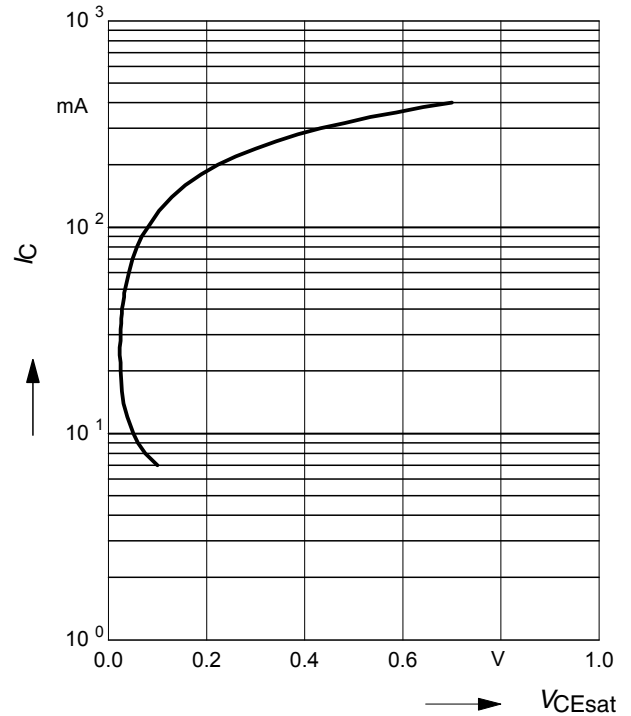

Input on Voltage $V_{i(on)} = f(I_C)$

$V_{CE} = 0.3V$ (common emitter configuration)

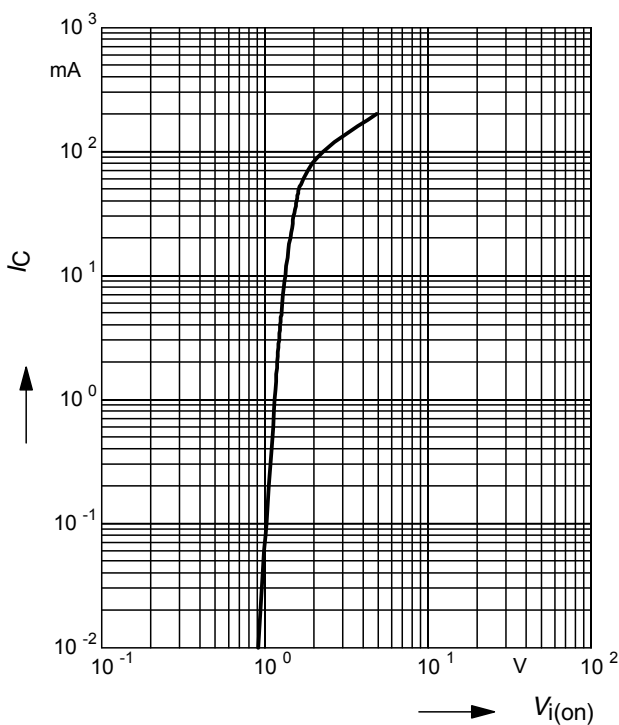

Input off voltage $V_{i(off)} = f(I_C)$

$V_{CE} = 5V$ (common emitter configuration)

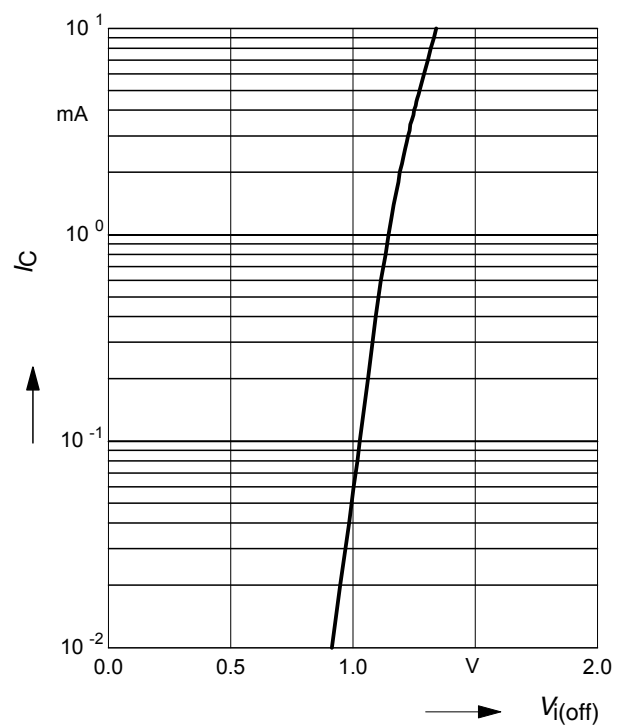

Total power dissipation $P_{tot} = f(T_S)$

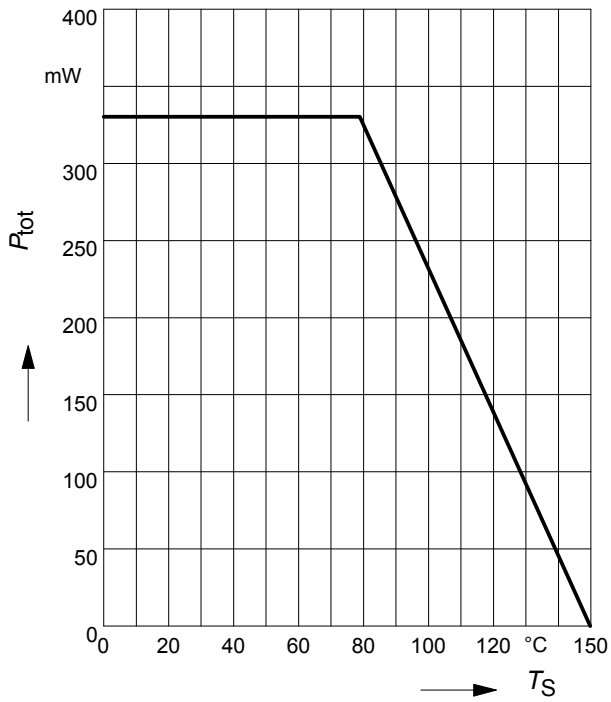

Permissible Pulse Load $R_{thJS} = f(t_p)$

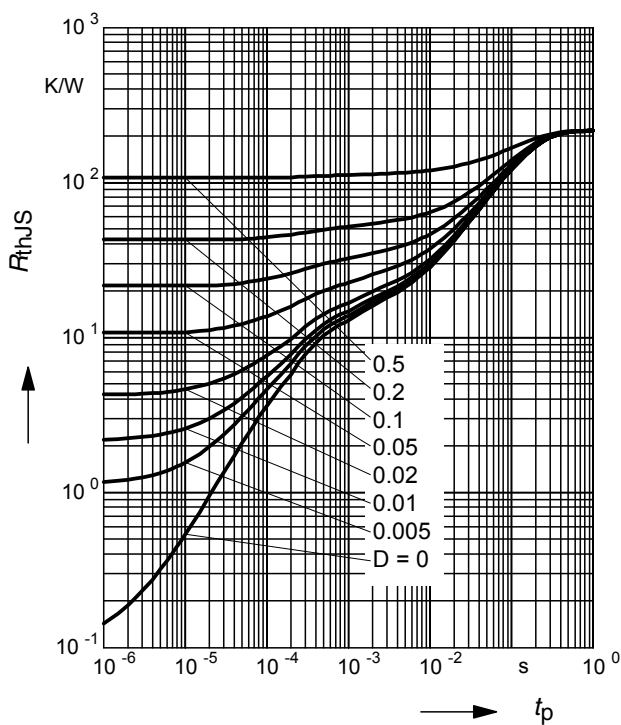

Permissible Pulse Load

$P_{totmax} / P_{totDC} = f(t_p)$

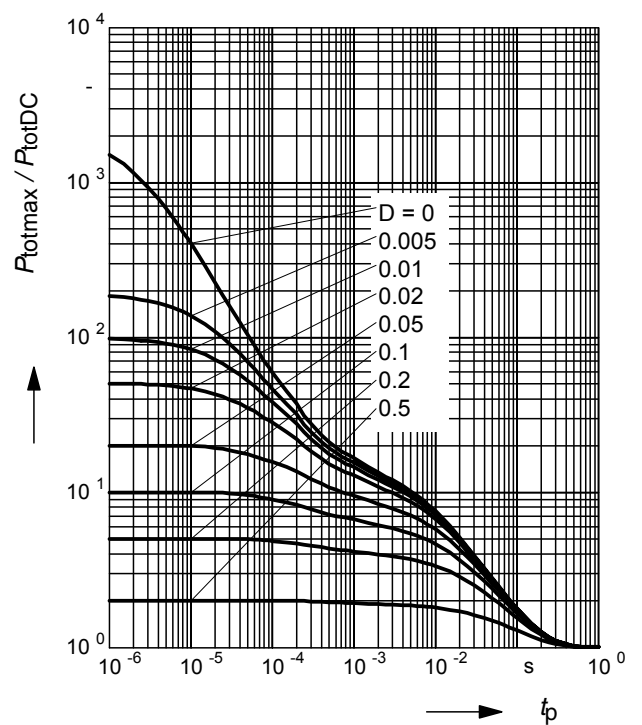



LittleDiode supplies new, hard to find or obsolete electronic components and semiconductors all over the world.

With over two million different components listed you are sure to find the part you need.

Feel free to visit us today at our online store:

LittleDiode.com

Looking forward to providing you with the best possible service.