

Powerex, Inc., 200 Hillis Street, Youngwood, Pennsylvania 15697-1800 (412) 925-7272
 Powerex, Europe, S.A. 428 Avenue G. Durand, BP107, 72003 Le Mans, France (43) 41.14.14

Phase Control SCR
 1000 Amperes Average
 3200 Volts

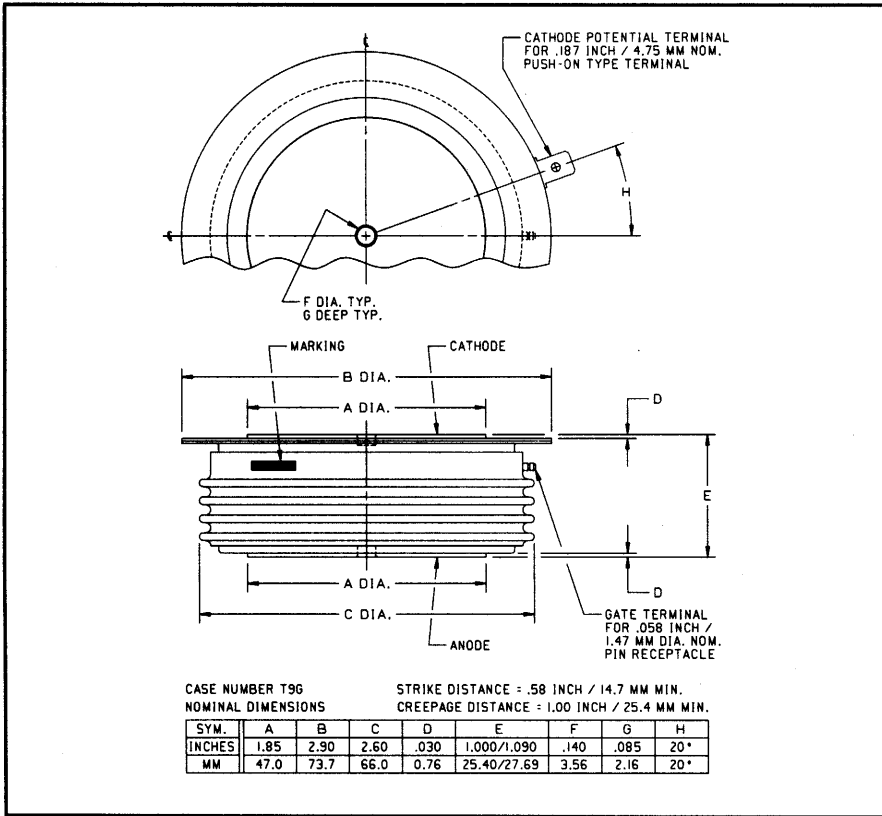

C702 (Outline Drawing)

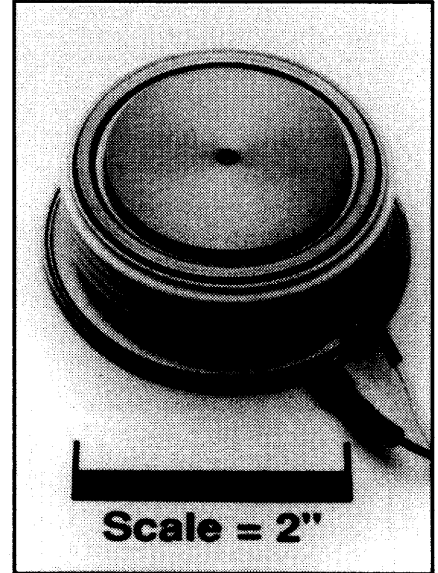

C702 Phase Control SCR
 1000 Amperes Average, 3200 Volts

Ordering Information:

Select the complete six digit part number you desire from the table, i.e. C702CB is a 3200 Volt, 1000 Ampere Phase Control SCR.

Type	Voltage		Current
	V _{DRM}	V _{RRM} Code	I _{T(av)}
C702	2400	LD	1000
	2600	LM	
	2800	LN	
	3000	CP	
	3200	CB	

Description:

Powerex Silicon Controlled Rectifiers (SCR) are designed for phase control applications. These are all-diffused, Press-Pak, hermetic Pow-R-Disc devices employing the field proven amplifying gate.

Features:

- Low On-State Voltage
- High di/dt Capability
- High dv/dt Capability
- Hermetic Packaging
- Excellent Surge and I²t Ratings

Applications:

- Power Supplies
- Motor Control



Powerex, Inc., 200 Hillis Street, Youngwood, Pennsylvania 15697-1800 (412) 925-7272
Powerex, Europe, S.A. 428 Avenue G. Durand, BP107, 72003 Le Mans, France (43) 41.14.14

C702

Phase Control SCR

1000 Amperes Average, 3200 Volts

Absolute Maximum Ratings

Characteristics	Symbol	C702	Units
Non-repetitive Transient Peak Reverse Voltage	V_{RSM}	$V_{RRM} + 100V$	Volts
RMS On-state Current, $T_C = 74^\circ C$	$I_T(rms)$	1570	Amperes
Average Current 180° Sine Wave, $T_C = 74^\circ C$	$I_T(av)$	1050	Amperes
RMS On-state Current, $T_C = 55^\circ C$	$I_T(rms)$	1880	Amperes
Average Current 180° Sine Wave, $T_C = 55^\circ C$	$I_T(av)$	1200	Amperes
Peak One Cycle Surge On-state Current (Non-repetitive) 60Hz	I_{tsm}	15000	Amperes
Peak One Cycle Surge On-state Current (Non-repetitive) 50Hz	I_{tsm}	14000	Amperes
Critical Rate-of-rise of On-state Current (Non-repetitive)	di/dt	100	A/ μ sec
Critical Rate-of-rise of On-state Current (Repetitive)	di/dt	25	A/ μ sec
I^2t (for Fusing) for One Cycle, 60Hz	I^2t	933,000	A ² sec
Peak Gate Power Dissipation	P_{GM}	200	Watts
Average Gate Power Dissipation	$P_{G(av)}$	5	Watts
Operating Temperature	T_j	-40 to +125°C	°C
Storage Temperature	T_{stg}	-40 to +125°C	°C
Approximate Weight		1	lb.
		454	g
Mounting Force		5000 to 6000	lb.
		2220 to 2660	kg.

C702

Phase Control SCR

1000 Amperes Average, 3200 Volts

Electrical Characteristics, $T_j = 25^\circ\text{C}$ Unless Otherwise Specified

Characteristics	Symbol	Test Conditions	Min.	Typ.	Max.	Units
Repetitive Peak Reverse Leakage Current	I_{RRM}	$T_j = 125^\circ\text{C}, V_R = V_{RRM}$			65	mA
		$T_j = 25^\circ\text{C}, V_R = V_{RRM}$			15	mA
Repetitive Peak Forward Leakage Current	I_{DRM}	$T_j = 125^\circ\text{C}, V_D = V_{DRM}$			65	mA
		$T_j = 25^\circ\text{C}, V_R = V_{RRM}$			15	mA
Peak On-state Voltage	V_{TM}	$T_j = 125^\circ\text{C}, I_T = 3000\text{A Peak}$ Duty Cycle < 0.1%			2.26	Volts
Threshold Voltage, Low-level	$V_{(TO)1}$	$T_j = 125^\circ\text{C}, I = 15\%, I_{T(av)}$ to $\pi I_{T(av)}$			0.94963	Volts
Slope Resistance, Low-level	r_{T1}				0.1234	m Ω
Threshold Voltage, High-level	$V_{(TO)2}$	$T_j = 125^\circ\text{C}, I = \pi I_{T(av)}$ to I_{TSM}			1.1007	Volts
Slope Resistance, High-level	r_{T2}				0.1149	m Ω
V_{TM} Coefficients, Low-level		$T_j = 125^\circ\text{C}, I = 15\% I_{T(av)}$ to $\pi I_{T(av)}$				
					$A_1 = -0.007132$	
					$B_1 = 0.18721$	
					$C_1 = 1.589\text{E-}04$	
					$D_1 = -0.011393$	
V_{TM} Coefficients, High-level		$T_j = 125^\circ\text{C}, I = \pi I_{T(av)}$ to I_{TSM}				
					$A_2 = 30.510$	
					$B_2 = -4.6029$	
					$C_2 = -2.083\text{E-}04$	
					$D_2 = 0.1610$	
Typical Delay Time	t_d	Switching from 300V, Gate = 20V, 10 Ω , 0.5 μsec Rise Time		1.8		μsec
Minimum Critical dv/dt - Exponential to V_{DRM}	dv/dt	$T_j = 125^\circ\text{C}, V_{DRM} = 0.5$ Rated, Gate Open	200			V/ μsec
Gate Trigger Current	I_{GT}	$T_C = 125^\circ\text{C},$ $V_D = 10\text{V}, R_L = 3\Omega$			200	mA
Gate Trigger Voltage	V_{GT}	$T_j = 0^\circ$ to $125^\circ\text{C},$ $V_D = 10\text{V}, R_L = 3\Omega$			4.5	Volts
Non-Trigging Gate Voltage	V_{GDM}	$T_j = 125^\circ\text{C},$ $V_D = 0.5V_{DRM}, R_L = 1000\Omega$			0.3	Volts
Peak Forward Gate Current	I_{GTM}				4	A
Peak Reverse Gate Voltage	V_{GRM}				5	Volts

Thermal Characteristics

Maximum Thermal Resistance, Double Sided Cooling

Junction-to-Case	$R_{\theta(j-c)}$	0.023	$^\circ\text{C/W}$
Case-to-Sink	$R_{\theta(c-s)}$	0.075	$^\circ\text{C/W}$

C702
Phase Control SCR
 1000 Amperes Average, 3200 Volts

Maximum On-State Forward Voltage Drop
 ($T_J = 125^\circ\text{C}$)

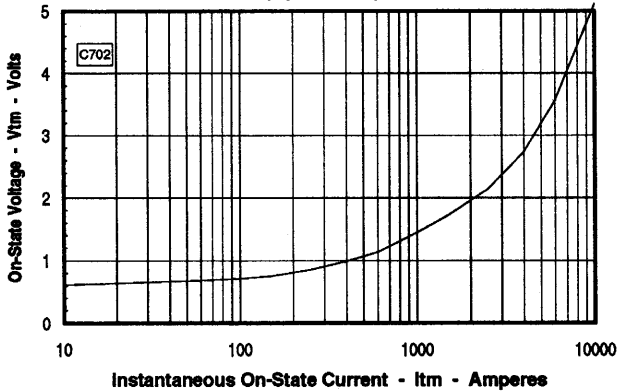

Maximum Transient Thermal Impedance
 (Junction to Case)

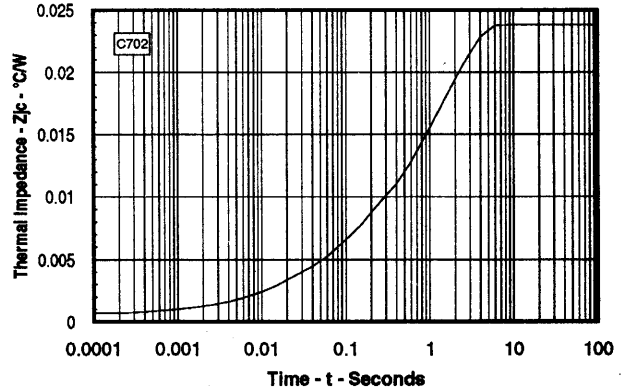

Maximum On-State Power Dissipation
 (Sinusoidal Waveform)

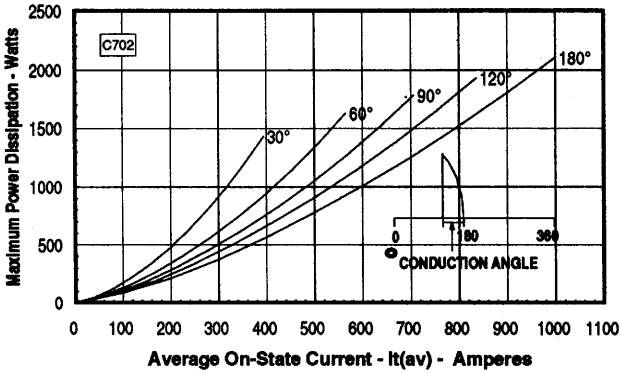

Maximum Allowable Case Temperature
 (Sinusoidal Waveform)

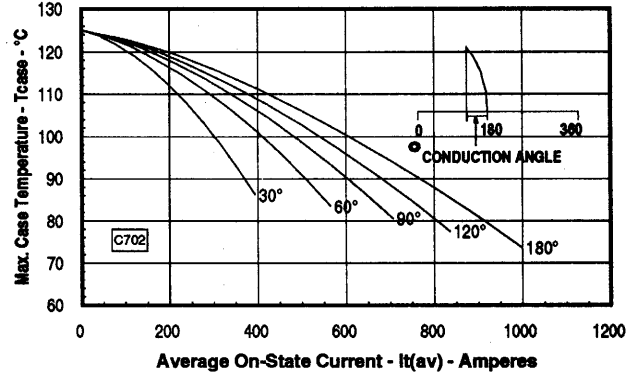

Maximum On-State Power Dissipation
 (Rectangular Waveform)

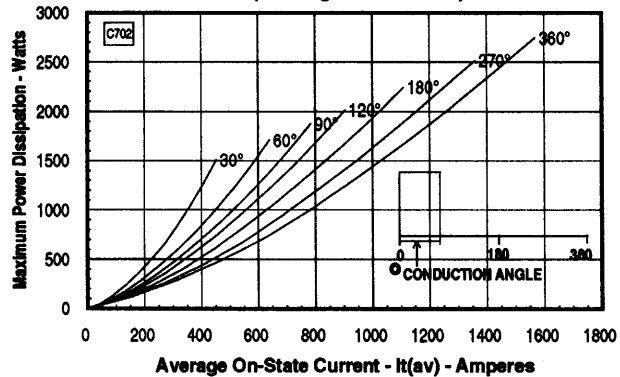

Maximum Allowable Case Temperature
 (Rectangular Waveform)

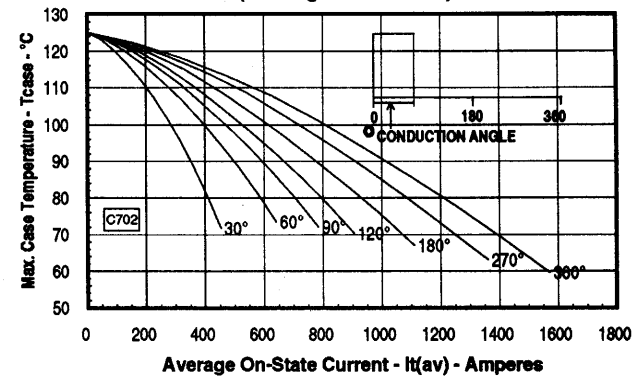



LittleDiode supplies new, hard to find or obsolete electronic components and semiconductors all over the world.

With over two million different components listed you are sure to find the part you need.

Feel free to visit us today at our online store:

LittleDiode.com

Looking forward to providing you with the best possible service.