

Powerex, Inc., 200 Hillis Street, Youngwood, Pennsylvania 15697-1800 (412) 925-7272
 Powerex, Europe, S.A. 428 Avenue G. Durand, BP107, 72003 Le Mans, France (43) 41.14.14

Phase Control SCR
 1650 Amperes Average
 4500 Volts

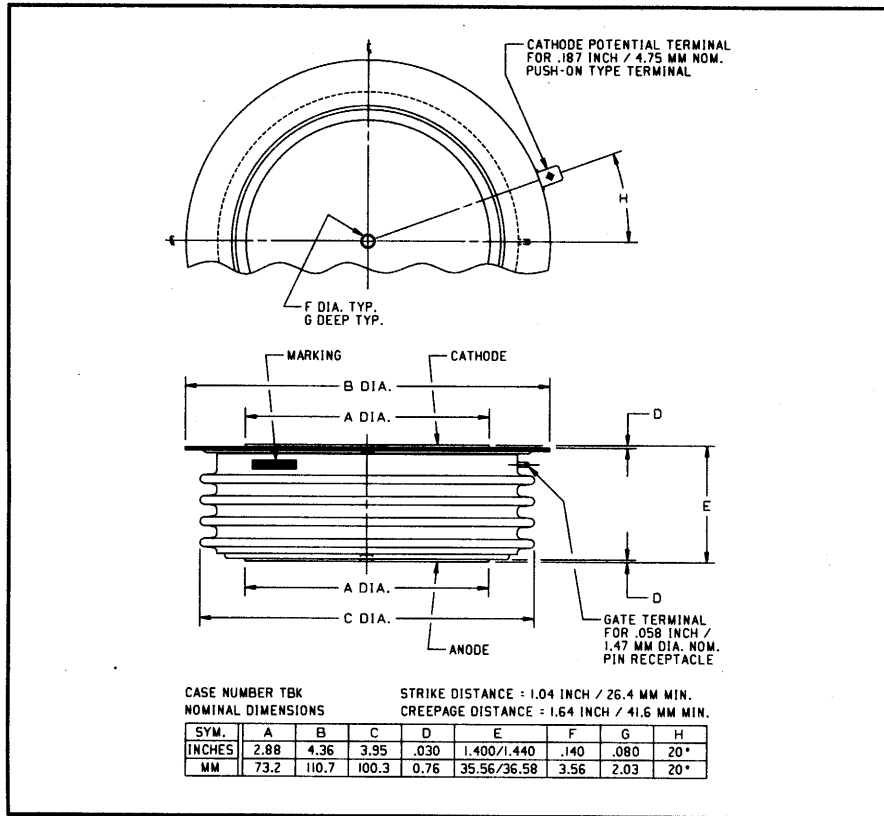

C784 (Outline Drawing)

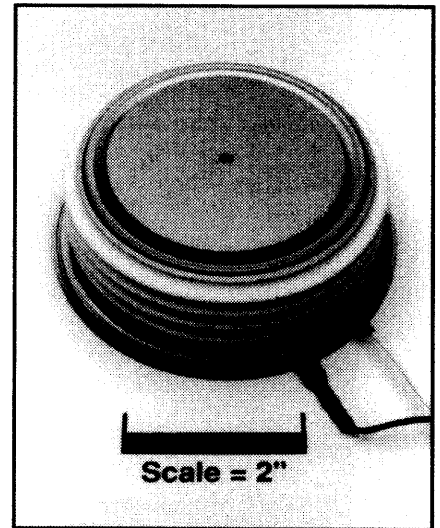

C784 Phase Control SCR
 1650 Amperes Average, 4500 Volts

Description:

Powerex Silicon Controlled Rectifiers (SCR) are designed for phase control applications. These are all-diffused, Press-Pak, hermetic Pow-R-Disc devices employing the field proven amplifying gate.

Features:

- Low On-State Voltage
- High di/dt Capability
- High dv/dt Capability
- Hermetic Packaging
- Excellent Surge and I^2t Ratings

Applications:

- Power Supplies
- Motor Control
- VAR Generators

Ordering Information:

Select the complete six digit part number you desire from the table, i.e. C784DE is a 4500 Volt, 1650 Ampere Phase Control SCR.

Type	Voltage		Current $I_{T(av)}$
	V_{DRM} V_{RRM}	Code	
C784	3600	CM	1650
	3800	CN	
	4000	DP	
	4200	DB	
	4400	DD	
	4500	DE	



Powerex, Inc., 200 Hillis Street, Youngwood, Pennsylvania 15697-1800 (412) 925-7272
Powerex, Europe, S.A. 428 Avenue G. Durand, BP107, 72003 Le Mans, France (43) 41.14.14

C784
Phase Control SCR
1650 Amperes Average, 4500 Volts

Absolute Maximum Ratings

Characteristics	Symbol	C784	Units
Non-repetitive Transient Peak Reverse Voltage	V_{RSM}	$V_{RRM} + 100V$	Volts
RMS On-state Current, $T_C = 70^\circ C$	$I_T(rms)$	2590	Amperes
Average Current 180° Sine Wave, $T_C = 70^\circ C$	$I_T(av)$	1650	Amperes
RMS On-state Current, $T_C = 55^\circ C$	$I_T(rms)$	3030	Amperes
Average Current 180° Sine Wave, $T_C = 55^\circ C$	$I_T(av)$	1930	Amperes
Peak One Cycle Surge On-state Current (Non-repetitive) 60Hz	I_{tsm}	26000	Amperes
Peak One Cycle Surge On-state Current (Non-repetitive) 50Hz	I_{tsm}	24000	Amperes
Critical Rate-of-rise of On-state Current (Non-repetitive)	di/dt	600	A/ μ sec
Critical Rate-of-rise of On-state Current (Repetitive)	di/dt	100	A/ μ sec
I^2t (for Fusing) for One Cycle, 60Hz	I^2t	2.75×10^6	A ² sec
Peak Gate Power Dissipation	P_{GM}	250	Watts
Average Gate Power Dissipation	$P_{G(av)}$	35	Watts
Operating Temperature	T_j	-40 to +125°C	°C
Storage Temperature	T_{stg}	-40 to +150°C	°C
Approximate Weight		3.5	lb.
		1.60	kg
Mounting Force		9000 to 10000	lb.
		40 to 44.5	kN

C784

Phase Control SCR

1650 Amperes Average, 4500 Volts

Electrical Characteristics, $T_j = 25^\circ\text{C}$ Unless Otherwise Specified

Characteristics	Symbol	Test Conditions	Min.	Typ.	Max.	Units
Repetitive Peak Reverse Leakage Current	I_{RRM}	$T_j = 125^\circ\text{C}, V_R = V_{RRM}$			200	mA
Repetitive Peak Forward Leakage Current	I_{DRM}	$T_j = 125^\circ\text{C}, V_D = V_{DRM}$			300	mA
Peak On-state Voltage	V_{TM}	$I_{TM} = 2000\text{A Peak}$ Duty Cycle < 0.1%			1.85	Volts
Threshold Voltage, Low-level	$V_{(TO)1}$	$T_j = 125^\circ\text{C}, I = 15\%, I_{T(av)}$ to $\pi I_{T(av)}$			1.0325	Volts
Slope Resistance, Low-level	r_{T1}				0.35754	m Ω
Threshold Voltage, High-level	$V_{(TO)2}$	$T_j = 125^\circ\text{C}, I = \pi I_{T(av)}$ to I_{TSM}			1.14596	Volts
Slope Resistance, High-level	r_{T2}				0.33617	m Ω
V_{TM} Coefficients, Low-level		$T_j = 125^\circ\text{C}, I = 15\% I_{T(av)}$ to $\pi I_{T(av)}$				
					$A_1 = 1.3364$	
					$B_1 = -0.15271$	
					$C_1 = 8.369\text{E-}05$	
					$D_1 = 0.033344$	
V_{TM} Coefficients, High-level		$T_j = 125^\circ\text{C}, I = \pi I_{T(av)}$ to I_{TSM}				
					$A_2 = 27.25$	
					$B_2 = -4.2789$	
					$C_2 = -8.503\text{E-}05$	
					$D_2 = 0.17524$	
Typical Delay Time	t_d	$T_j = 125^\circ\text{C}, V_D = 2000\text{V}$		3.0		μsec
Typical Turn-off Time	t_q	$T_j = 100^\circ\text{C}, I_T = 2000\text{A},$ $t_p > 2\text{msec}, di_T/dt = 5\text{A}/\mu\text{sec}$ $dv/dt = 1000\text{V}/\mu\text{sec}$ Linear to 2000V, $V_R = 100\text{V}$		400		μsec
Minimum Critical dv/dt - Exponential to V_{DRM}	dv/dt	$T_j = 125^\circ\text{C}$	1000			V/ μsec
Gate Trigger Current	I_{GT}	$T_j = 25^\circ\text{C}, V_D = 12\text{V}_{DC}$			300	mA
Gate Trigger Voltage	V_{GT}	$T_j = 25^\circ\text{C}, V_D = 12\text{V}_{DC}$			4.5	Volts
Non-Triggering Gate Voltage	V_{GDM}	$T_j = 125^\circ\text{C}, V_D = 2000\text{V}$			0.8	Volts
Peak Forward Gate Current	I_{GTM}				20	A
Peak Reverse Gate Voltage	V_{GRM}				20	Volts

Thermal Characteristics

Maximum Thermal Resistance, Double Sided Cooling

Junction-to-Case	$R_{\theta(j-c)}$		0.012	$^\circ\text{C/W}$
Case-to-Sink	$R_{\theta(c-s)}$		0.002	$^\circ\text{C/W}$

Powerex, Inc., 200 Hillis Street, Youngwood, Pennsylvania 15697-1800 (412) 925-7272
 Powerex, Europe, S.A. 428 Avenue G. Durand, BP107, 72003 Le Mans, France (43) 41.14.14

C784
Phase Control SCR
 1650 Amperes Average, 4500 Volts

Maximum On-State Forward Voltage Drop
 ($T_J = 125^\circ\text{C}$)

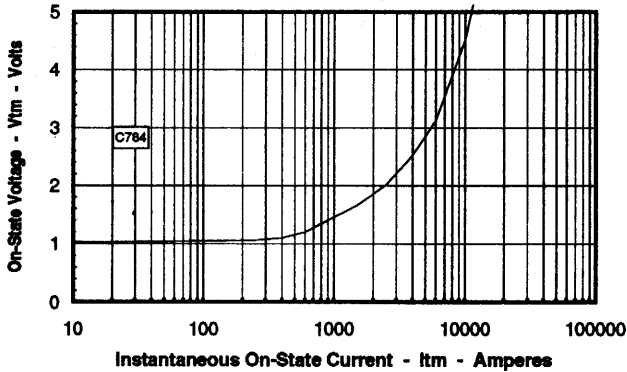

Maximum Transient Thermal Impedance
 (Junction to Case)

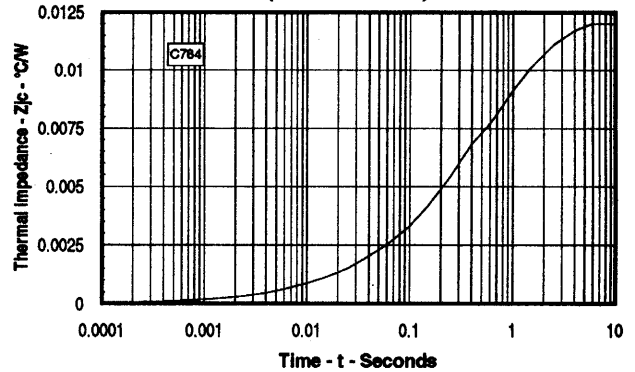

Maximum On-State Power Dissipation
 (Sinusoidal Waveform)

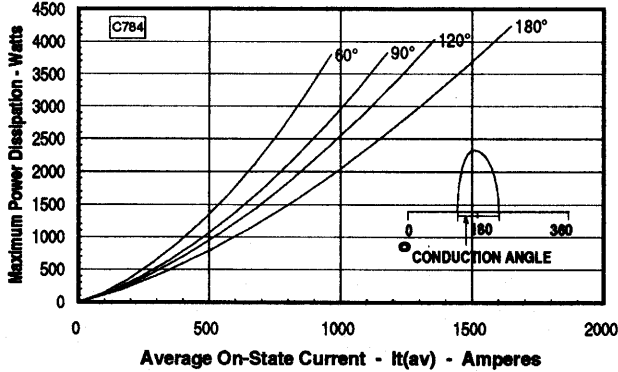

Maximum Allowable Case Temperature
 (Sinusoidal Waveform)

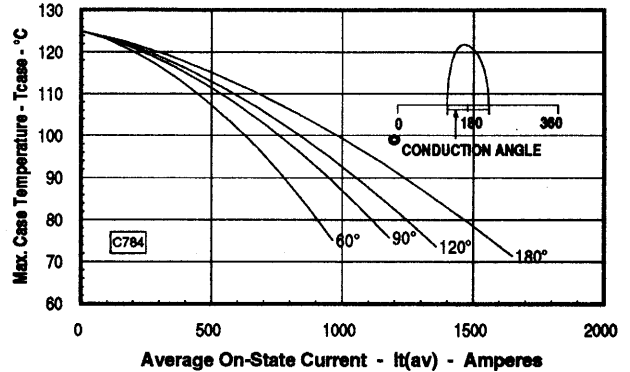

Maximum On-State Power Dissipation
 (Rectangular Waveform)

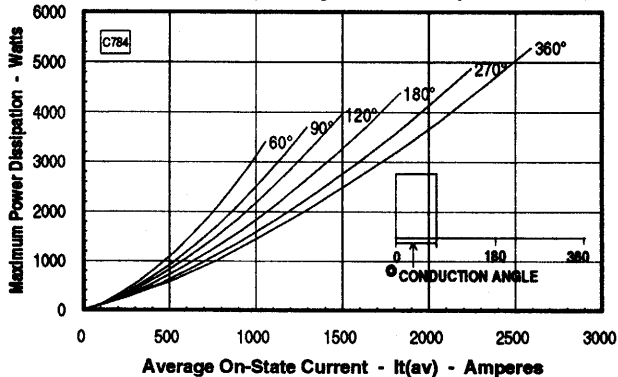

Maximum Allowable Case Temperature
 (Rectangular Waveform)

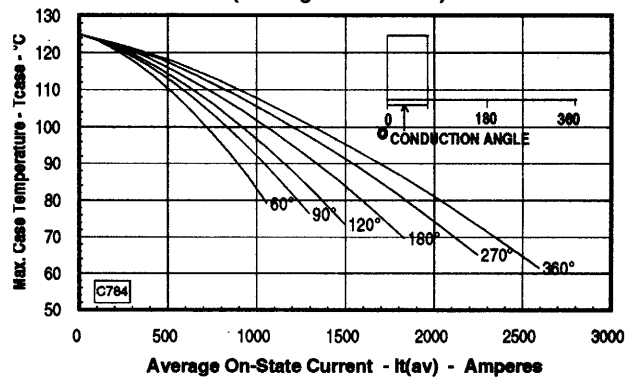

Note: Spreading losses included. Curves are for an inductive load.



LittleDiode supplies new, hard to find or obsolete electronic components and semiconductors all over the world.

With over two million different components listed you are sure to find the part you need.

Feel free to visit us today at our online store:

LittleDiode.com

Looking forward to providing you with the best possible service.