

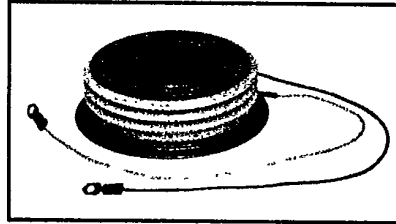

C784

Powerex, Inc. Hills Street, Youngwood, Pennsylvania 15697 (412) 925-7272
 Powerex Europe, S.A., 428 Ave. G. Durand, BP107, 72003 LeMans, France (43) 72.75.15

Phase Control SCR
1650 Amperes Avg
3600-4400 Volts

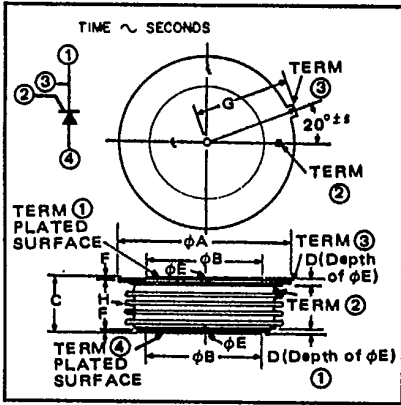

C784
Phase Control SCR
 1650 Amperes/3600-4400 Volts

C784
Outline Drawing

Dimensions	Inches		Millimeters	
	Min.	Max.	Min.	Max.
ϕA	—	4.350	—	110.49
ϕB	2.876	2.880	73.05	73.15
C	1.387	1.447	35.23	36.75
D	.080	—	2.03	—
ϕE	0.136	0.146	3.45	3.71
F	0.20	—	5.08	—
G	2.403	2.418	61.16	61.42
H	—	—	—	—

Description

Powerex Silicon Controlled Rectifiers (SCR) are designed for phase control applications. These are all-diffused, Press-Pak (Pow-R-Disc) devices employing the field-proven amplifying (di/namic) gate.

Features:

- Low On-State Voltage
- High di/dt
- High dv/dt
- Hermetic Packaging
- Excellent Surge and I²t Ratings

Applications:

- Power Supplies
- Battery Chargers
- Motor Control
- Light Dimmers
- VAR Generators

Ordering Information

Example: Select the complete six digit part number you desire from the table - i.e. C784DD is a 4400 Volt, 1650 Ampere Phase Control SCR.

Type	Voltage		Current
	V _{onm} V _{nom}	Code	
C784	3600	CM	1650
	3700	CS	
	3800	CN	
	3900	CT	
	4000	DP	
	4100	DA	
	4200	DB	
	4300	DC	
4400	DD		



Powerex, Inc., Hillis Street, Youngwood, Pennsylvania 15697 (412) 925-7272

Powerex Europe, S.A., 428 Ave. G. Durand, BP107, 72003 LeMans, France (43) 72.75.15

C784

Phase Control SCR

1650 Amperes Avg/3600-4400 Volts

Absolute Maximum Ratings

	Symbol	C784	Units
RMS On-State Current	$I_{T(RMS)}$	2590	Amperes
Average On-State Current	$I_{T(av)}$	1650	Amperes
Peak One-Cycle Surge (Non-Repetitive) On-State Current (60Hz)	I_{TSM}	26,000	Amperes
Peak One-Cycle Surge (Non-Repetitive) On-State Current (50Hz)	I_{TSM}	24,000	Amperes
Critical Rate-of-Rise of On-State Current (Non-Repetitive)	di/dt	600	Amperes/ μ s
Critical Rate-of-Rise of On-State Current (Repetitive)	di/dt	100	Amperes/ μ s
I^2t (for Fusing), One Cycle at 60Hz	I^2t	2.75×10^6	A ² sec
Peak Gate Power Dissipation, 100 microseconds	P_{GM}	250	Watts
Average Gate Power Dissipation	$P_{G(av)}$	35	Watts
Storage Temperature	T_{STG}	-40 to 150	°C
Operating Temperature	T_J	-40 to 125	°C
Mounting Force [Ⓞ]		9000 to 10,000	lb.
Mounting Force [Ⓞ]		44 to 44.5	kN

Electrical and Thermal Characteristics

Characteristics	Symbol	Test Conditions	C784	Units
Voltage—Blocking State Maximums				
Forward Leakage, Peak	I_{DRM}	$T_J = 125^\circ\text{C}, V_{DRM} = \text{Rated}$	300	mA
Reverse Leakage, Peak	I_{RRM}	$T_J = 125^\circ\text{C}, V_{RRM} = \text{Rated}$	200	mA
Current—Conducting State Maximums				
Peak On-State Voltage	V_{TM}	$T_J = 125^\circ\text{C}, I_{TM} = 2000\text{A}$	1.85	Volts
Switching				
Typical Turn-Off Time	t_q	$T_J = 100^\circ\text{C}, I_T = 2000\text{A}$ $t_b > 2\text{ms}; di/dt = 5\text{A}/\mu\text{s};$ $V_R = 100\text{V};$ $dv/dt = 1000\text{V}/\mu\text{s};$ $V \text{ reapplied} = 2000\text{V}$	400	μsec
Typical Delay Time	t_d	$T_J = 125^\circ\text{C}, V_D = 2000\text{V}$	3	μsec
Min. Critical dv/dt exponential to V_{DRM}	dv/dt	$T_J = 125^\circ\text{C}, V_D = .7V_{DRM}$	1000	V/ μsec
Thermal				
Maximum Thermal Resistance, [Ⓞ] double sided cooling Junction to Case	$R_{\theta JC}$.012	°C/Watt
Case to Sink, Lubricated	$R_{\theta CS}$.002	°C/Watt
Gate—Maximum Parameters				
Gate Current to Trigger	I_{GT}	$T_J = 25^\circ\text{C}, V_D = 12\text{Vdc}$	300	mA
Gate Voltage to Trigger	V_{GT}	$T_J = 25^\circ\text{C}, V_D = 12\text{Vdc}$	4.5	Volts
Non-Trigging Gate Voltage	V_{GDM}	$T_J = 125^\circ\text{C}, V_D = 2000\text{V}$.8	Volts
Peak Forward Gate Current	I_{GTM}		20	Amperes
Peak Reverse Gate Voltage	V_{GRM}		20	Volts

[Ⓞ] Consult recommended mounting procedures.



Powerex, Inc., Hillis Street, Youngwood, Pennsylvania 15697 (412) 925-7272
 Powerex Europe, S.A., 428 Ave. G. Durand, BP107, 72003 LeMans, France (43) 72.75.15

C784
 Phase Control SCR
 1650 Amperes Avg/3600-4400 Volts

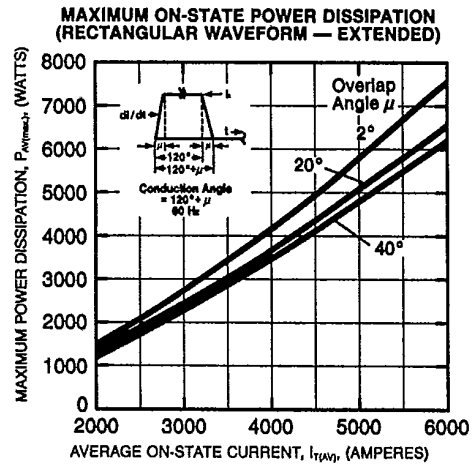
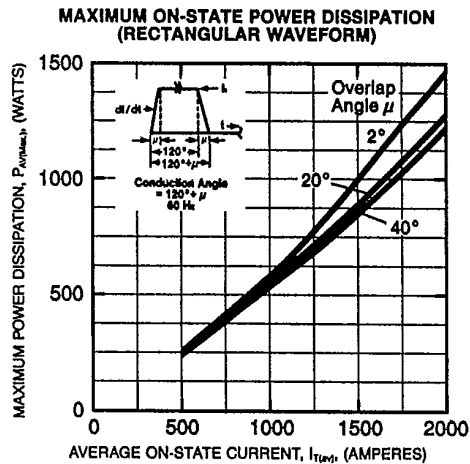
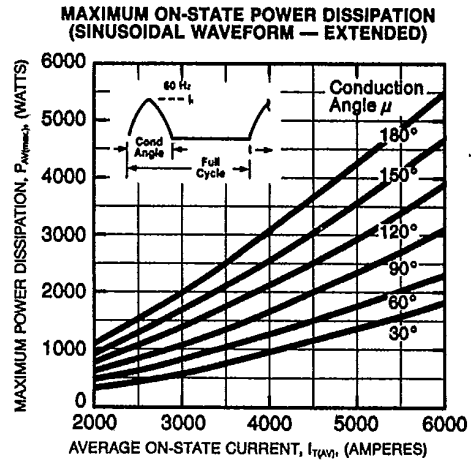
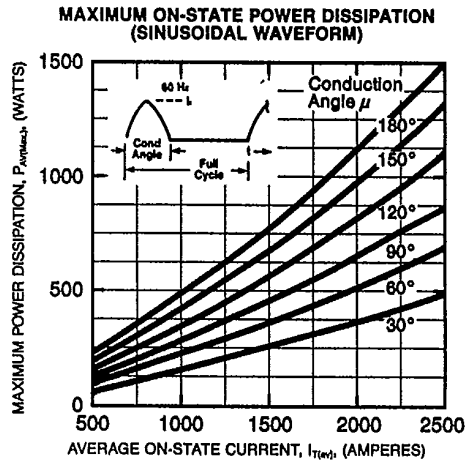
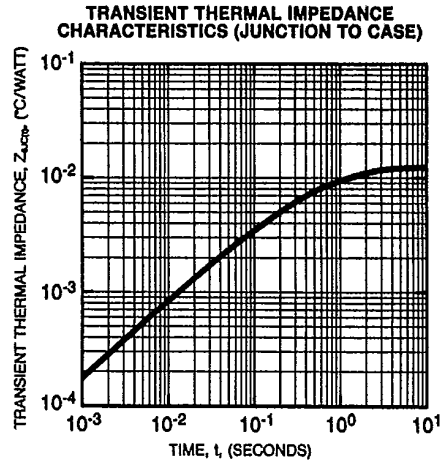
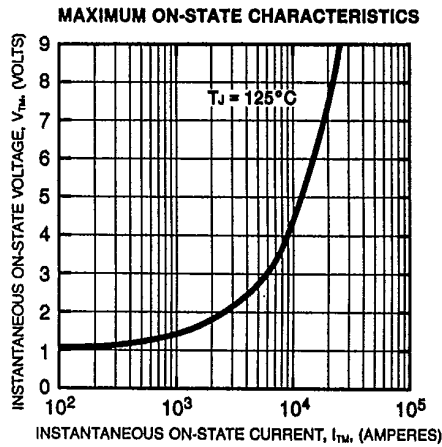



Powerex, Inc., Hillis Street, Youngwood, Pennsylvania 15697 (412) 925-7272
 Powerex Europe, S.A., 428 Ave. G. Durand, BP107, 72003 LeMans, France (43) 72.75.15

C784
 Phase Control SCR
 1650 Amperes Avg/3600-4400 Volts

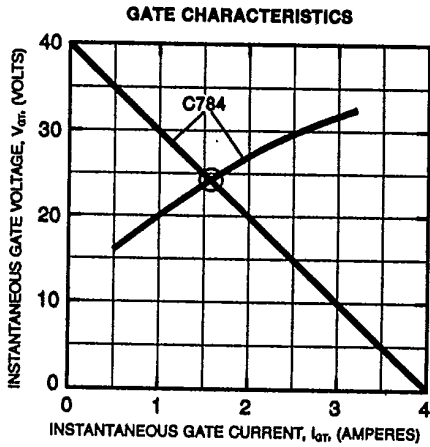
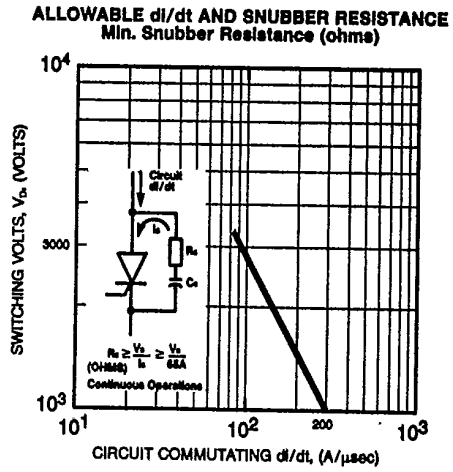
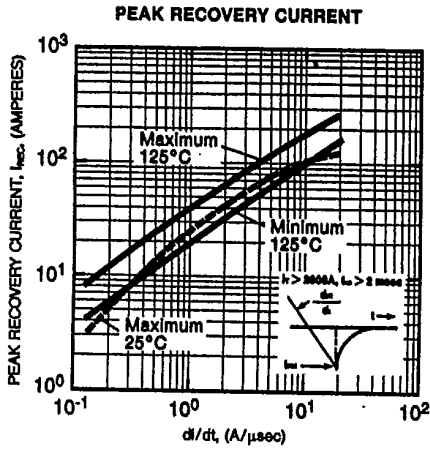



LittleDiode supplies new, hard to find or obsolete electronic components and semiconductors all over the world.

With over two million different components listed you are sure to find the part you need.

Feel free to visit us today at our online store:

LittleDiode.com

Looking forward to providing you with the best possible service.