

BGA428

BGA428 High Gain, Low Noise
Amplifier

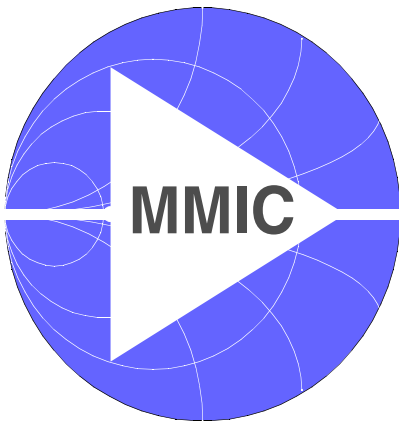

Wireless
Silicon Discretes



Never stop thinking.

Edition 2002-03-26

**Published by Infineon Technologies AG,
St.-Martin-Strasse 53,
D-81541 München**

**© Infineon Technologies AG 2002
All Rights Reserved.**

Attention please!

The information herein is given to describe certain components and shall not be considered as warranted characteristics.

Terms of delivery and rights to technical change reserved.

We hereby disclaim any and all warranties, including but not limited to warranties of non-infringement, regarding circuits, descriptions and charts stated herein.

Infineon Technologies is an approved CECC manufacturer.

Information

For further information on technology, delivery terms and conditions and prices please contact your nearest Infineon Technologies Office in Germany or our Infineon Technologies Representatives worldwide (see address list).

Warnings

Due to technical requirements components may contain dangerous substances. For information on the types in question please contact your nearest Infineon Technologies Office.

Infineon Technologies Components may only be used in life-support devices or systems with the express written approval of Infineon Technologies, if a failure of such components can reasonably be expected to cause the failure of that life-support device or system, or to affect the safety or effectiveness of that device or system. Life support devices or systems are intended to be implanted in the human body, or to support and/or maintain and sustain and/or protect human life. If they fail, it is reasonable to assume that the health of the user or other persons may be endangered.

BGA428**Data sheet****Revision History: 2002-03-26**Previous Version: 2000-11-15

Page	Subjects (major changes since last revision)
4	dot size for pin 1 package marking increased

For questions on technology, delivery and prices please contact the Infineon Technologies Offices in Germany or the Infineon Technologies Companies and Representatives worldwide: see our webpage at <http://www.infineon.com>

Features

- High gain, $G_{MA}=20\text{dB}$ at 1.8GHz
- Low noise figure, $NF=1.4\text{dB}$ at 1.8GHz
- Prematched
- Ideal for GSM, DCS1800, PCS1900
- Open collector output
- Typical supply voltage: 2.4-3V
- SIEGET[®]-45 technology

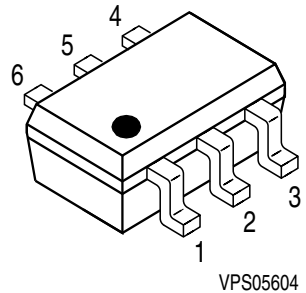

Tape loading orientation

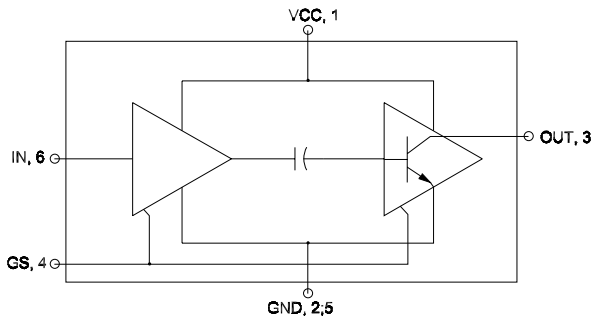
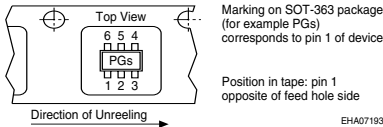

ESD: Electrostatic discharge sensitive device, observe handling precaution!

Type	Package	Marking	Chip
BGA428	SOT363	PGs	T0527

Maximum Ratings

Parameter	Symbol	Value	Unit
Device voltage	V_{CC}	4	V
Total Device Current ³⁾	I_{tot}	12	mA
Voltage at pin <i>Out</i>	V_{Out}	4	V
Current into pin <i>In</i>	I_{IN}	0.5	mA
Voltage at pin <i>GS</i>	V_{GS}	3.5	V
Total power dissipation, $T_s < 125^{\circ}C$ ¹⁾	P_{tot}	50	mW
Junction temperature	T_j	150	$^{\circ}C$
Operating temperature range	T_{OP}	-40 ..+85	$^{\circ}C$
Storage temperature range	T_{STG}	-65 ... +150	$^{\circ}C$
Thermal resistance: junction-soldering point	$R_{th JS}$	220	K/W
Input power ²⁾	P_{IN}	8	dBm

Notes:

All Voltages refer to GND-Node

¹⁾ T_s is measured on the ground lead at the soldering point

²⁾ Valid for a) $Z_L=50\Omega$ and $Z_S=50\Omega$, $V_{CC}=2.7V$, $V_{OUT}=2.7V$, $V_{GS}=0.0V$, $GND=0.0V$
and b) $Z_L=50\Omega$ and $Z_S=50\Omega$, $V_{CC}=0.0V$, $V_{OUT}=0.0V$, $V_{GS}=2.7V$, $GND=0.0V$

³⁾ I_{tot} = Current into OUT + Current into VCC

Electrical Characteristics at $T_A=25^{\circ}C$ (measured in test circuit specified in fig. 1)

$V_{CC}=2.7V$, Frequency=1.8GHz, unless otherwise specified

Parameter	Symbol	min.	typ.	max.	Unit
Maximum available power gain	G_{MA}		20		dB
Noise figure ($Z_S=50\Omega$)	NF		1.4		dB
Input power at 1dB gain compression	P_{-1dB}		-19		dBm
Input third order intercept point	IIP_3		-9		dBm
Total device current	I_{tot}		8.2		mA
Insertion loss in gain-step-mode $V_{CC}=0.0V$, $V_{CTRL}=2.7V$, $R_{CTRL}=3k\Omega$	L_{GS}		13.5		dB

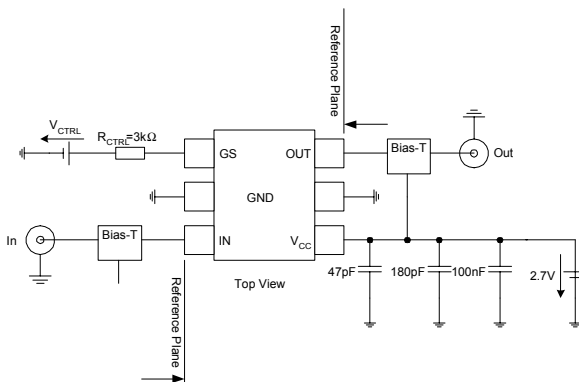

Fig. 1: Test Circuit for Electrical Characteristics and S-Parameter

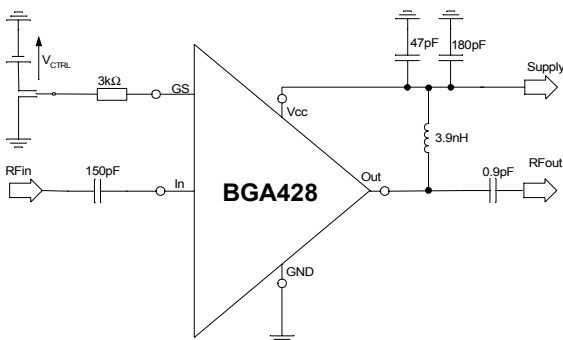

Fig. 2: Application Circuit for 1850MHz

S-Parameter at 2.7V (see Electrical Characteristics for conditions)

Freq. [GHz]	S11 Mag	S11 Ang	S21 Mag	S21 Ang	S12 Mag	S12 Ang	S22 Mag	S22 Ang
0.100	0.6756	-31.7	58.775	-19.6	0.0005	153.5	0.9491	-3.9
0.200	0.5936	-53.6	47.806	-43.1	0.0014	138.4	0.9327	-6.3
0.300	0.5150	-71.4	39.232	-59.5	0.0021	119.0	0.9174	-8.3
0.400	0.4587	-86.6	32.740	-71.8	0.0028	104.9	0.9035	-10.3
0.600	0.4004	-110.7	23.868	-89.6	0.0042	105.9	0.8807	-14.0
0.800	0.3743	-129.1	18.509	-103.2	0.0063	94.3	0.8593	-17.7
1.000	0.3743	-143.0	14.825	-114.5	0.0082	92.4	0.8352	-21.4
1.200	0.3816	-154.5	12.288	-124.7	0.0093	87.2	0.8116	-25.1
1.400	0.3922	-164.4	10.353	-134.2	0.0110	85.3	0.7865	-28.7
1.600	0.4086	-172.4	8.879	-143.2	0.0132	79.4	0.7597	-32.2
1.800	0.4265	-178.9	7.732	-151.4	0.0141	79.4	0.7309	-36.0
1.900	0.4314	178.8	7.214	-155.2	0.0146	76.1	0.7199	-37.5
2.000	0.4371	176.1	6.771	-159.1	0.0150	77.0	0.7097	-39.1
2.200	0.4505	171.2	5.976	-166.6	0.0169	75.2	0.6791	-42.3
2.400	0.4640	167.2	5.298	-173.5	0.0181	73.2	0.6593	-45.6
3.000	0.4935	155.9	3.935	167.0	0.0217	68.3	0.5925	-53.3
4.000	0.5181	141.2	2.605	139.2	0.0282	65.1	0.5284	-64.9
5.000	0.5202	126.9	1.911	113.6	0.0319	62.2	0.4829	-75.1
6.000	0.5128	110.0	1.479	89.9	0.0489	56.0	0.4323	-81.7

Application Circuit Characteristics (measured in test circuit specified in fig. 2)

 TA=25°C, V_{CC}=2.7V, Frequency=1.85GHz, unless otherwise specified

Parameter	Symbol	typ.	Unit
Insertion power gain	$ S_{21} ^2$	19	dB
Noise Figure ($Z_S=50\Omega$)	NF	1.4	dB
Input Power at 1dB Gain Compression	P_{-1dB}	-19	dBm
Input Third Order Intercept Point	IIP ₃	-9	dBm
Total Device Current	I_{tot}	8.2	mA
Insertion Loss in Gain-Step-Mode V _{CC} =0.0V, V _{CTRL} =2.7V, R _{CTRL} =3kΩ	L_{GS}	13.5	dB

The following data refers to the application circuit given in fig. 2

Power Gain $|S_{21}|^2=f(f)$

$V_{CC} = 2.7V, V_{Out}=2.7V$

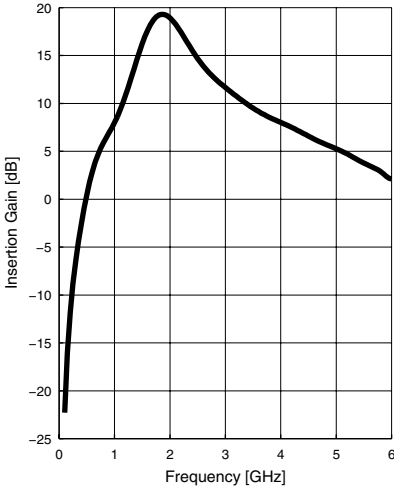

Power Gain $|S_{21}|^2=f(f)$

$V_{CC} = 2.7V, V_{Out}=2.7V$

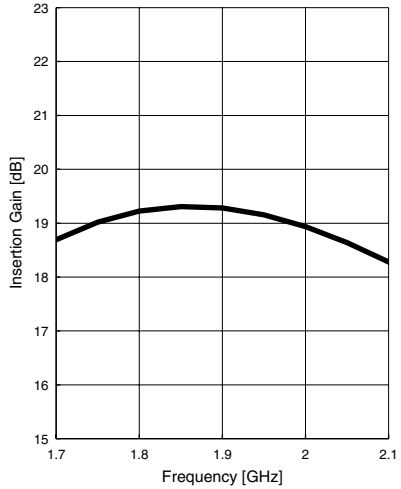

Off-Gain $|S_{21}|^2=f(V_{CTRL})$

$V_{CC} = 0.0V, V_{Out}=0.0V, R_{CTRL}=2.7k\Omega$

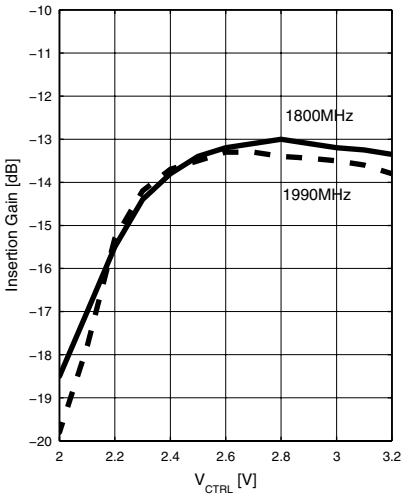

Matching $|S_{11}|, |S_{22}|=f(f)$

$V_{CC} = 2.7V, V_{Out}=2.7V$

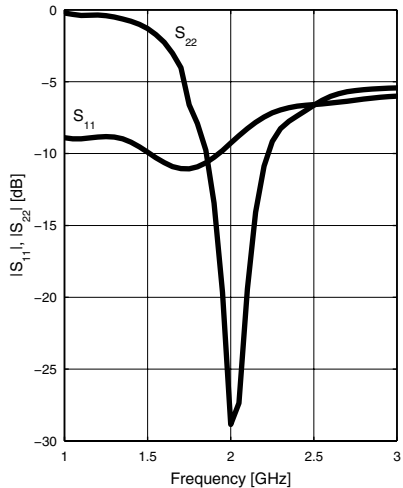

Input Compression Point $P_{-1dB}=f(f)$

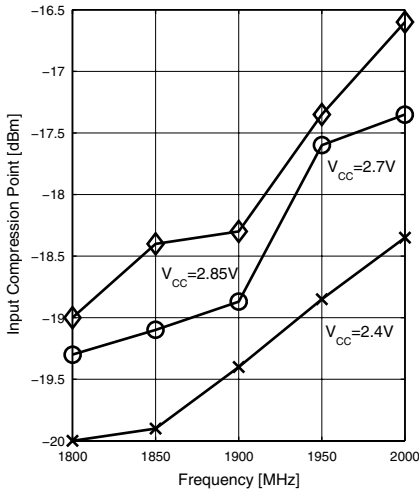

Device Current $I=f(\vartheta)$

$V_{CC}=2.7V, V_{Out}=2.7V$

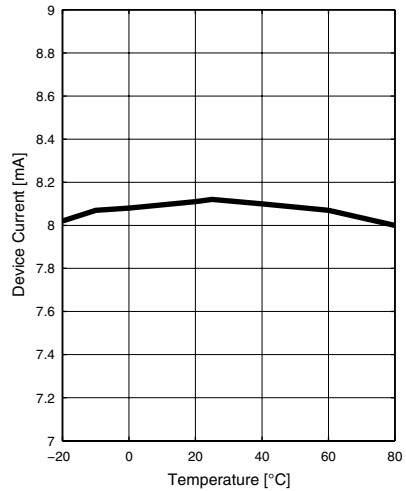

Insertion Gain $|S_{21}|^2=f(\vartheta)$

$V_{CC}=2.7V, V_{Out}=2.7V$

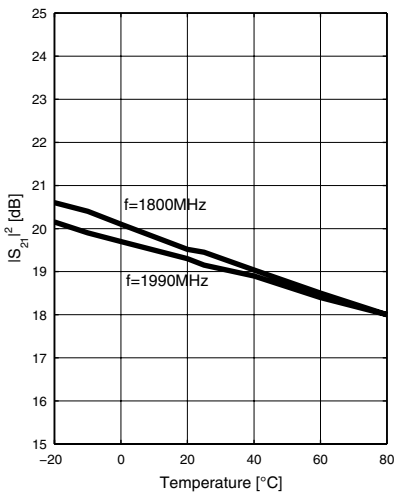

Package Outline

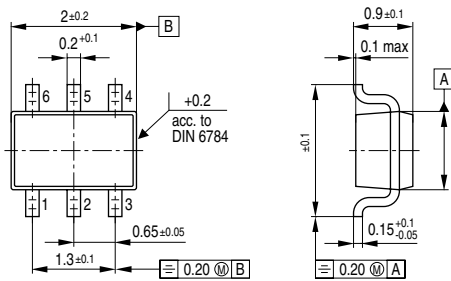

GPS05604



LittleDiode supplies new, hard to find or obsolete electronic components and semiconductors all over the world.

With over two million different components listed you are sure to find the part you need.

Feel free to visit us today at our online store:

LittleDiode.com

Looking forward to providing you with the best possible service.