

Headphone amplifier for CD-ROMs

BH3541F / BH3544F

The BH3541F and BH3544F are digital-source dual headphone amplifiers. The BH3541F has a fixed gain of 0dB and the BH3544F has a fixed gain of 6dB so that external gain setting is unnecessary. Both the BH3541F and BH3544F have internal mute functions so that prevention of the popping sound when power is turned on and off is greatly simplified. Also, these ICs are equipped with thermal shutdown circuits to prevent damage from short circuits.

Product name	Fixed gain
BH3541F	0dB
BH3544F	6dB

●Applications

Devices that use the headphone output from CD-ROMs, CDs, MDs, personal computers, notebook computers, camcorders, etc.

●Features

- 1) Internal mute function to prevent popping sounds when the power is turned on and off.
- 2) Built-in thermal shutdown circuit (150°C) to prevent damage to the IC if a short circuit occurs.
- 3) Compact SOP8 pin package.

●Absolute maximum ratings (Ta = 25°C)

Parameter	Symbol	Limits	Unit
Applied voltage	V _{Max}	7.0	V
Power dissipation	P _d	450 *	mW
Operating temperature	T _{opr}	-25 ~ +75	°C
Storage temperature	T _{stg}	-55 ~ +125	°C

*Reduced by 4.5mW for each increase in Ta of 1°C over 25°C.

●Recommended operating conditions (Ta = 25°C)

Parameter	Symbol	Min.	Typ.	Max.	Unit
Power supply voltage	V _{cc}	2.8	-	6.5	V

Optical disc ICs

●Block diagram

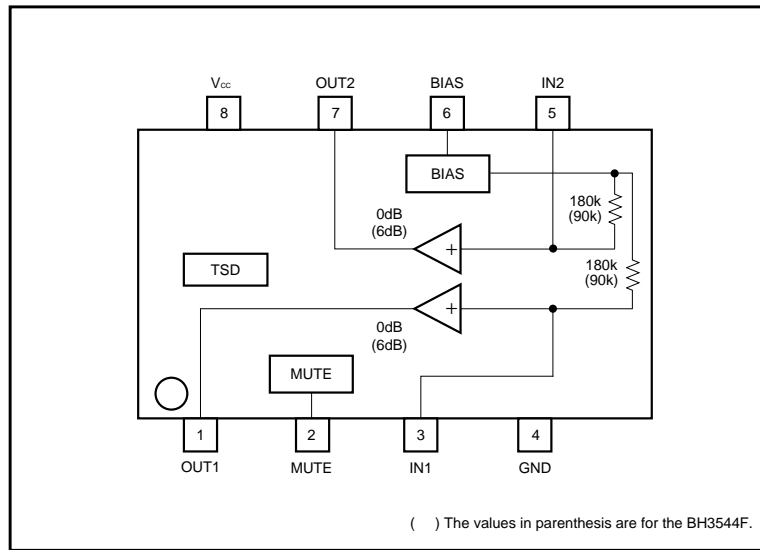

Optical disc ICs

●Pin descriptions

Pin No.	Pin name	I / O	Pin voltage	Internal equivalent circuit	Function
1	OUT1	O	2.1V		Output pin
7	OUT2	O	2.1V (Vcc=5V)		
2	MUTE	I	0.1V (When open)		Mute control pin (set to low for prevention of popping noise when power is turned on and off). Operating : High Muting : Low (open)
3	IN1	I	2.1V		Input pin
5	IN2	I	2.1V (Vcc=5V)		
6	BIAS	I / O	2.1V (Vcc=5V)		Bias pin (the external 47μF capacitor also serves as the anti-pop time constant, therefore make the proper considerations be changing it).
4	GND	I	-	_____	_____
8	Vcc	I	-	_____	_____

Optical disc ICs

● Measurement conditions

Signal	SW table						Monitor	Conditions
	SW1	SW3	SW5	SW7	SW8A	SW8B		
I _Q	1	1	1	1	2	OFF	IQ	–
V _{TM}	–	–	–	–	–	–	–	–
G _{Vc}	1	2	2	1	2	ON	V1AC, V2AC	f _{in} =1kHz, V _{IN1/2} =0dBV (V _{IN1/2} =–6dBV), V _{TM} =1.6V
ΔG _{Vc}	–	–	–	–	–	–	–	GVC1–GVC2
THD	1	2	2	1	2	ON	V1AC, V2AC	f _{in} =1kHz, V _{IN1/2} =0dBV (V _{IN1/2} =–6dBV), V _{TM} =1.6V
P _{O1}	1	2	2	1	2	ON	V1AC, V2AC	f _{in} =1kHz, V _{IN1/2} =0dBV (V _{IN1/2} =–6dBV), V _{TM} =1.6V
P _{O2}	2	2	2	2	2	ON	V1AC, V2AC	f _{in} =1kHz, V _{IN1/2} =0dBV (V _{IN1/2} =–6dBV), V _{TM} =1.6V
V _{No}	1	1	1	1	2	ON	V1AC, V2AC	–
CS	1	1	2	1	2	ON	V1AC, V2AC	f _{in} =1kHz, V _{IN2} =0dBV (V _{IN2} =–6dBV), V _{TM} =1.6V
	1	2	1	1	2	ON	V1AC, V2AC	f _{in} =1kHz, V _{IN1} =0dBV (V _{IN1} =–6dBV), V _{TM} =1.6V
ATT	1	2	2	1	2	ON	V1AC, V2AC	f _{in} =1kHz, V _{IN1/2} =0dBV (V _{IN1/2} =–6dBV), V _{TM} =0.3VB
RR	1	1	1	1	1	ON	V1AC, V2AC	V _{RR} =–20dBV, f _{RR} =100Hz

*() The values in parenthesis are for the BH3544F.

● Circuit operation

Rising edge timing

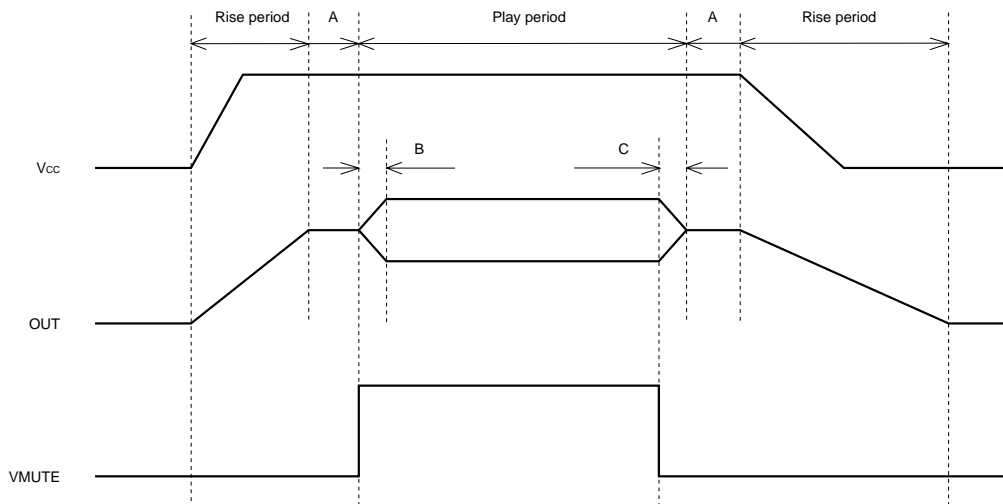

A : MUTE period (use with MUTE = Low to prevent the popping noise when the power is turned on and off).

B : MUTE release time (used to prevent the popping noise at the release of MUTE with the external C2 and R2, and therefore possesses a time constant, so be careful of the timing).

C : MUTE start time (also possesses a time constant like the MUTE release time).

Optical disc ICs

●Operation notes

The application example is recommended by ROHM, but before use in your application, be sure to carefully confirm electrical characteristics.

Also, for use with different circuit constants for the external circuits, be sure to leave a sufficient margin for fluctuations in characteristics in the external components and ROHM ICs in not only the static characteristics, but also the transient characteristics as well.

●Electrical characteristic curves

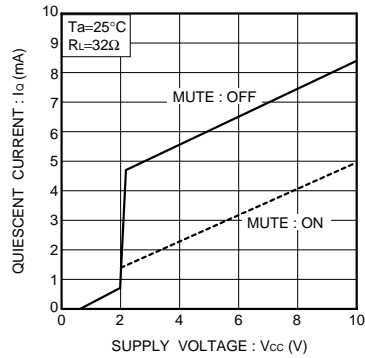

Fig.3 Quiescent current vs. power supply voltage

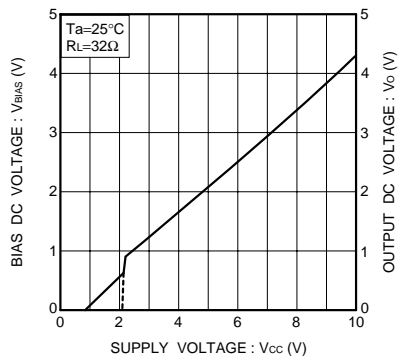

Fig.4 Pin DC current vs. power supply voltage

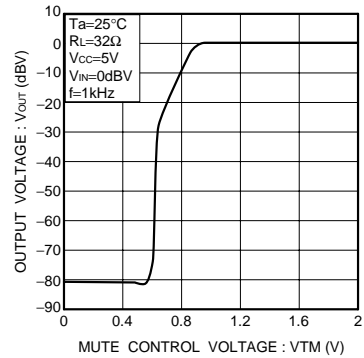

Fig.5 Output voltage vs. MUTE control voltage

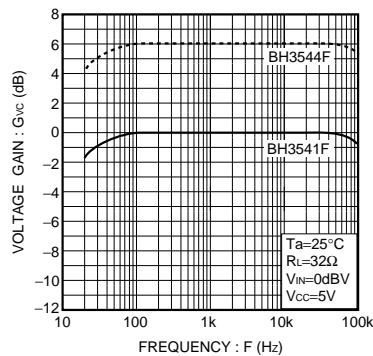

Fig.6 Voltage gain vs. frequency

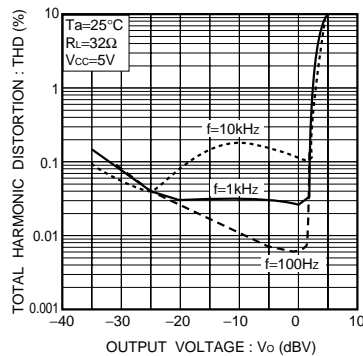

Fig.7 Total harmonic distortion vs. output voltage (I)

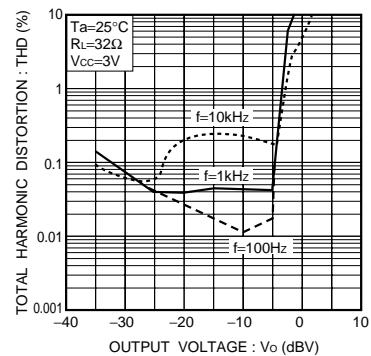

Fig.8 Total harmonic distortion vs. output voltage (II)

Optical disc ICs

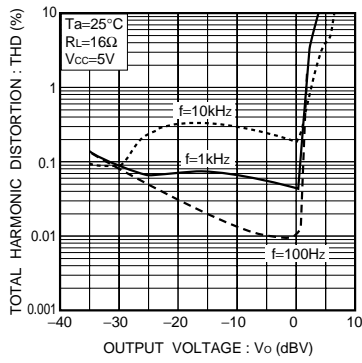

Fig.9 Total harmonic distortion vs. output voltage (III)

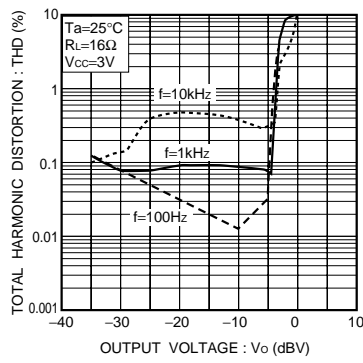

Fig.10 Total harmonic distortion vs. output voltage (IV)

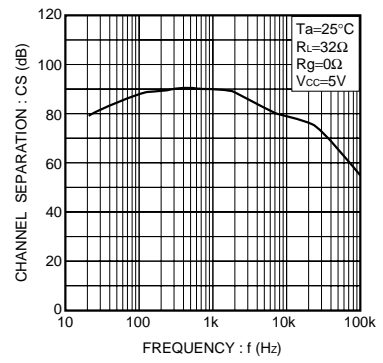

Fig.11 Channel separation vs. frequency

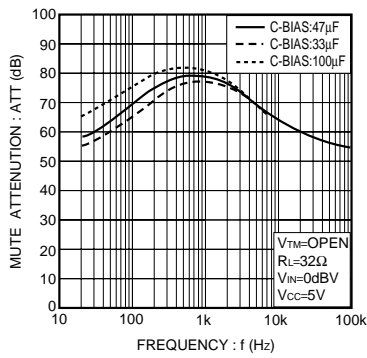

Fig.12 MUTE attenuation vs. frequency

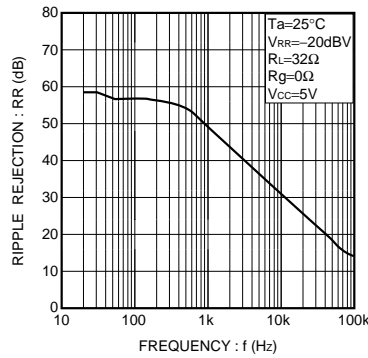

Fig.13 Ripple rejection vs. frequency

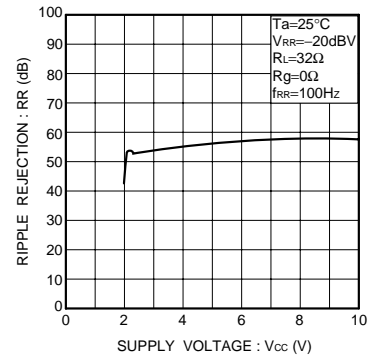
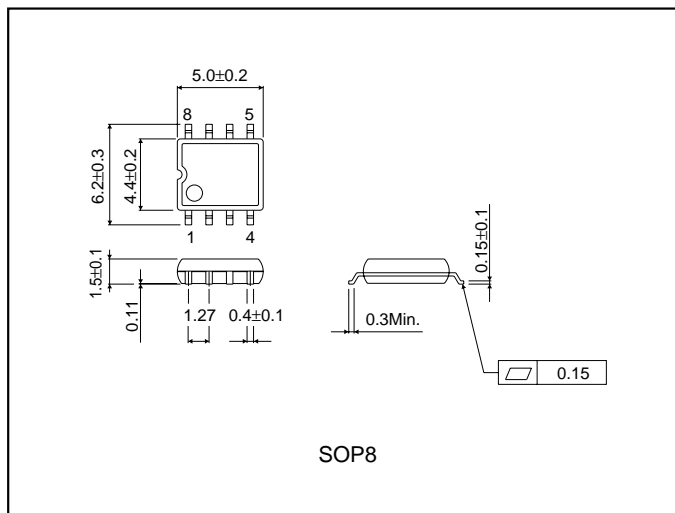

Fig.14 Ripple rejection vs. power supply voltage

●External dimensions (Units : mm)





LittleDiode supplies new, hard to find or obsolete electronic components and semiconductors all over the world.

With over two million different components listed you are sure to find the part you need.

Feel free to visit us today at our online store:

LittleDiode.com

Looking forward to providing you with the best possible service.