

Split Dual SCR POW-R-BLOK™ Modules 20 Amperes/800 Volts

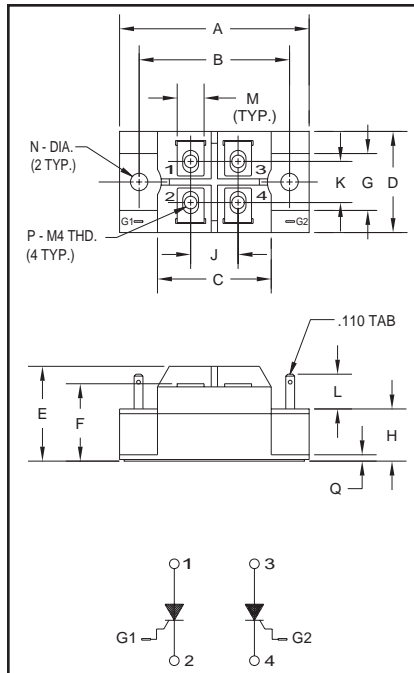

Outline Drawing

Dimension	Inches	Millimeters
A	2.362 Max.	60 Max.
B	1.874	47.6
C	1.417	36
D	1.260 Max.	32 Max.
E	1.181 Max.	30 Max.
F	0.964	24.5
G	0.703	18
H	0.650	16.5
J	0.591	15
K	0.512	13
L	0.433	11
M	0.335	8.5
N	0.216 Dia.	Dia. 5.5
P	M4 Metric	M4
Q	0.079	2



CT230802
Split Dual SCR
POW-R-BLOK™ Modules
20 Amperes/800 Volts

Description:

Powerex Split Dual SCR POW-R-BLOK™ Modules are designed for use in applications requiring control and rectification. The modules are isolated for easy mounting with other components on common heatsinks.

Features:

- Isolated Mounting
- Glass Passivated Chips
- Metal Baseplate
- Low Thermal Impedance
- Four Terminal Flexibility

Applications:

- Battery Supplies
- Contactless Switches
- Furnace Control
- Light Dimmers

Ordering Information:

Select the complete eight digit module part number you desire from the table below.

Example: CT230802 is a 800 Volt, 20 Ampere Split Dual SCR POW-R-BLOK™ Module.

Type	Voltage Volts (x100)	Current Rating Amperes (x10)
CT23	08	02



Powerex, Inc., 200 Hillis Street, Youngwood, Pennsylvania 15697-1800 (724) 925-7272

CT230802

Split Dual SCR POW-R-BLOK™ Modules

20 Amperes/800 Volts

Absolute Maximum Ratings

Characteristics	Symbol	CT230802	Units
Peak Forward Blocking Voltage	V_{DRM}	800	Volts
Transient Peak Forward Blocking Voltage (Non-Repetitive), $t < 5ms$	V_{DSM}	960	Volts
DC Forward Blocking Voltage	$V_{D(DC)}$	640	Volts
Peak Reverse Blocking Voltage	V_{RRM}	800	Volts
Transient Peak Reverse Blocking Voltage (Non-Repetitive), $t < 5ms$	V_{RSM}	960	Volts
DC Reverse Blocking Voltage	$V_{R(DC)}$	640	Volts
RMS On-State Current	$I_T(RSM)$	30	Amperes
Average On-State Current, $T_C = 87^\circ C$	$I_T(AV)$	20	Amperes
Peak One-Cycle Surge (Non-Repetitive) On-State Current (60Hz)	I_{TSM}	400	Amperes
Peak One-Cycle Surge (Non-Repetitive) On-State Current (50Hz)	I_{TSM}	365	Amperes
I^2t (for Fusing), 8.3 milliseconds	I^2t	670	A^2sec
Critical Rate-of-Rise of On-State Current*	di/dt	100	Amperes/ μs
Peak Gate Power Dissipation	P_{GM}	5.0	Watts
Average Gate Power Dissipation	$P_{G(AV)}$	0.5	Watts
Peak Forward Gate Voltage	V_{GFM}	10	Volts
Peak Reverse Gate Voltage	V_{GRM}	5.0	Volts
Peak Forward Gate Current	I_{GFM}	2.0	Amperes
Storage Temperature	T_{STG}	-40 to 125	$^\circ C$
Operating Temperature	T_j	-40 to 125	$^\circ C$
Maximum Mounting Torque M5 Mounting Screw	—	17	in.-lb.
Maximum Mounting Torque M4 Terminal Screw	—	12	lb.-in.
Module Weight (Typical)	—	80	Grams
V Isolation	V_{RMS}	2000	Volts

* $T_j = 125^\circ C$, $I_G = 0.5A$, $V_D = 1/2 V_{DRM}$

Electrical and Thermal Characteristics, $T_j = 25^\circ C$ unless otherwise specified

Characteristics	Symbol	Test Conditions	CT230802	Units
Blocking State Maximums				
Forward Leakage Current, Peak	I_{DRM}	$T_j = 125^\circ C$, $V_{DRM} = \text{Rated}$	4.0	mA
Reverse Leakage Current, Peak	I_{RRM}	$T_j = 125^\circ C$, $V_{RRM} = \text{Rated}$	4.0	mA
Conducting State Maximums				
Peak On-State Voltage	V_{TM}	$I_{TM} = 60A$	1.8	Volts
Switching Minimums				
Critical Rate-of-Rise of Off-State Voltage	dv/dt	$T_j = 125^\circ C$, $V_D = 2/3 V_{DRM}$	500	Volts/ μs
Thermal Maximums				
Thermal Resistance, Junction-to-Case	$R_{\theta(J-C)}$	Per Module	1.0	$^\circ C/Watt$
Thermal Resistance, Case-to-Sink (Lubricated)	$R_{\theta(C-S)}$	Per Module	0.25	$^\circ C/Watt$
Gate Parameters Maximums				
Gate Current-to-Trigger	I_{GT}	$V_D = 6V$, $R_L = 2\Omega$	50	mA
Gate Voltage-to-Trigger	V_{GT}	$V_D = 6V$, $R_L = 2\Omega$	3.0	Volts
Non-Triggering Gate Voltage	V_{GDM}	$T_j = 125^\circ C$, $V_D = 1/2 V_{DRM}$	0.25	Volts

CT230802
Split Dual SCR POW-R-BLOK™ Modules
 20 Amperes/800 Volts

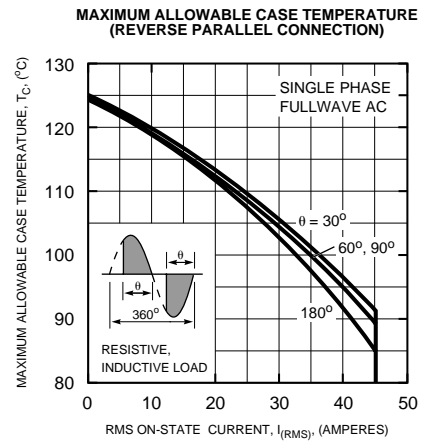
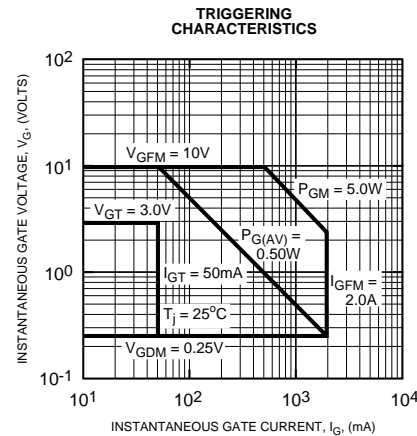
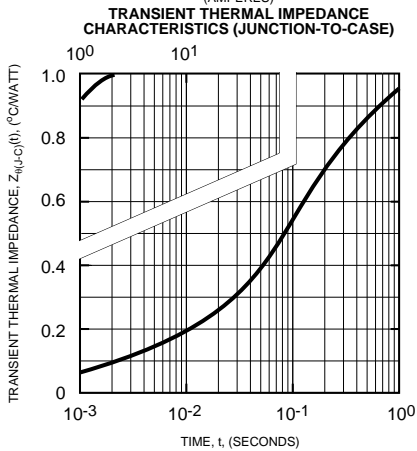
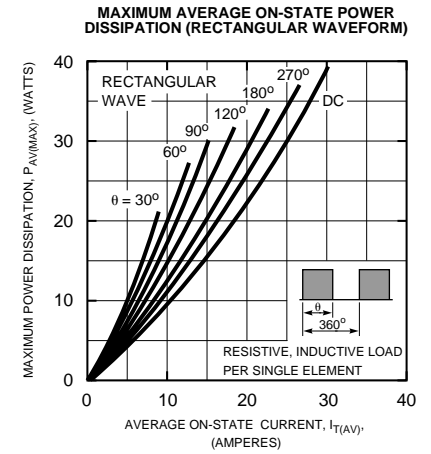
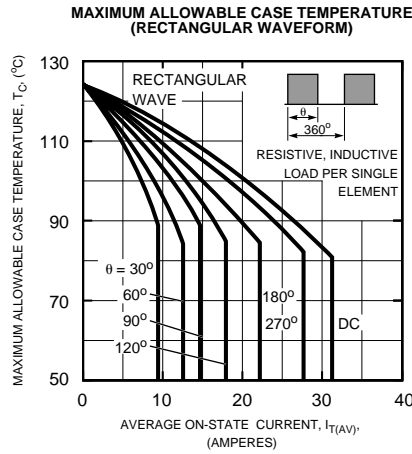
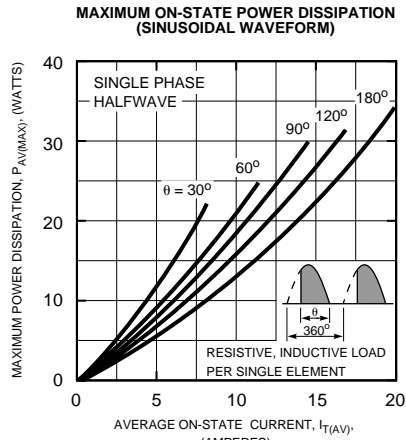
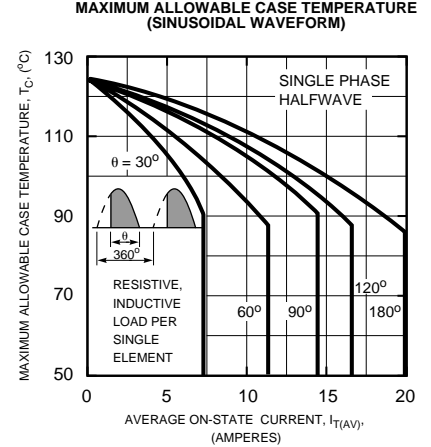
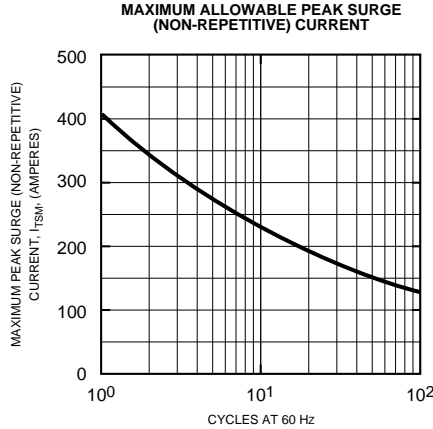
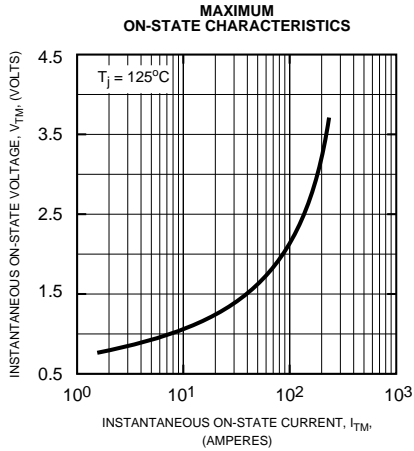

CT230802
Split Dual SCR POW-R-BLOK™ Modules
 20 Amperes/800 Volts

MAXIMUM ON-STATE POWER DISSIPATION (REVERSE PARALLEL CONNECTION)

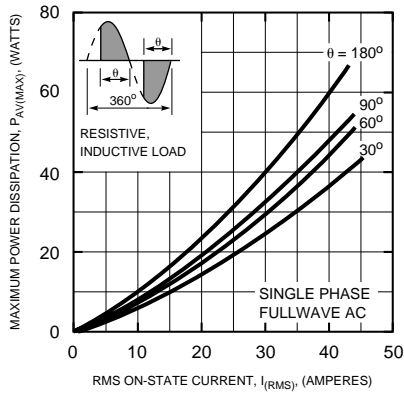

MAXIMUM ALLOWABLE CASE TEMPERATURE (SINGLE PHASE BRIDGE CONNECTION)

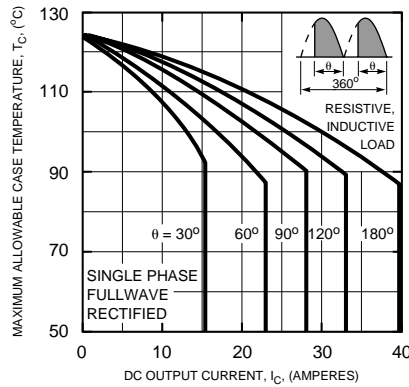

MAXIMUM ON-STATE POWER DISSIPATION (SINGLE PHASE BRIDGE CONNECTION)

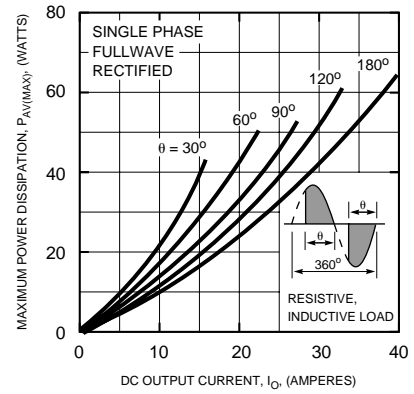

MAXIMUM ALLOWABLE CASE TEMPERATURE (THREE PHASE BRIDGE CONNECTION)

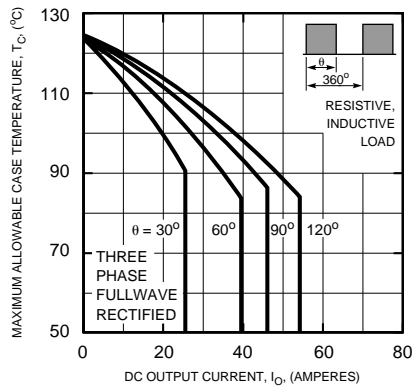

MAXIMUM ON-STATE POWER DISSIPATION (THREE PHASE BRIDGE CONNECTION)

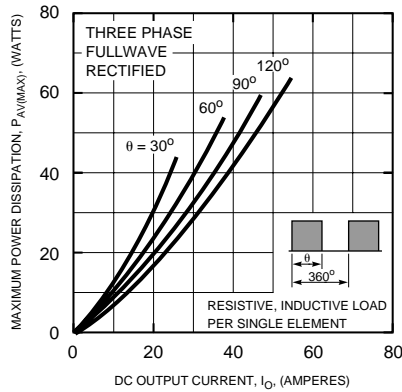



LittleDiode supplies new, hard to find or obsolete electronic components and semiconductors all over the world.

With over two million different components listed you are sure to find the part you need.

Feel free to visit us today at our online store:

LittleDiode.com

Looking forward to providing you with the best possible service.