

# LMV551/LMV552/LMV554

## 3 MHz, Micropower RRO Amplifiers

### General Description

The LMV551/LMV552/LMV554 are high performance, low power operational amplifiers implemented with National's advanced VIP50 process. They feature 3 MHz of bandwidth while consuming only 37  $\mu$ A of current per amplifier, which is an exceptional bandwidth to power ratio in this op amp class. These amplifiers are unity gain stable and provide an excellent solution for low power applications requiring a wide bandwidth.

The LMV551/LMV552/LMV554 have a rail-to-rail output stage and an input common mode range that extends below ground.

The LMV551/LMV552/LMV554 have an operating supply voltage range from 2.7V to 5.5V. These amplifiers can operate over a wide temperature range (-40°C to 125°C) making them a great choice for automotive applications, sensor applications as well as portable instrumentation applications. The LMV551 is offered in the ultra tiny 5-Pin SC70 and 5-Pin SOT-23 package. The LMV552 is offered in an 8-Pin MSOP package. The LMV554 is offered in the 14-Pin TSSOP.

### Features

(Typical 5V supply, unless otherwise noted.)

- Guaranteed 3V and 5.0V performance
- High unity gain bandwidth 3 MHz
- Supply current (per amplifier) 37  $\mu$ A
- CMRR 93 dB
- PSRR 90 dB
- Slew rate 1 V/ $\mu$ s
- Output swing with 100 k $\Omega$  load 70 mV from rail
- Total harmonic distortion 0.003% @ 1 kHz, 2 k $\Omega$
- Temperature range -40°C to 125°C

### Applications

- Active filter
- Portable equipment
- Automotive
- Battery powered systems
- Sensors and Instrumentation

### Typical Application

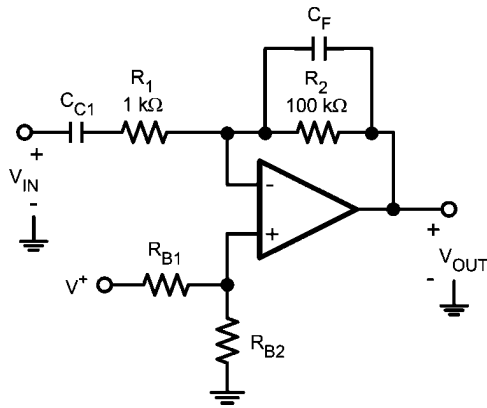

20152601

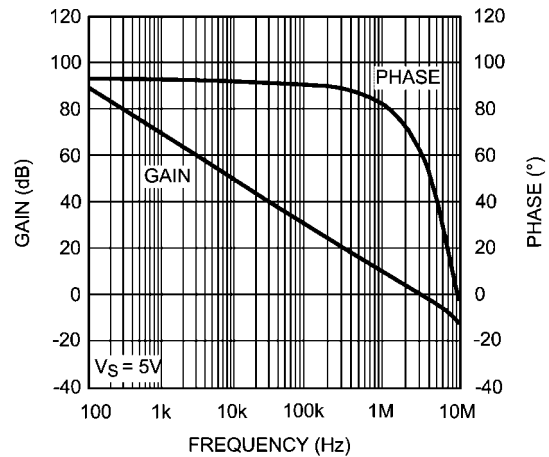

Open Loop Gain and Phase vs. Frequency

20152613

**Absolute Maximum Ratings** (Note 1)

If Military/Aerospace specified devices are required, please contact the National Semiconductor Sales Office/Distributors for availability and specifications.

## ESD Tolerance (Note 2)

Human Body Model

LMV551/LMV552/LMV554

2 kV

Machine Model

LMV551

100V

LMV552/LMV554

250V

 $V_{IN}$  Differential (@  $V^+ = 5V$ ) $\pm 2.5V$ Supply Voltage ( $V^+ - V^-$ )

6V

Voltage at Input/Output pins

 $V^+ + 0.3V, V^- - 0.3V$ 

Storage Temperature Range

 $-65^\circ C$  to  $150^\circ C$ 

Junction Temperature (Note 3)

 $150^\circ C$ 

Soldering Information

Infrared or Convection (20 sec)

 $235^\circ C$ 

Wave Soldering Lead Temp. (10 sec)

 $260^\circ C$ **Operating Ratings** (Note 1)

Temperature Range (Note 3)

 $-40^\circ C$  to  $125^\circ C$ Supply Voltage ( $V^+ - V^-$ )

2.7V to 5.5V

Package Thermal Resistance ( $\theta_{JA}$  (Note 3))

5-Pin SC70

 $456^\circ C/W$ 

5-Pin SOT-23

 $234^\circ C/W$ 

8-Pin MSOP

 $235^\circ C/W$ 

14-Pin TSSOP

 $160^\circ C/W$ **3V Electrical Characteristics**

Unless otherwise specified, all limits are guaranteed for  $T_A = 25^\circ C$ ,  $V^+ = 3V$ ,  $V^- = 0V$ ,  $V_{CM} = V^+/2 = V_O$ . **Boldface** limits apply at the temperature extremes. (Note 4)

Symbol	Parameter	Conditions	Min (Note 6)	Typ (Note 5)	Max (Note 6)	Units
$V_{OS}$	Input Offset Voltage			1	3 <b>4.5</b>	mV
TC $V_{OS}$	Input Offset Average Drift			3.3		$\mu V/^\circ C$
$I_B$	Input Bias Current	(Note 7)		20	38	nA
$I_{OS}$	Input Offset Current			1	20	nA
CMRR	Common Mode Rejection Ratio	$0V \leq V_{CM} \leq 2.0V$	74 <b>72</b>	92		dB
PSRR	Power Supply Rejection Ratio	$3.0 \leq V^+ \leq 5V$ , $V_{CM} = 0.5V$	LMV551/LMV552	80 <b>78</b>	92	dB
			LMV554	78 <b>76</b>		
		$2.7 \leq V^+ \leq 5.5V$ , $V_{CM} = 0.5V$	LMV551/LMV552	80 <b>78</b>	92	
			LMV554	78 <b>76</b>		
CMVR	Input Common-Mode Voltage Range	CMRR $\geq 68$ dB <b>CMRR <math>\geq 60</math> dB</b>	0 <b>0</b>		2.1 <b>2.1</b>	V
$A_{VOL}$	Large Signal Voltage Gain	$0.4 \leq V_O \leq 2.6$ , $R_L = 100$ k $\Omega$ to $V^+/2$	LMV551/LMV552	81 <b>78</b>	90	dB
			LMV554	79 <b>77</b>		
		$0.4 \leq V_O \leq 2.6$ , $R_L = 10$ k $\Omega$ to $V^+/2$		71 <b>68</b>	80	
$V_O$	Output Swing High	$R_L = 100$ k $\Omega$ to $V^+/2$		40	48 <b>58</b>	mV from rail
		$R_L = 10$ k $\Omega$ to $V^+/2$		85	100 <b>120</b>	
	Output Swing Low	$R_L = 100$ k $\Omega$ to $V^+/2$		50	65 <b>77</b>	
		$R_L = 10$ k $\Omega$ to $V^+/2$		95	110 <b>130</b>	
$I_{SC}$	Output Short Circuit Current	Sourcing (Note 9)		10		mA
		Sinking (Note 9)		25		

Symbol	Parameter	Conditions	Min (Note 6)	Typ (Note 5)	Max (Note 6)	Units
$I_S$	Supply Current per Amplifier			34	42 <b>52</b>	$\mu\text{A}$
SR	Slew Rate	$A_V = +1$ , 10% to 90% (Note 8)		1		$\text{V}/\mu\text{s}$
$\Phi_m$	Phase Margin	$R_L = 10\text{ k}\Omega$ , $C_L = 20\text{ pF}$		75		Deg
GBW	Gain Bandwidth Product			3		MHz
$e_n$	Input-Referred Voltage Noise	$f = 100\text{ kHz}$		70		$\text{nV}/\sqrt{\text{Hz}}$
		$f = 1\text{ kHz}$		70		
$i_n$	Input-Referred Current Noise	$f = 100\text{ kHz}$		0.1		$\text{pA}/\sqrt{\text{Hz}}$
		$f = 1\text{ kHz}$		0.15		
THD	Total Harmonic Distortion	$f = 1\text{ kHz}$ , $A_V = 2$ , $R_L = 2\text{ k}\Omega$		0.003		%

## 5V Electrical Characteristics

Unless otherwise specified, all limits are guaranteed for  $T_A = 25^\circ\text{C}$ ,  $V^+ = 5\text{V}$ ,  $V^- = 0\text{V}$ ,  $V_{\text{CM}} = V^+/2 = V_O$ . **Boldface** limits apply at the temperature extremes.

Symbol	Parameter	Conditions	Min (Note 6)	Typ (Note 5)	Max (Note 6)	Units
$V_{\text{OS}}$	Input Offset Voltage			1	3.0 <b>4.5</b>	mV
TC $V_{\text{OS}}$	Input Offset Average Drift			3.3		$\mu\text{V}/^\circ\text{C}$
$I_B$	Input Bias Current	(Note 7)		20	38	nA
$I_{\text{OS}}$	Input Offset Current			1	20	nA
CMRR	Common Mode Rejection Ratio	$0 \leq V_{\text{CM}} \leq 4.0\text{V}$	76 <b>74</b>	93		dB
PSRR	Power Supply Rejection Ratio	$3\text{V} \leq V^+ \leq 5\text{V}$ to $V_{\text{CM}} = 0.5\text{V}$	78 <b>75</b>	90		dB
		$2.7\text{V} \leq V^+ \leq 5.5\text{V}$ to $V_{\text{CM}} = 0.5\text{V}$	78 <b>75</b>	90		
CMVR	Input Common-Mode Voltage Range	CMRR $\geq 68\text{ dB}$ CMRR $\geq 60\text{ dB}$	0 <b>0</b>		4.1 <b>4.1</b>	V
$A_{\text{VOL}}$	Large Signal Voltage Gain	$0.4 \leq V_O \leq 4.6$ , $R_L = 100\text{ k}\Omega$ to $V^+/2$	78 <b>75</b>	90		dB
		$0.4 \leq V_O \leq 4.6$ , $R_L = 10\text{ k}\Omega$ to $V^+/2$	75 <b>72</b>	80		
$V_O$	Output Swing High	$R_L = 100\text{ k}\Omega$ to $V^+/2$		70	92 <b>122</b>	mV from rail
		$R_L = 10\text{ k}\Omega$ to $V^+/2$		125	155 <b>210</b>	
	Output Swing Low	$R_L = 100\text{ k}\Omega$ to $V^+/2$		60	70 <b>82</b>	
		$R_L = 10\text{ k}\Omega$ to $V^+/2$		110	130 <b>155</b>	
$I_{\text{SC}}$	Output Short Circuit Current	Sourcing (Note 9)		10		mA
		Sinking (Note 9)		25		
$I_S$	Supply Current Per Amplifier			37	46 <b>54</b>	$\mu\text{A}$
SR	Slew Rate	$A_V = +1$ , $V_O = 1\text{ V}_{\text{PP}}$ 10% to 90% (Note 8)		1		$\text{V}/\mu\text{s}$
$\Phi_m$	Phase Margin	$R_L = 10\text{ k}\Omega$ , $C_L = 20\text{ pF}$		75		Deg
GBW	Gain Bandwidth Product			3		MHz

Symbol	Parameter	Conditions	Min (Note 6)	Typ (Note 5)	Max (Note 6)	Units
$e_n$	Input-Referred Voltage Noise	$f = 100 \text{ kHz}$		70		$\text{nV}/\sqrt{\text{Hz}}$
		$f = 1 \text{ kHz}$		70		
$i_n$	Input-Referred Current Noise	$f = 100 \text{ kHz}$		0.1		$\text{pA}/\sqrt{\text{Hz}}$
		$f = 1 \text{ kHz}$		0.15		
THD	Total Harmonic Distortion	$f = 1 \text{ kHz}, A_V = 2, R_L = 2 \text{ k}\Omega$		0.003		%

**Note 1:** Absolute Maximum Ratings indicate limits beyond which damage to the device may occur. Operating Ratings indicate conditions for which the device is intended to be functional, but specific performance is not guaranteed. For guaranteed specifications and the test conditions, see the Electrical Characteristics Tables.

**Note 2:** Human Body Model, applicable std. MIL-STD-883, Method 3015.7. Machine Model, applicable std. JESD22-A115-A (ESD MM std. of JEDEC) Field-Induced Charge-Device Model, applicable std. JESD22-C101-C (ESD FICDM std. of JEDEC).

**Note 3:** The maximum power dissipation is a function of  $T_{J(\text{MAX})}$ ,  $\theta_{JA}$ . The maximum allowable power dissipation at any ambient temperature is  $P_D = (T_{J(\text{MAX})} - T_A) / \theta_{JA}$ . All numbers apply for packages soldered directly onto a PC board.

**Note 4:** Electrical Table values apply only for factory testing conditions at the temperature indicated. Factory testing conditions result in very limited self-heating of the device such that  $T_J = T_A$ . No guarantee of parametric performance is indicated in the electrical tables under conditions of internal self-heating where  $T_J > T_A$ .

**Note 5:** Typical values represent the most likely parametric norm as determined at the time of characterization. Actual typical values may vary over time and will also depend on the application and configuration. The typical values are not tested and are not guaranteed on shipped production material.

**Note 6:** Limits are 100% production tested at 25°C. Limits over the operating temperature range are guaranteed through correlations using statistical quality control (SQC) method.

**Note 7:** Positive current corresponds to current flowing into the device.

**Note 8:** Slew rate is the average of the rising and falling slew rates.

**Note 9:** The part is not short circuit protected and is not recommended for operation with heavy resistive loads.

## Connection Diagrams

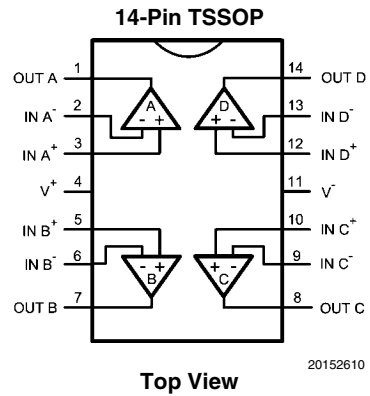
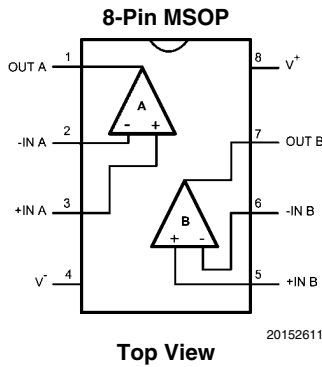
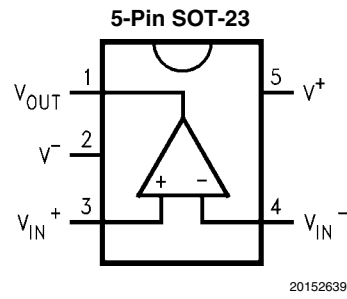
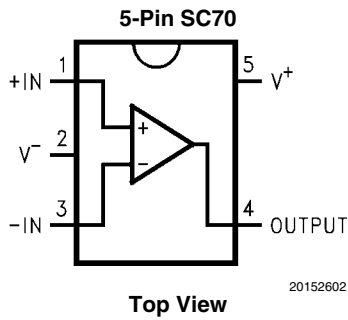

## Ordering Information

Package	Part Number	Package Marking	Transport Media	NSC Drawing
5-Pin SC70	LMV551MG	A94	1k Units Tape and Reel	MAA05A
	LMV551MGX		3k Units Tape and Reel	
5-Pin SOT-23	LMV551MF	AF3A	1k Units Tape and Reel	MF05A
	LMV551MFX		3k Units Tape and Reel	
8-Pin MSOP	LMV552MM	AH3A	1k Units Tape and Reel	MUA08A
	LMV552MMX		3.5k Units Tape and Reel	
14-Pin TSSOP	LMV554MT	LMV554MT	94 Units/Rail	MTC14
	LMV554MTX		2.5k Units Tape and Reel	

# Typical Performance Characteristics

Open Loop Gain and Phase with Capacitive Load

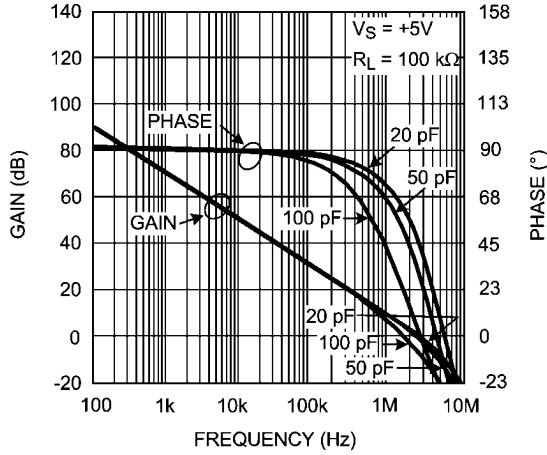

20152614

Open Loop Gain and Phase with Resistive Load

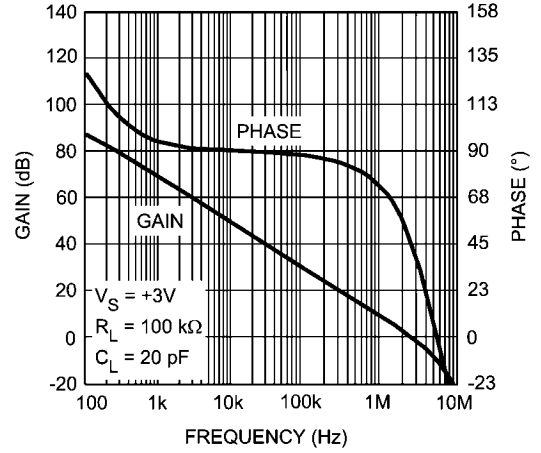

20152615

Open Loop Gain and Phase with Resistive Load

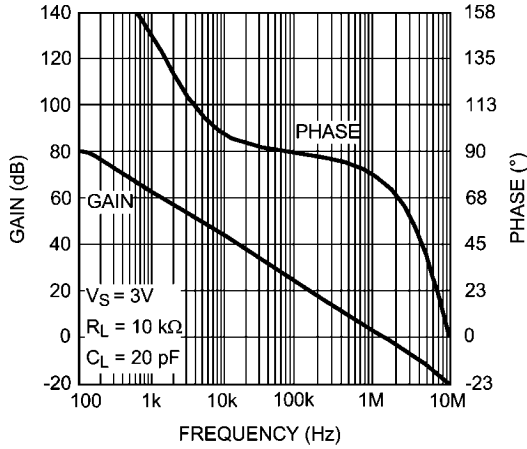

20152616

Open Loop Gain and Phase with Resistive Load

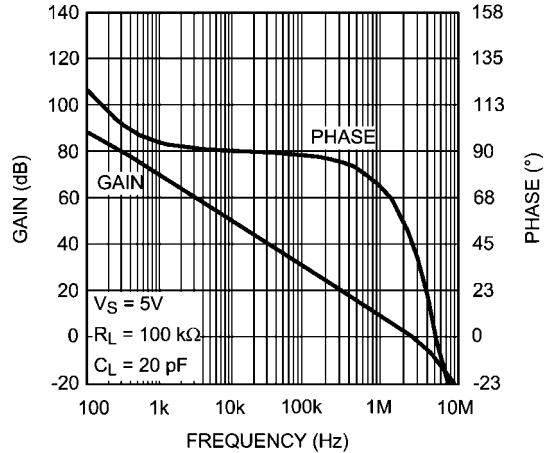

20152617

Open Loop Gain and Phase with Resistive Load

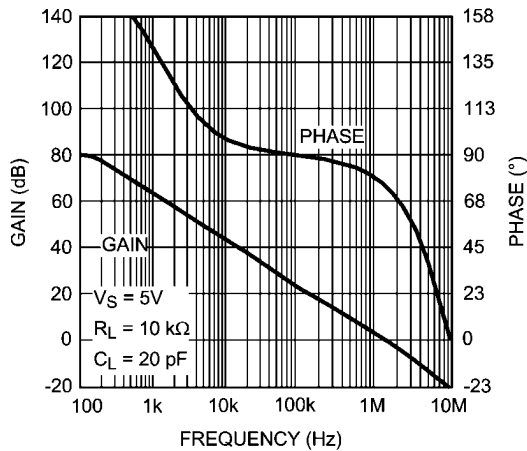

20152618

Slew Rate vs. Supply voltage

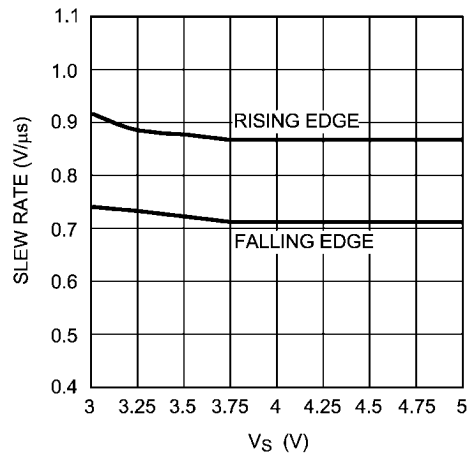

20152619

**Small Signal Transient Response**

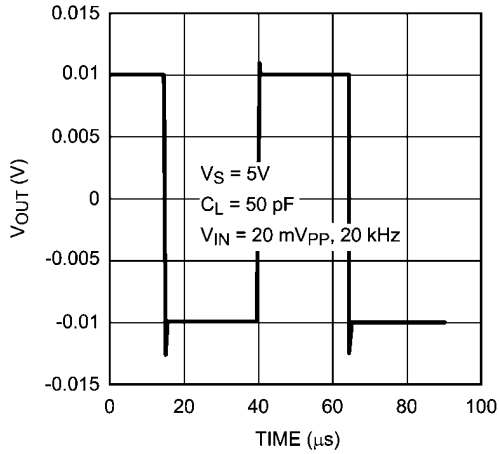

20152620

**Large Signal Transient Response**

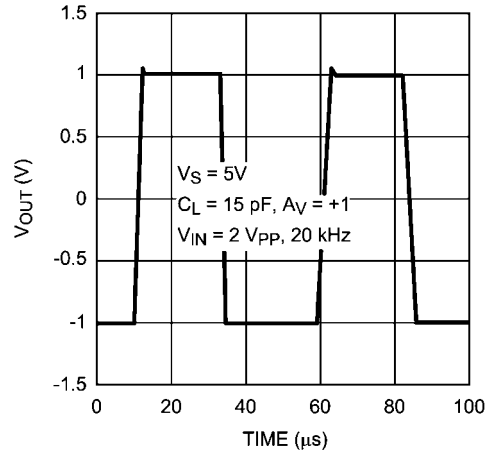

20152621

**Small Signal Transient Response**

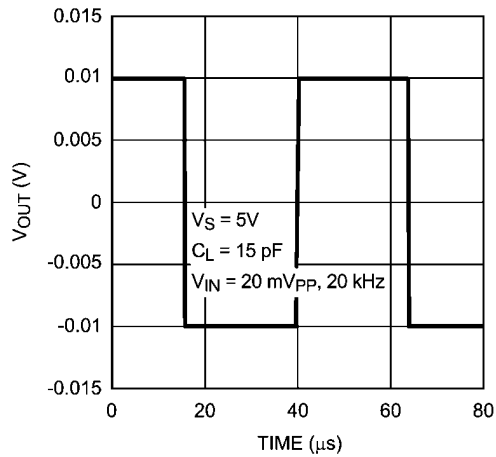

20152622

**Input Referred Noise vs. Frequency**

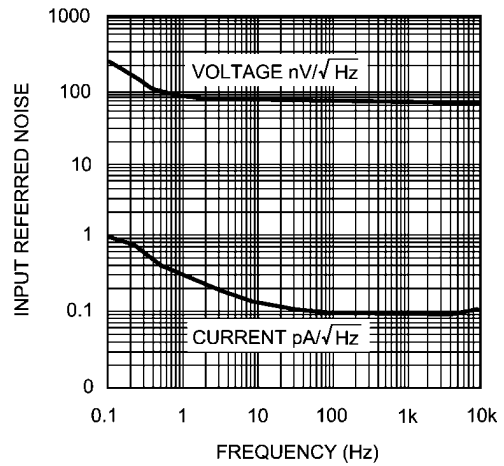

20152623

**THD+N vs. Amplitude @ 3V**

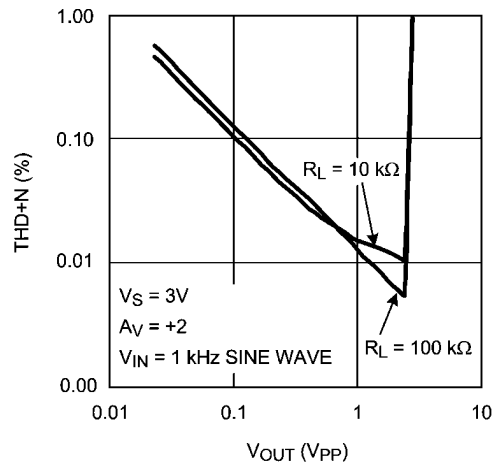

20152624

**THD+N vs. Amplitude @ 5V**

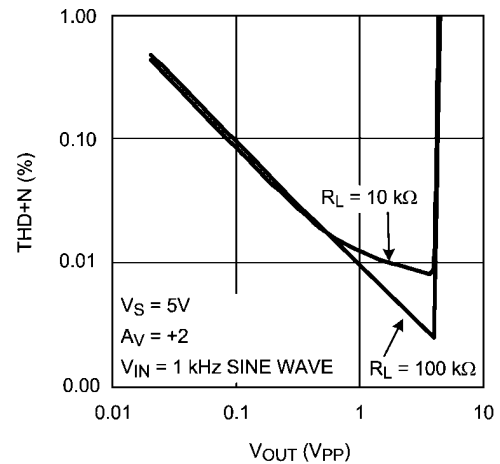

20152625

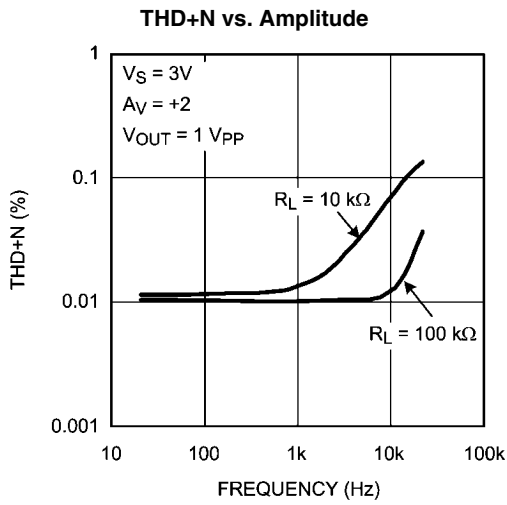

20152626

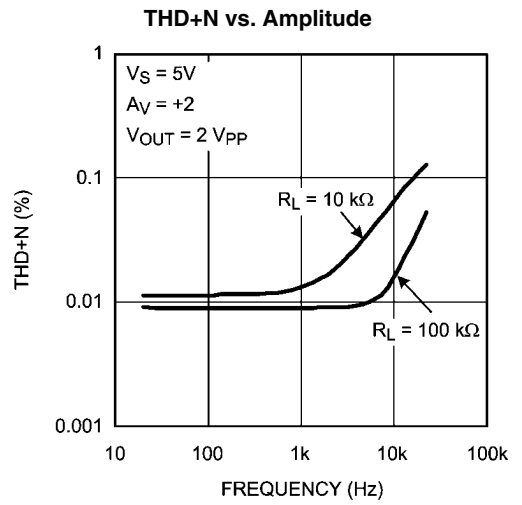

20152627

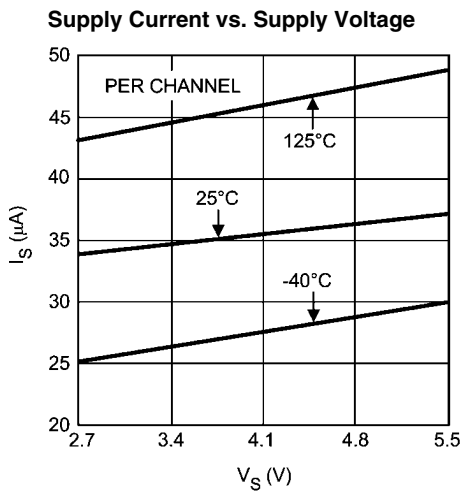

20152628

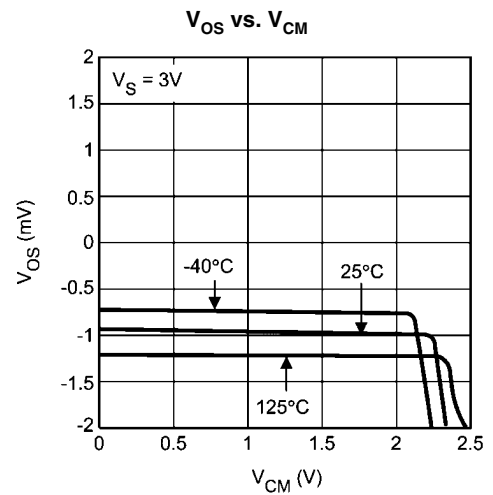

20152629

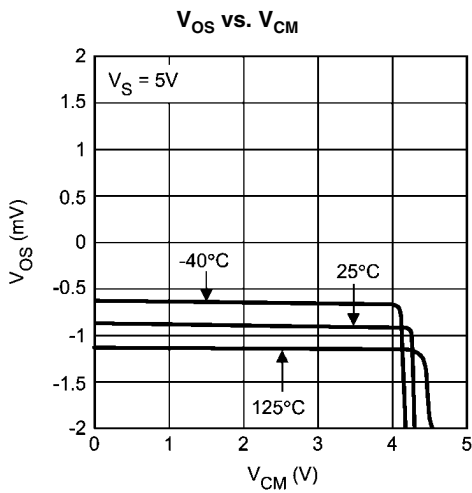

20152630

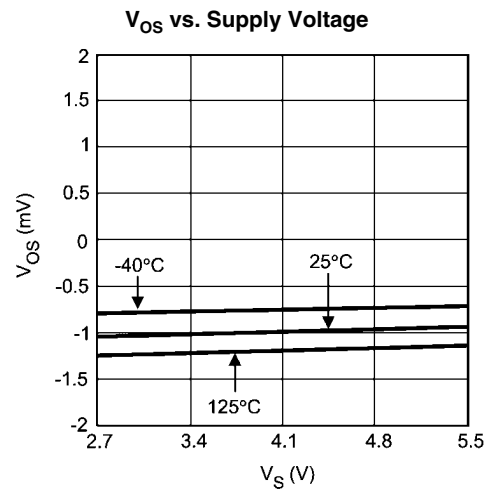

20152631

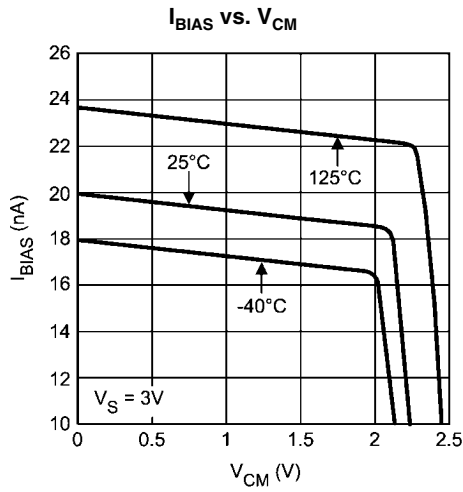

20152632

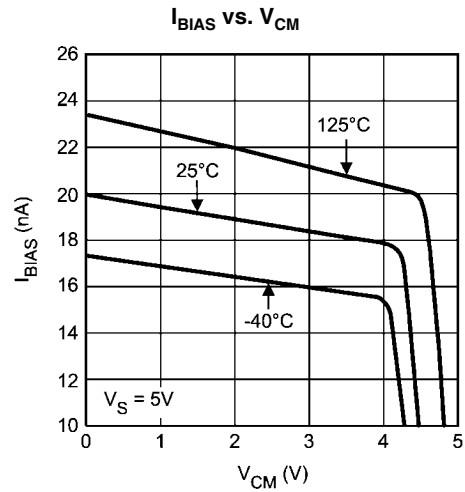

20152633

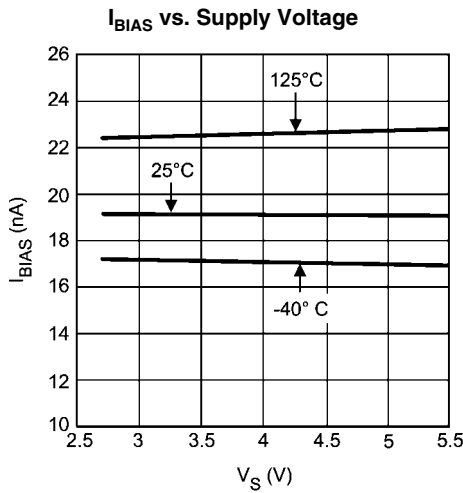

20152634

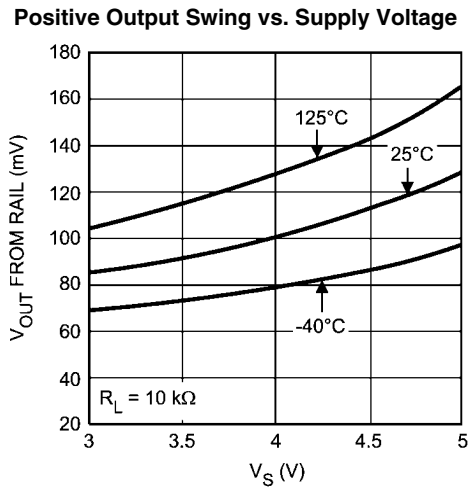

20152635

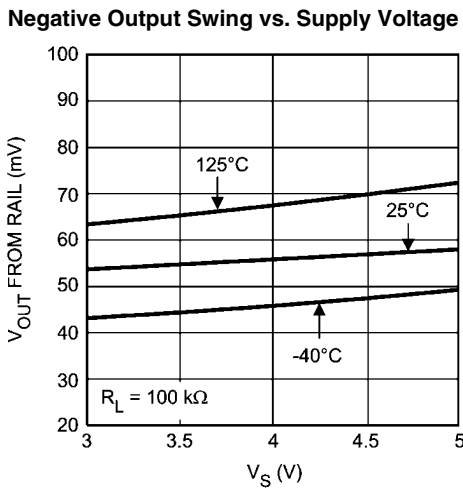

20152636

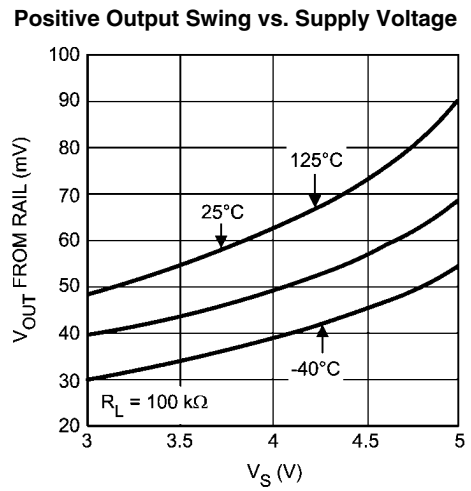

20152637

### Negative Output Swing vs. Supply Voltage

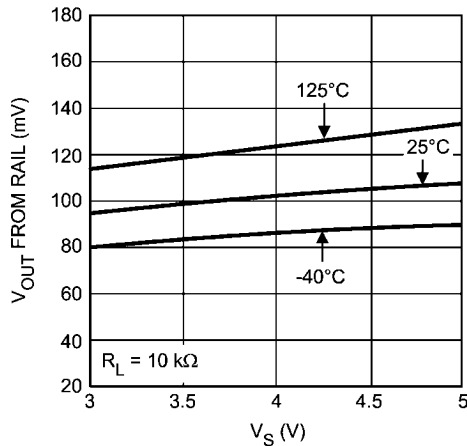

20152638

## Applications Information

### ADVANTAGES OF THE LMV551/LMV552/LMV554

#### Low Voltage and Low Power Operation

The LMV551/LMV552/LMV554 have performance guaranteed at supply voltages of 3V and 5V and are guaranteed to be operational at all supply voltages between 2.7V and 5.5V. For this supply voltage range, the LMV551/LMV552/LMV554 draw the extremely low supply current of less than 37  $\mu$ A per amp.

#### Wide Bandwidth

The bandwidth to power ratio of 3 MHz to 37  $\mu$ A per amplifier is one of the best bandwidth to power ratios ever achieved. This makes these devices ideal for low power signal processing applications such as portable media players and instrumentation.

#### Low Input Referred Noise

The LMV551/LMV552/LMV554 provide a flatband input referred voltage noise density of 70 nV/ $\sqrt{\text{Hz}}$ , which is significantly better than the noise performance expected from an ultra low power op amp. They also feature the exceptionally low 1/f noise corner frequency of 4 Hz. This noise specification makes the LMV551/LMV552/LMV554 ideal for low power applications such as PDAs and portable sensors.

#### Ground Sensing and Rail-to-Rail Output

The LMV551/LMV552/LMV554 each have a rail-to-rail output stage, which provides the maximum possible output dynamic range. This is especially important for applications requiring a large output swing. The input common mode range includes the negative supply rail which allows direct sensing at ground in a single supply operation.

#### Small Size

The small footprints of the LMV551/LMV552/LMV554 packages save space on printed circuit boards, and enable the design of smaller and more compact electronic products. Long traces between the signal source and the op amp make the signal path susceptible to noise. By using a physically smaller package, the amplifiers can be placed closer to the signal source, reducing noise pickup and enhancing signal integrity.

### STABILITY OF OP AMP CIRCUITS

#### Stability and Capacitive Loading

As seen in the Phase Margin vs. Capacitive Load graph, the phase margin reduces significantly for  $C_L$  greater than 100 pF. This is because the op amp is designed to provide the maximum bandwidth possible for a low supply current. Stabilizing them for higher capacitive loads would have required either a drastic increase in supply current, or a large internal compensation capacitance, which would have reduced the bandwidth of the op amp. Hence, if the LMV551/LMV552/LMV554 are to be used for driving higher capacitive loads, they will have to be externally compensated.

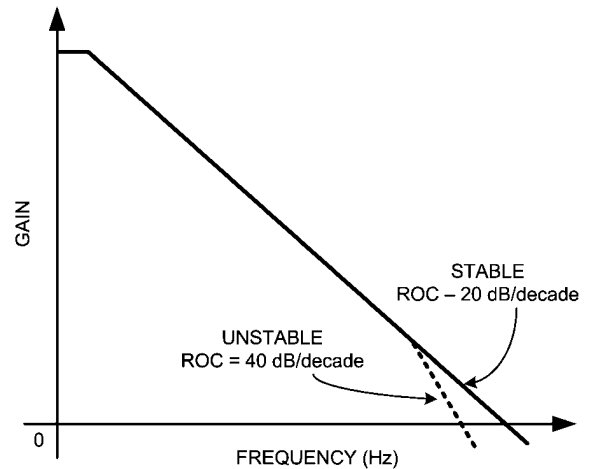

20152603

FIGURE 1. Gain vs. Frequency for an Op Amp

An op amp, ideally, has a dominant pole close to DC, which causes its gain to decay at the rate of 20 dB/decade with respect to frequency. If this rate of decay, also known as the rate of closure (ROC), remains the same until the op amp's unity gain bandwidth, the op amp is stable. If, however, a large capacitance is added to the output of the op amp, it combines with the output impedance of the op amp to create another pole in its frequency response before its unity gain frequency (Figure 1). This increases the ROC to 40 dB/decade and causes instability.

In such a case a number of techniques can be used to restore stability to the circuit. The idea behind all these schemes is to modify the frequency response such that it can be restored to an ROC of 20 dB/decade, which ensures stability.

**In the Loop Compensation**

Figure 2 illustrates a compensation technique, known as 'in the loop' compensation, that employs an RC feedback circuit within the feedback loop to stabilize a non-inverting amplifier configuration. A small series resistance,  $R_S$ , is used to isolate the amplifier output from the load capacitance,  $C_L$ , and a small capacitance,  $C_F$ , is inserted across the feedback resistor to bypass  $C_L$  at higher frequencies.

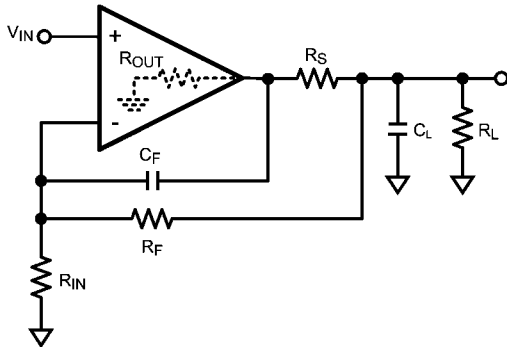

20152604

**FIGURE 2. In the Loop Compensation**

The values for  $R_S$  and  $C_F$  are decided by ensuring that the zero attributed to  $C_F$  lies at the same frequency as the pole attributed to  $C_L$ . This ensures that the effect of the second pole on the transfer function is compensated for by the presence of the zero, and that the ROC is maintained at 20 dB/decade. For the circuit shown in Figure 2 the values of  $R_S$  and  $C_F$  are given by Equation 1. Values of  $R_S$  and  $C_F$  required for maintaining stability for different values of  $C_L$ , as well as the phase margins obtained, are shown in Table 1.  $R_F$ ,  $R_{IN}$ , and  $R_L$  are to be 10 k $\Omega$ , while  $R_{OUT}$  is 340 $\Omega$ .

$$R_S = \frac{R_{OUT} R_{IN}}{R_F}$$

$$C_F = \left( 1 + \frac{1}{A_{CL}} \right) \left( \frac{R_F + 2R_{IN}}{R_F^2} \right) C_L R_{OUT} \tag{1}$$

**TABLE 1.**

$C_L$ (pF)	$R_S$ ( $\Omega$ )	$C_F$ (pF)	Phase Margin ( $^\circ$ )
50	340	8	47
100	340	15	42
150	340	22	40

Although this methodology provides circuit stability for any load capacitance, it does so at the price of bandwidth. The closed loop bandwidth of the circuit is now limited by  $R_F$  and  $C_F$ .

**Compensation by External Resistor**

In some applications it is essential to drive a capacitive load without sacrificing bandwidth. In such a case, in the loop compensation is not viable. A simpler scheme for compensation

is shown in Figure 3. A resistor,  $R_{ISO}$ , is placed in series between the load capacitance and the output. This introduces a zero in the circuit transfer function, which counteracts the effect of the pole formed by the load capacitance and ensures stability. The value of  $R_{ISO}$  to be used should be decided depending on the size of  $C_L$  and the level of performance desired. Values ranging from 5 $\Omega$  to 50 $\Omega$  are usually sufficient to ensure stability. A larger value of  $R_{ISO}$  will result in a system with less ringing and overshoot, but will also limit the output swing and the short circuit current of the circuit.

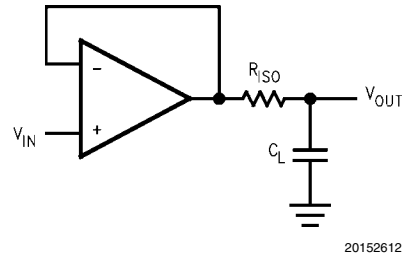

20152612

**FIGURE 3. Compensation by Isolation Resistor**

**Typical Application**

**ACTIVE FILTERS**

With a wide unity gain bandwidth of 3 MHz, low input referred noise density and a low power supply current, the LMV551/LMV552/LMV554 are well suited for low-power filtering applications. Active filter topologies, such as the Sallen-Key low pass filter shown in Figure 4, are very versatile, and can be used to design a wide variety of filters (Chebyshev, Butterworth or Bessel). The Sallen-Key topology, in particular, can be used to attain a wide range of Q, by using positive feedback to reject the undesired frequency range.

In the circuit shown in Figure 4, the two capacitors appear as open circuits at lower frequencies and the signal is simply buffered to the output. At high frequencies the capacitors appear as short circuits and the signal is shunted to ground by one of the capacitors before it can be amplified. Near the cut-off frequency, where the impedance of the capacitances is on the same order as  $R_G$  and  $R_F$ , positive feedback through the other capacitor allows the circuit to attain the desired Q.

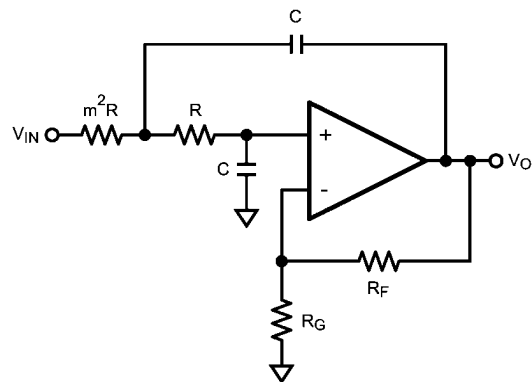

20152609

**FIGURE 4. Sallen-Key Filter**

**Physical Dimensions** inches (millimeters) unless otherwise noted

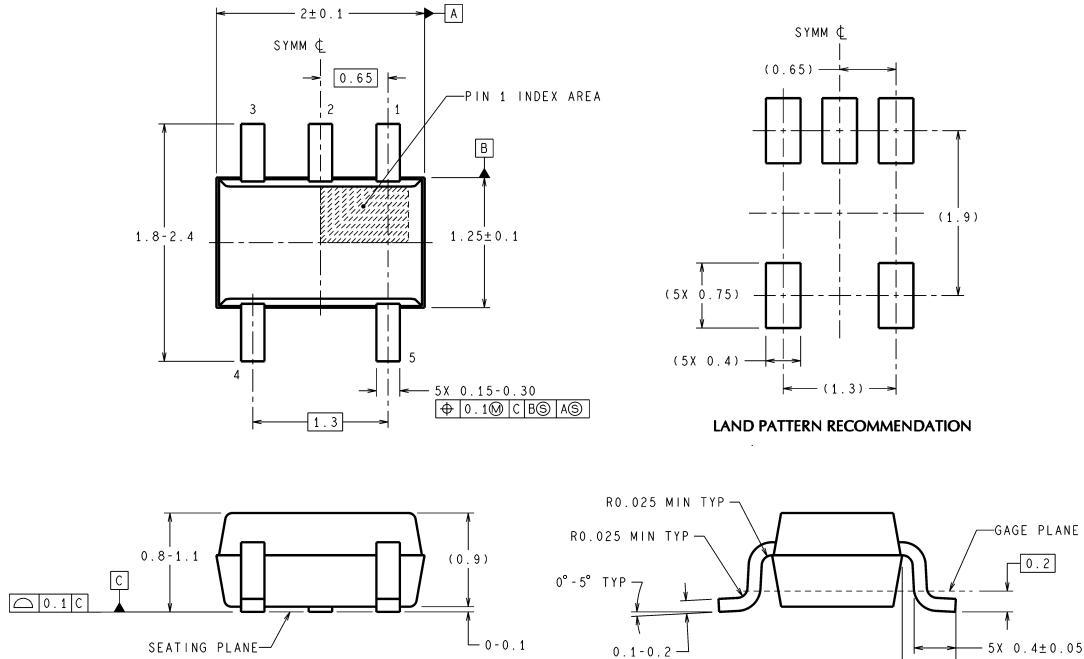

DIMENSIONS ARE IN MILLIMETERS  
DIMENSIONS IN ( ) FOR REFERENCE ONLY

**5-Pin SC70**  
**NS Package Number MAA05A**

MAA05A (Rev D)

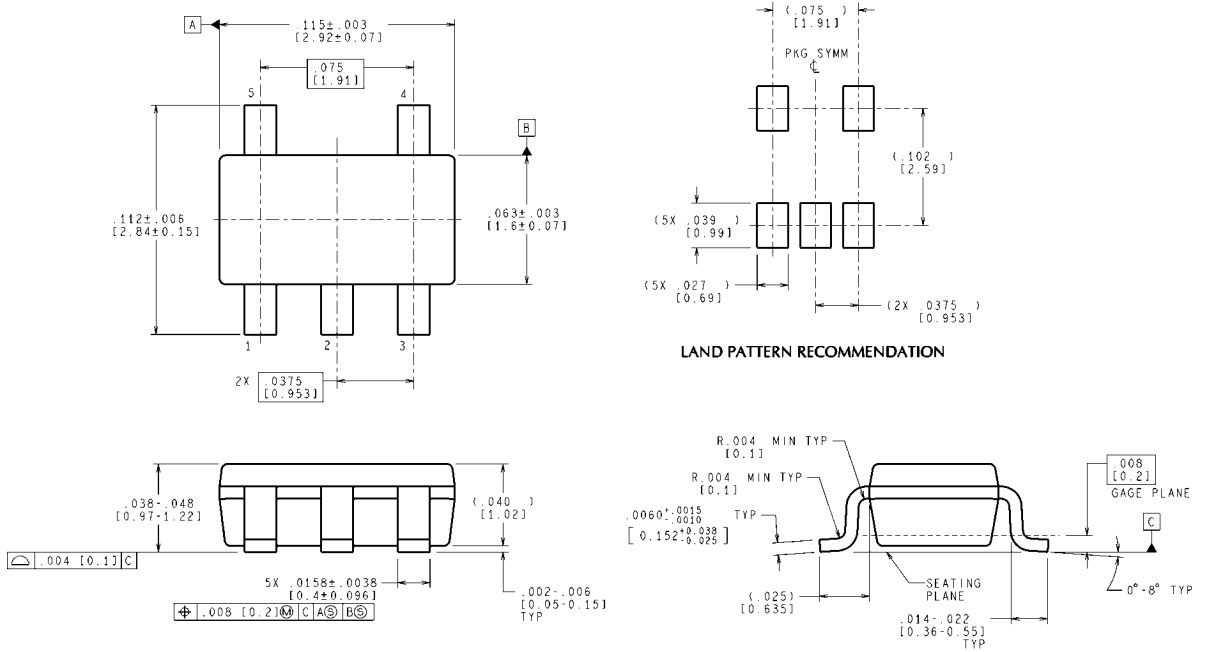

CONTROLLING DIMENSION IS INCH  
VALUES IN [ ] ARE MILLIMETERS  
DIMENSIONS IN ( ) FOR REFERENCE ONLY

**5-Pin SOT-23**  
**NS Package Number MF05A**

MF05A (Rev C)

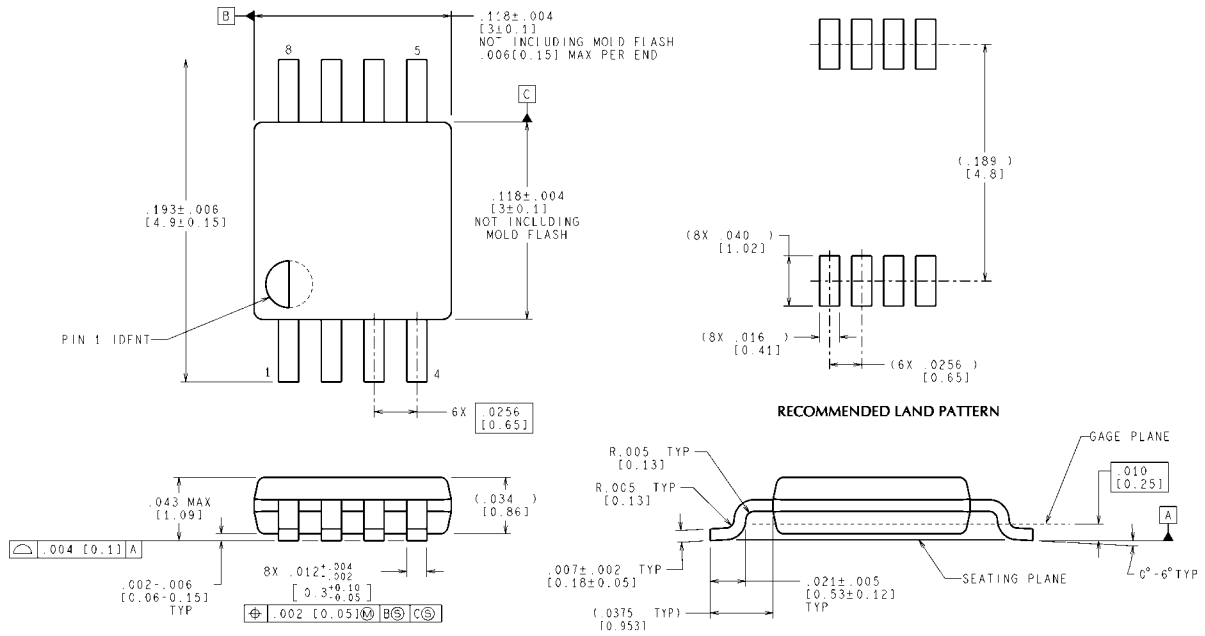

CONTROLLING DIMENSION IS INCH  
VALUES IN [ ] ARE MILLIMETERS

MUA08A (Rev F)

**8-Pin MSOP**  
**NS Package Number MUA08A**

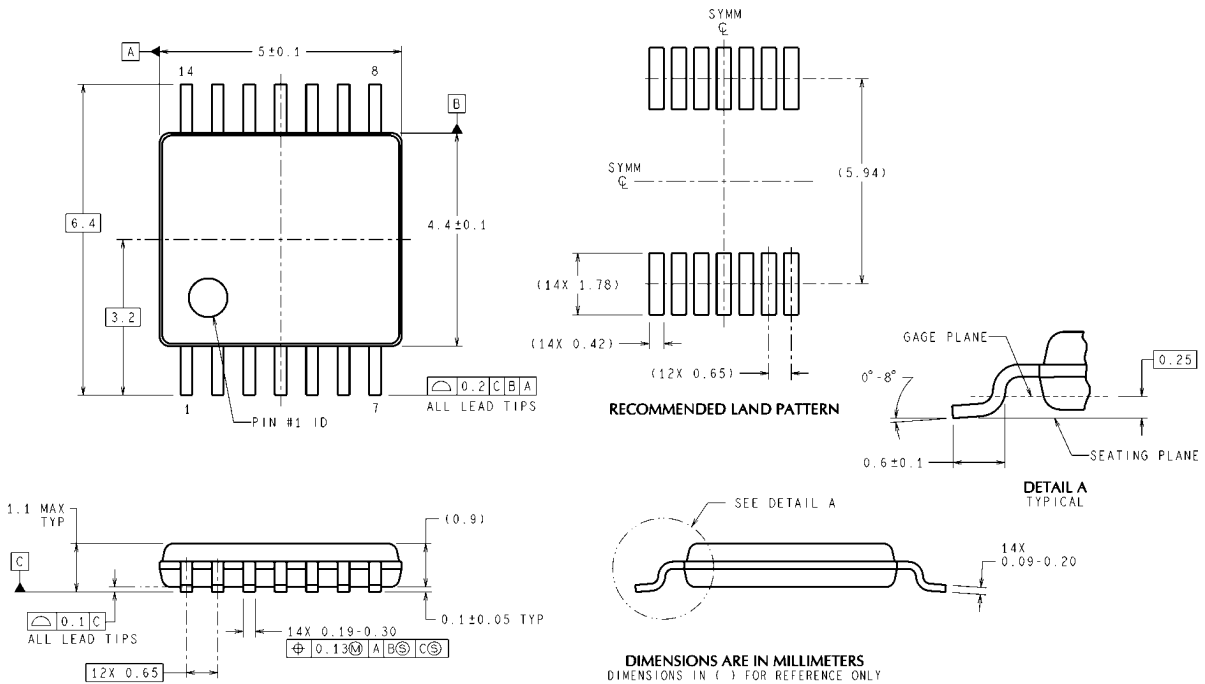

DIMENSIONS ARE IN MILLIMETERS  
DIMENSIONS IN ( ) FOR REFERENCE ONLY

MTC14 (Rev D)

**14-Pin TSSOP**  
**NS Package Number MTC14**

## Notes

For more National Semiconductor product information and proven design tools, visit the following Web sites at:

Products		Design Support	
Amplifiers	<a href="http://www.national.com/amplifiers">www.national.com/amplifiers</a>	WEBENCH	<a href="http://www.national.com/webench">www.national.com/webench</a>
Audio	<a href="http://www.national.com/audio">www.national.com/audio</a>	Analog University	<a href="http://www.national.com/AU">www.national.com/AU</a>
Clock Conditioners	<a href="http://www.national.com/timing">www.national.com/timing</a>	App Notes	<a href="http://www.national.com/appnotes">www.national.com/appnotes</a>
Data Converters	<a href="http://www.national.com/adc">www.national.com/adc</a>	Distributors	<a href="http://www.national.com/contacts">www.national.com/contacts</a>
Displays	<a href="http://www.national.com/displays">www.national.com/displays</a>	Green Compliance	<a href="http://www.national.com/quality/green">www.national.com/quality/green</a>
Ethernet	<a href="http://www.national.com/ethernet">www.national.com/ethernet</a>	Packaging	<a href="http://www.national.com/packaging">www.national.com/packaging</a>
Interface	<a href="http://www.national.com/interface">www.national.com/interface</a>	Quality and Reliability	<a href="http://www.national.com/quality">www.national.com/quality</a>
LVDS	<a href="http://www.national.com/lvds">www.national.com/lvds</a>	Reference Designs	<a href="http://www.national.com/refdesigns">www.national.com/refdesigns</a>
Power Management	<a href="http://www.national.com/power">www.national.com/power</a>	Feedback	<a href="http://www.national.com/feedback">www.national.com/feedback</a>
Switching Regulators	<a href="http://www.national.com/switchers">www.national.com/switchers</a>		
LDOs	<a href="http://www.national.com/ldo">www.national.com/ldo</a>		
LED Lighting	<a href="http://www.national.com/led">www.national.com/led</a>		
PowerWise	<a href="http://www.national.com/powerwise">www.national.com/powerwise</a>		
Serial Digital Interface (SDI)	<a href="http://www.national.com/sdi">www.national.com/sdi</a>		
Temperature Sensors	<a href="http://www.national.com/tempsensors">www.national.com/tempsensors</a>		
Wireless (PLL/VCO)	<a href="http://www.national.com/wireless">www.national.com/wireless</a>		

THE CONTENTS OF THIS DOCUMENT ARE PROVIDED IN CONNECTION WITH NATIONAL SEMICONDUCTOR CORPORATION ("NATIONAL") PRODUCTS. NATIONAL MAKES NO REPRESENTATIONS OR WARRANTIES WITH RESPECT TO THE ACCURACY OR COMPLETENESS OF THE CONTENTS OF THIS PUBLICATION AND RESERVES THE RIGHT TO MAKE CHANGES TO SPECIFICATIONS AND PRODUCT DESCRIPTIONS AT ANY TIME WITHOUT NOTICE. NO LICENSE, WHETHER EXPRESS, IMPLIED, ARISING BY ESTOPPEL OR OTHERWISE, TO ANY INTELLECTUAL PROPERTY RIGHTS IS GRANTED BY THIS DOCUMENT.

TESTING AND OTHER QUALITY CONTROLS ARE USED TO THE EXTENT NATIONAL DEEMS NECESSARY TO SUPPORT NATIONAL'S PRODUCT WARRANTY. EXCEPT WHERE MANDATED BY GOVERNMENT REQUIREMENTS, TESTING OF ALL PARAMETERS OF EACH PRODUCT IS NOT NECESSARILY PERFORMED. NATIONAL ASSUMES NO LIABILITY FOR APPLICATIONS ASSISTANCE OR BUYER PRODUCT DESIGN. BUYERS ARE RESPONSIBLE FOR THEIR PRODUCTS AND APPLICATIONS USING NATIONAL COMPONENTS. PRIOR TO USING OR DISTRIBUTING ANY PRODUCTS THAT INCLUDE NATIONAL COMPONENTS, BUYERS SHOULD PROVIDE ADEQUATE DESIGN, TESTING AND OPERATING SAFEGUARDS.

EXCEPT AS PROVIDED IN NATIONAL'S TERMS AND CONDITIONS OF SALE FOR SUCH PRODUCTS, NATIONAL ASSUMES NO LIABILITY WHATSOEVER, AND NATIONAL DISCLAIMS ANY EXPRESS OR IMPLIED WARRANTY RELATING TO THE SALE AND/OR USE OF NATIONAL PRODUCTS INCLUDING LIABILITY OR WARRANTIES RELATING TO FITNESS FOR A PARTICULAR PURPOSE, MERCHANTABILITY, OR INFRINGEMENT OF ANY PATENT, COPYRIGHT OR OTHER INTELLECTUAL PROPERTY RIGHT.

### LIFE SUPPORT POLICY

**NATIONAL'S PRODUCTS ARE NOT AUTHORIZED FOR USE AS CRITICAL COMPONENTS IN LIFE SUPPORT DEVICES OR SYSTEMS WITHOUT THE EXPRESS PRIOR WRITTEN APPROVAL OF THE CHIEF EXECUTIVE OFFICER AND GENERAL COUNSEL OF NATIONAL SEMICONDUCTOR CORPORATION.** As used herein:

Life support devices or systems are devices which (a) are intended for surgical implant into the body, or (b) support or sustain life and whose failure to perform when properly used in accordance with instructions for use provided in the labeling can be reasonably expected to result in a significant injury to the user. A critical component is any component in a life support device or system whose failure to perform can be reasonably expected to cause the failure of the life support device or system or to affect its safety or effectiveness.

National Semiconductor and the National Semiconductor logo are registered trademarks of National Semiconductor Corporation. All other brand or product names may be trademarks or registered trademarks of their respective holders.

Copyright© 2008 National Semiconductor Corporation

For the most current product information visit us at [www.national.com](http://www.national.com)



**National Semiconductor Americas Technical Support Center**  
 Email: [support@nsc.com](mailto:support@nsc.com)  
 Tel: 1-800-272-9959

**National Semiconductor Europe Technical Support Center**  
 Email: [europe.support@nsc.com](mailto:europe.support@nsc.com)  
 German Tel: +49 (0) 180 5010 771  
 English Tel: +44 (0) 870 850 4288

**National Semiconductor Asia Pacific Technical Support Center**  
 Email: [ap.support@nsc.com](mailto:ap.support@nsc.com)

**National Semiconductor Japan Technical Support Center**  
 Email: [jpn.feedback@nsc.com](mailto:jpn.feedback@nsc.com)