

ANSALDO**Ansaldo Trasporti s.p.a.
Unita' Semiconduttori**Via N. Lorenzi 8 - I 16152 GENOVA - ITALY
Tel. int. +39/(0)10 6556549 - (0)10 6556488
Fax Int. +39/(0)10 6442510
Tx 270318 ANSUSE I -**PHASE CONTROL THYRISTOR****AT655**

| | |
|--------------------------|---------------|
| Repetitive voltage up to | 2800 V |
| Mean on-state current | 1545 A |
| Surge current | 30 kA |

FINAL SPECIFICATION

feb 97 - ISSUE : 03

| Symbol | Characteristic | Conditions | T _j [°C] | Value | Unit |
|--|--|---|------------------------|-------------|------------------|
| BLOCKING | | | | | |
| V _{RRM} | Repetitive peak reverse voltage | | 125 | 2800 | V |
| V _{RSM} | Non-repetitive peak reverse voltage | | 125 | 2900 | V |
| V _{DRM} | Repetitive peak off-state voltage | | 125 | 2800 | V |
| I _{RRM} | Repetitive peak reverse current | V=V _{RRM} | 125 | 70 | mA |
| I _{DRM} | Repetitive peak off-state current | V=V _{DRM} | 125 | 70 | mA |
| CONDUCTING | | | | | |
| I _{T(AV)} | Mean on-state current | 180° sin, 50 Hz, Th=55°C, double side cooled | | 1545 | A |
| I _{T(AV)} | Mean on-state current | 180° sin, 50 Hz, Tc=85°C, double side cooled | | 1330 | A |
| I _{TSM} | Surge on-state current | sine wave, 10 ms | 125 | 30 | kA |
| I ² t | I ² t | without reverse voltage | | 4500 x1E3 | A ² s |
| V _T | On-state voltage | On-state current = 2900 A | 25 | 1.8 | V |
| V _{T(TO)} | Threshold voltage | | 125 | 1.05 | V |
| r _T | On-state slope resistance | | 125 | 0.290 | mohm |
| SWITCHING | | | | | |
| di/dt | Critical rate of rise of on-state current, min. | From 75% V _{DRM} up to 1730 A, gate 10V 5ohm | 125 | 200 | A/μs |
| dv/dt | Critical rate of rise of off-state voltage, min. | Linear ramp up to 70% of V _{DRM} | 125 | 500 | V/μs |
| t _d | Gate controlled delay time, typical | V _D =100V, gate source 10V, 10 ohm, tr=.5 μs | 25 | 3 | μs |
| t _q | Circuit commutated turn-off time, typical | dV/dt = 20 V/μs linear up to 75% V _{DRM} | | 320 | μs |
| Q _{rr} | Reverse recovery charge | di/dt=-20 A/μs, I= 1140 A | 125 | | μC |
| I _{rr} | Peak reverse recovery current | VR= 50 V | | | A |
| I _H | Holding current, typical | V _D =5V, gate open circuit | 25 | 300 | mA |
| I _L | Latching current, typical | V _D =5V, tp=30μs | 25 | 700 | mA |
| GATE | | | | | |
| V _{GT} | Gate trigger voltage | V _D =5V | 25 | 3.5 | V |
| I _{GT} | Gate trigger current | V _D =5V | 25 | 300 | mA |
| V _{GD} | Non-trigger gate voltage, min. | V _D =V _{DRM} | 125 | 0.25 | V |
| V _{FGM} | Peak gate voltage (forward) | | | 30 | V |
| I _{FGM} | Peak gate current | | | 10 | A |
| V _{RGM} | Peak gate voltage (reverse) | | | 5 | V |
| P _{GM} | Peak gate power dissipation | Pulse width 100 μs | | 150 | W |
| P _G | Average gate power dissipation | | | 2 | W |
| MOUNTING | | | | | |
| R _{th(j-h)} | Thermal impedance, DC | Junction to heatsink, double side cooled | | 21 | °C/kW |
| R _{th(c-h)} | Thermal impedance | Case to heatsink, double side cooled | | 6 | °C/kW |
| T _j | Operating junction temperature | | | -30 / 125 | °C |
| F | Mounting force | | | 22.0 / 24.5 | kN |
| | Mass | | | 520 | g |
| ORDERING INFORMATION : AT655 S 28 | | | | | |
| standard specification <input type="checkbox"/> VDRM&VRRM/100 <input type="checkbox"/> | | | | | |

DISSIPATION CHARACTERISTICS

SQUARE WAVE

Th [°C]

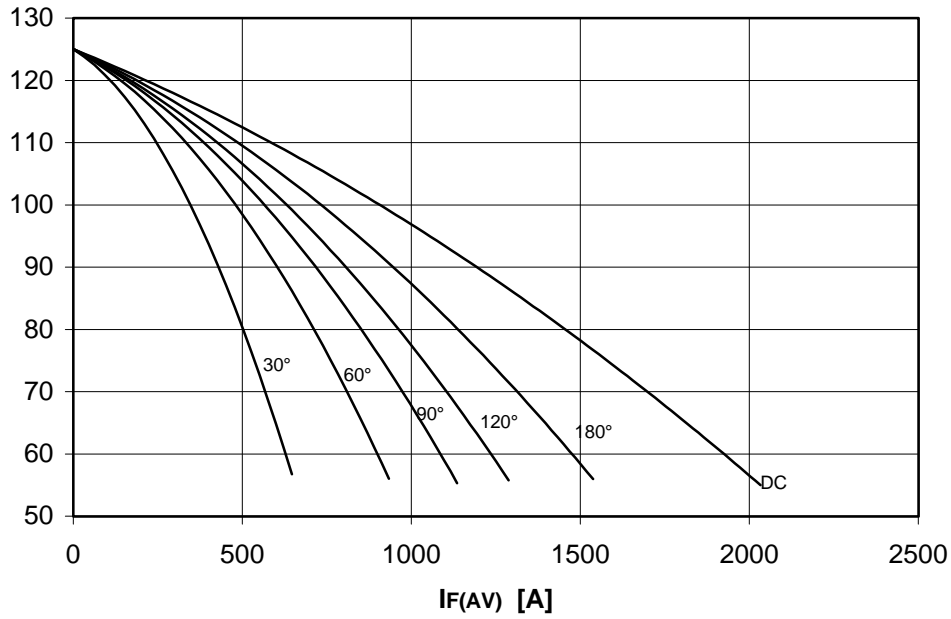

PF(AV) [W]

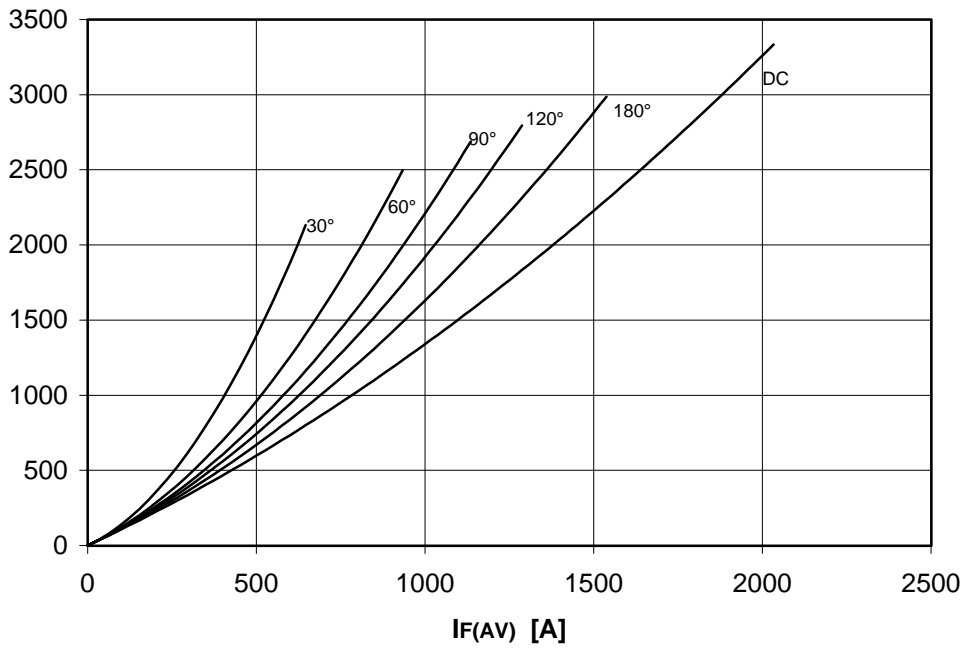

DISSIPATION CHARACTERISTICS

SINE WAVE

Th [°C]

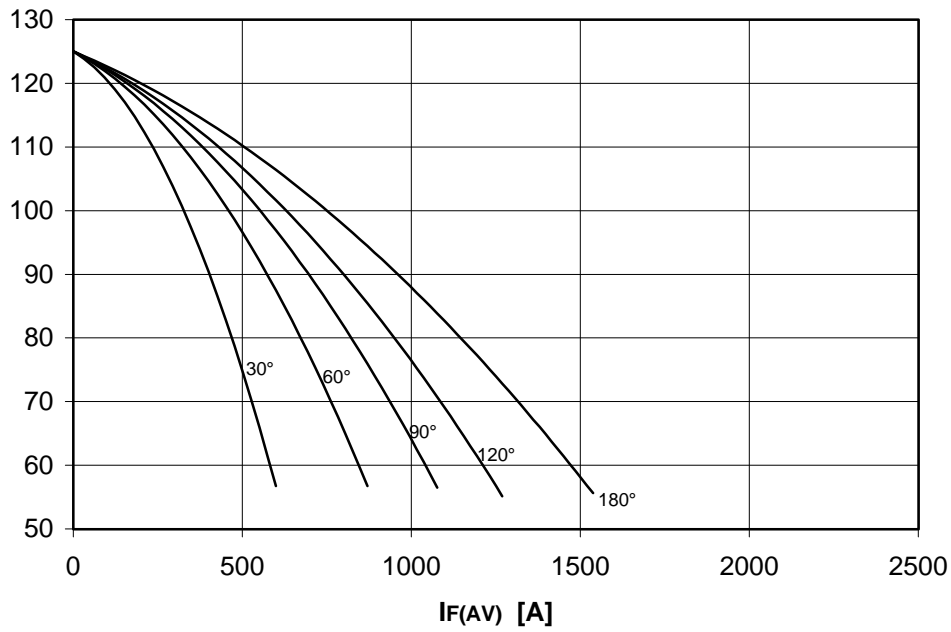

PF(AV) [W]

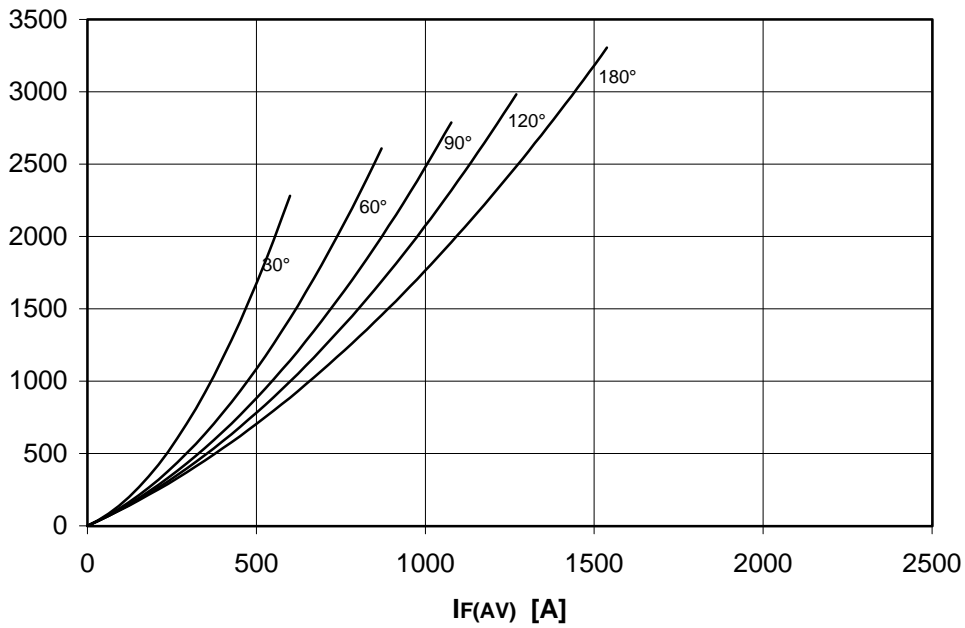

AT655 PHASE CONTROL THYRISTOR



FINAL SPECIFICATION feb 97 - ISSUE : 03

ON-STATE CHARACTERISTIC
T_j = 125 °C

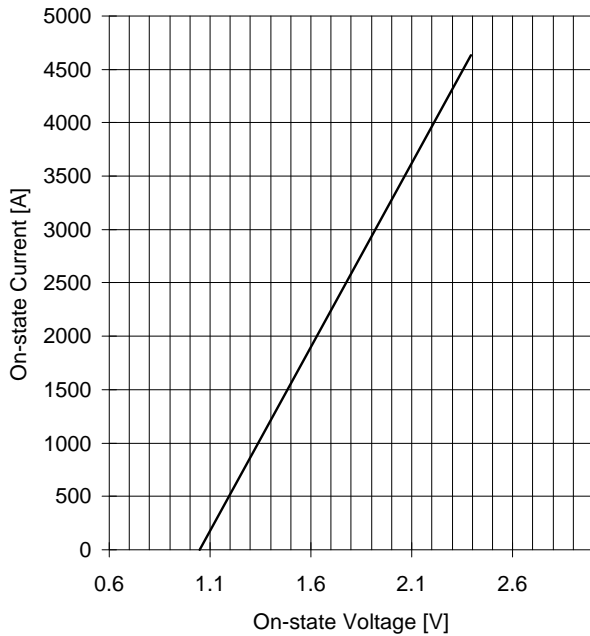

SURGE CHARACTERISTIC
T_j = 125 °C

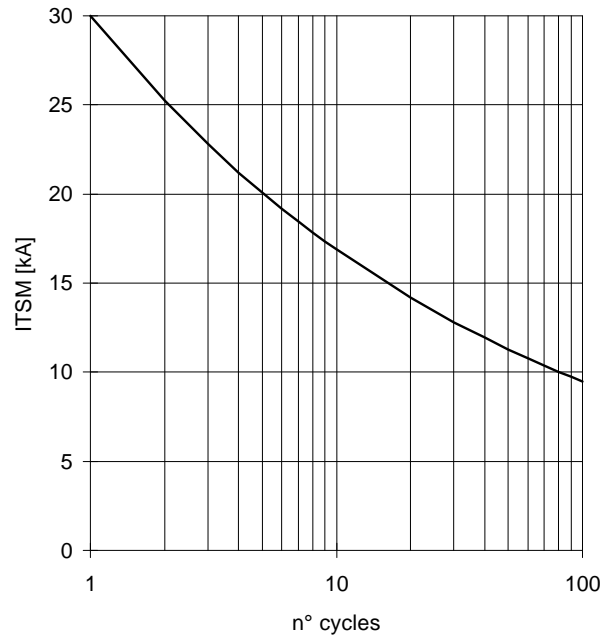

TRANSIENT THERMAL IMPEDANCE
DOUBLE SIDE COOLED

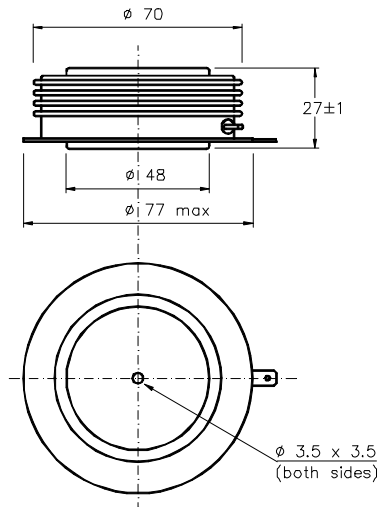
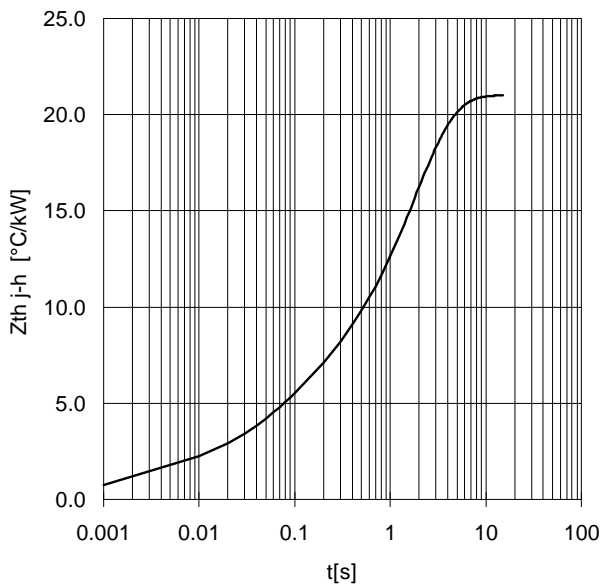

Dimensions in mm



Cathode terminal type DIN 46244 - A 4.8 - 0.8

Gate terminal type AMP 60598 - 1

All the characteristics given in this data sheet are guaranteed only with uniform clamping force, cleaned and lubricated heatsink, surfaces with flatness < .03 mm and roughness < 2 μm.

In the interest of product improvement ANSALDO reserves the right to change any data given in this data sheet at any time without previous notice.

If not stated otherwise the maximum value of ratings (symbols over shaded background) and characteristics is reported.

Distributed by

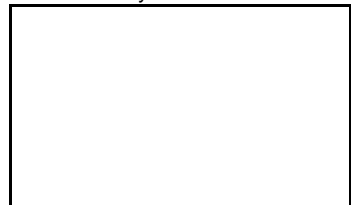



LittleDiode supplies new, hard to find or obsolete electronic components and semiconductors all over the world.

With over two million different components listed you are sure to find the part you need.

Feel free to visit us today at our online store:

LittleDiode.com

Looking forward to providing you with the best possible service.