

## 74VHCT540A

### Octal Buffer/Line Driver with 3-STATE Outputs

#### General Description

The VHCT540A is an advanced high-speed CMOS device fabricated with silicon gate CMOS technology. It achieves the high-speed operation similar to equivalent Bipolar Schottky TTL while maintaining the CMOS low power dissipation.

The VHCT540A is an octal buffer/line driver designed to be employed as memory and address drivers, clock drivers and bus oriented transmitter/receivers.

This device is similar in function to the VHCT240A while providing flow-through architecture (inputs on opposite side from outputs). This pinout arrangement makes this device especially useful as an output port for microprocessors, allowing ease of layout and greater PC board density.

Protection circuits ensure that 0V to 7V can be applied to the input and output (Note 1) pins without regard to the supply voltage. This device can be used to interface 3V to 5V systems and two supply systems such as battery backup. This circuit prevents device destruction due to mismatched supply and input voltages.

**Note 1:** Outputs in OFF-STATE

#### Features

- High Speed:  $t_{PD} = 5.4$  ns (typ) at  $V_{CC} = 5$  V
- Low Power Dissipation:  $I_{CC} = 4$   $\mu$ A (max) at  $T_A = 25^\circ$ C
- Power down protection is provided on all inputs and outputs
- Pin and function compatible with 74HCT540

#### Ordering Code:

Order Number	Package Number	Package Dissipation
74VHCT540AM	M20B	20-Lead Small Outline Integrated Circuit (SOIC), JEDEC MS-013, 0.300 Wide
74VHCT540ASJ	M20D	20-Lead Small Outline Package (SOP), EIAJ TYPE II, 5.3mm Wide
74VHCT540AMTC	MTC20	20-Lead Thin Shrink Small Outline Package (TSSOP), JEDEC MO-153, 4.4mm Wide
74VHCT540AN	N20A	20-Lead Plastic Dual-In-Line Package (PDIP), JEDEC MS-001, 0.300 Wide

Surface mount packages are also available on Tape and Reel. Specify by appending the suffix letter "X" to the ordering code.

#### Logic Symbol

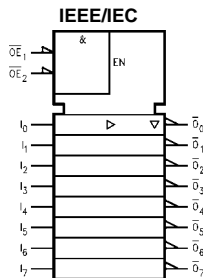

#### Connection Diagram

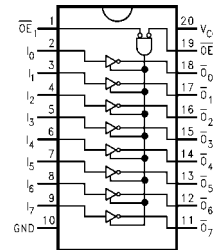

#### Pin Descriptions

Pin Names	Description
$\overline{OE}_1, \overline{OE}_2$	3-STATE Output Enable Inputs
$I_0 - I_7$	Inputs
$\overline{O}_0 - \overline{O}_7$	3-STATE Outputs

#### Truth Table

Inputs			Outputs
$\overline{OE}_1$	$\overline{OE}_2$	I	
L	L	H	L
H	X	X	Z
X	H	X	Z
L	L	L	H

H = HIGH Voltage Level  
L = LOW Voltage Level  
X = Immaterial  
Z = High Impedance

**Absolute Maximum Ratings** (Note 2)

Supply Voltage ( $V_{CC}$ )	-0.5V to +7.0V
DC Input Voltage ( $V_{IN}$ )	-0.5V to +7.0V
DC Output Voltage ( $V_{OUT}$ )	
(Note 3)	-0.5V to +7.0V
(Note 4)	-0.5V to $V_{CC} + 0.5V$
Input Diode Current ( $I_{IK}$ )	-20 mA
Output Diode Current ( $I_{OK}$ )	
(Note 5)	$\pm 20$ mA
DC Output Current ( $I_{OUT}$ )	$\pm 25$ mA
DC $V_{CC}/GND$ Current ( $I_{CC}$ )	$\pm 75$ mA
Storage Temperature ( $T_{STG}$ )	-65°C to +150°C
Lead Temperature ( $T_L$ )	
(Soldering, 10 seconds)	260°C

**Recommended Operating Conditions** (Note 6)

Supply Voltage ( $V_{CC}$ )	4.5V to +5.5V
Input Voltage ( $V_{IN}$ )	0V to +5.5V
Output Voltage ( $V_{OUT}$ )	
(Note 4)	0V to $V_{CC}$
(Note 3)	0V to 5.5V
Operating Temperature ( $T_{OPR}$ )	-40°C to +85°C
Input Rise and Fall Time ( $t_r, t_f$ )	
$V_{CC} = 5.0V \pm 0.5V$	0 = 20 ns/V

**Note 2:** Absolute Maximum Ratings are values beyond which the device may be damaged or have its useful life impaired. The databook specifications should be met, without exception, to ensure that the system design is reliable over its power supply, temperature, and output/input loading variables. Fairchild does not recommend operation outside databook specifications.

**Note 3:** When outputs are in OFF-STATE or when  $V_{CC} = 0V$ .

**Note 4:** HIGH or LOW state.  $I_{OUT}$  absolute maximum rating must be observed.

**Note 5:**  $V_{OUT} < GND$ ,  $V_{OUT} > V_{CC}$  (outputs active).

**Note 6:** Unused inputs must be held HIGH or LOW. They may not float.

**DC Electrical Characteristics**

Symbol	Parameter	$V_{CC}$ (V)	$T_A = 25^\circ C$			$T_A = -40^\circ C$ to $+85^\circ C$		Units	Conditions
			Min	Typ	Max	Min	Max		
$V_{IH}$	HIGH Level Input Voltage	4.5 – 5.5	2.0			2.0		V	
$V_{IL}$	LOW Level Input Voltage	4.5 – 5.5			0.8		0.8	V	
$V_{OH}$	HIGH Level	4.5	4.4	4.5		4.4		V	$V_{IN} = V_{IH}$ $I_{OH} = -50 \mu A$
	Output Voltage	4.5	3.94			3.80		V	or $V_{IL}$ $I_{OH} = -8 mA$
$V_{OL}$	LOW Level	4.5		0.0	0.1		0.1	V	$V_{IN} = V_{IH}$ $I_{OL} = 50 \mu A$
	Output Voltage	4.5			0.36		0.44	V	or $V_{IL}$ $I_{OL} = 8 mA$
$I_{OZ}$	3-STATE Output OFF-STATE Current	5.5			$\pm 0.25$		$\pm 2.5$	$\mu A$	$V_{IN} = V_{IH}$ or $V_{IL}$ $V_{OUT} = V_{CC}$ or GND
$I_{IN}$	Input Leakage Current	0 – 5.5			$\pm 0.1$		$\pm 1.0$	$\mu A$	$V_{IN} = 5.5V$ or GND
$I_{CC}$	Quiescent Supply Current	5.5			4.0		40.0	$\mu A$	$V_{IN} = V_{CC}$ or GND
$I_{CCT}$	Maximum $I_{CC}/input$	5.5			1.35		1.50	mA	$V_{IN} = 3.4V$ other inputs = $V_{CC}$ or GND
$I_{OFF}$	Output Leakage Current	0			0.5		5.0	$\mu A$	$V_{OUT} = 5.5V$

**Noise Characteristics**

Symbol	Parameter	$V_{CC}$ (V)	$T_A = 25^\circ C$		Units	Conditions
			Typ	Limits		
$V_{OLP}$ (Note 7)	Quiet Output Maximum Dynamic $V_{OL}$	5.0	1.2	1.6	V	$C_L = 50 pF$
$V_{OLV}$ (Note 7)	Quiet Output Minimum Dynamic $V_{OL}$	5.0	-1.2	1.6	V	$C_L = 50 pF$
$V_{IHD}$ (Note 7)	Minimum HIGH Level Dynamic Input Voltage	5.0		2.0	V	$C_L = 50 pF$
$V_{ILD}$ (Note 7)	Maximum HIGH Level Dynamic Input Voltage	5.0		0.8	V	$C_L = 50 pF$

**Note 7:** Parameter guaranteed by design.

AC Electrical Characteristics									
Symbol	Parameter	V <sub>CC</sub> (V)	T <sub>A</sub> = 25°C			T <sub>A</sub> = -40°C to +85°C		Units	Conditions
			Min	Typ	Max	Min	Max		
t <sub>PLH</sub>	Propagation Delay Time	5.0 ± 0.5	5.4	7.4	1.0	8.5	ns	C <sub>L</sub> = 15 pF	
t <sub>PHL</sub>			5.9	8.4	1.0	9.5		C <sub>L</sub> = 50 pF	
t <sub>PZL</sub>	3-STATE Output	5.0 ± 0.5	8.3	11.3	1.0	13.0	ns	R <sub>L</sub> = 1 kΩ C <sub>L</sub> = 15 pF	
t <sub>PZH</sub>	Enable Time		8.8	12.3	1.0	14.0		C <sub>L</sub> = 50 pF	
t <sub>PLZ</sub>	3-STATE Output	5.0 ± 0.5	9.4	11.9	1.0	13.5	ns	R <sub>L</sub> = 1 kΩ C <sub>L</sub> = 50 pF	
t <sub>PHZ</sub>	Disable Time								
t <sub>OSLH</sub>	Output to Output	5.0 ± 0.5	1.0		1.0		ns	(Note 8) C <sub>L</sub> = 50 pF	
t <sub>OSHL</sub>	Skew								
C <sub>IN</sub>	Input Capacitance		4	10	10		pF	V <sub>CC</sub> = Open	
C <sub>OUT</sub>	Output Capacitance		9				pF	V <sub>CC</sub> = 5.0V	
C <sub>PD</sub>	Power Dissipation Capacitance		19				pF	(Note 9)	

**Note 8:** Parameter guaranteed by design.  $t_{OSLH} = |t_{PLHmax} - t_{PLHmin}|$ ;  $t_{OSHL} = |t_{PHLmax} - t_{PHLmin}|$ .

**Note 9:** C<sub>PD</sub> is defined as the value of the internal equivalent capacitance which is calculated from the operating current consumption without load. Average operating current can be obtained by the equation:  $I_{CC} (opr.) = C_{PD} * V_{CC} * f_{IN} + I_{CC}/8$  (per bit).

**Physical Dimensions** inches (millimeters) unless otherwise noted

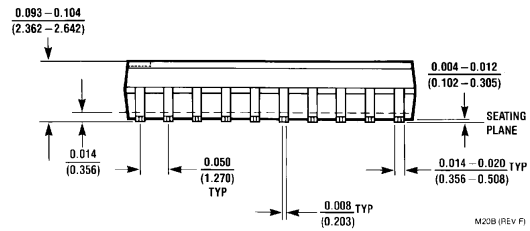
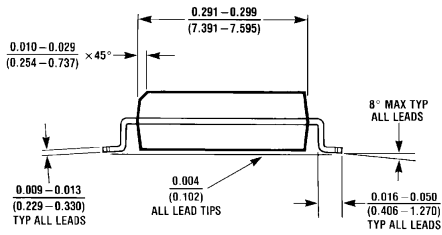
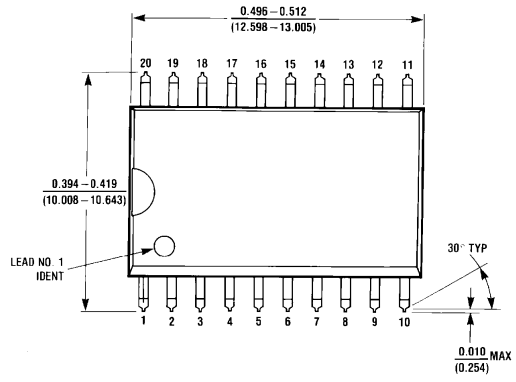

**20-Lead Small Outline Integrated Circuit (SOIC), JEDEC MS-013, 0.300 Wide  
Package Number M20B**

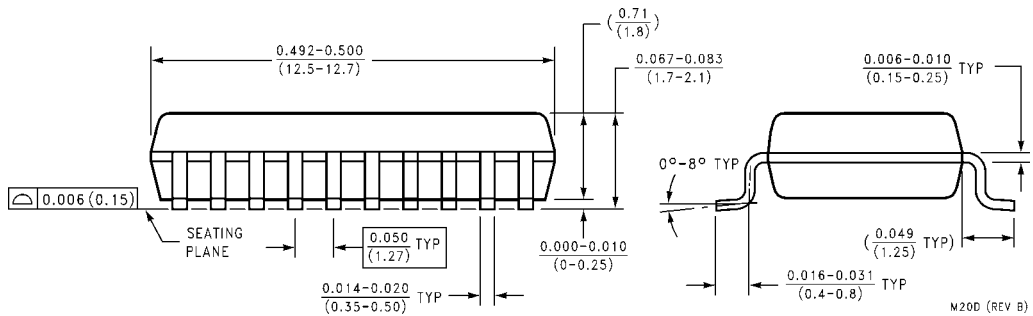
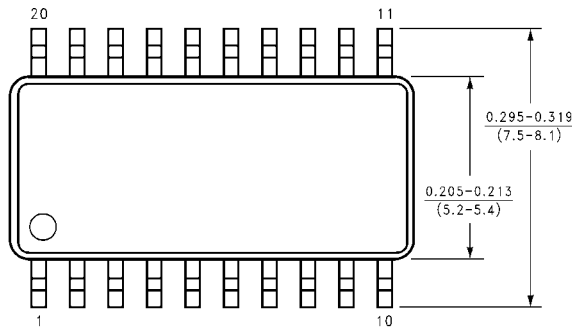

**20-Lead Small Outline Package (SOP), EIAJ TYPE II, 5.3mm Wide  
Package Number M20D**

**Physical Dimensions** inches (millimeters) unless otherwise noted (Continued)

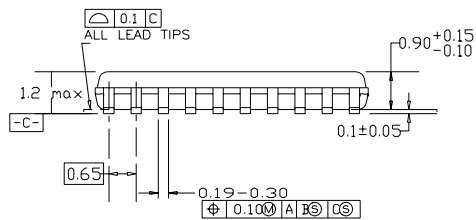
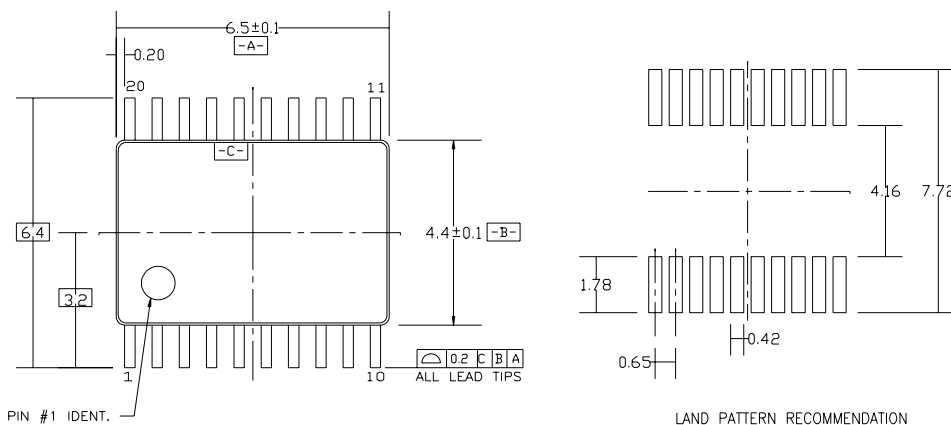

DIMENSIONS ARE IN MILLIMETERS

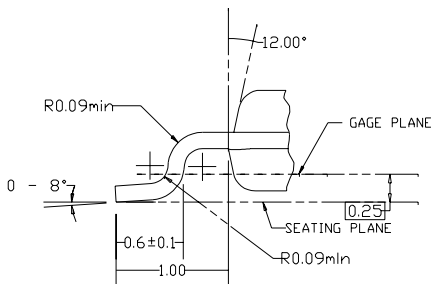
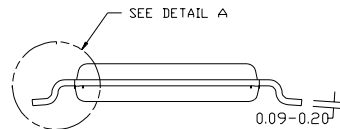

DETAIL A

NOTES:

- A. CONFORMS TO JEDEC REGISTRATION MO-153, VARIATION AC, REF NOTE 6, DATE 7/93.
- B. DIMENSIONS ARE IN MILLIMETERS.
- C. DIMENSIONS ARE EXCLUSIVE OF BURRS, MOLDS FLASH, AND TIE BAR EXTRUSIONS.
- D. DIMENSIONS AND TOLERANCES PER ANSI Y14.5M, 1982.

**20-Lead Thin Shrink Small Outline Package (TSSOP), JEDEC MO-153, 4.4mm Wide  
Package Number MTC20**

**Physical Dimensions** inches (millimeters) unless otherwise noted (Continued)

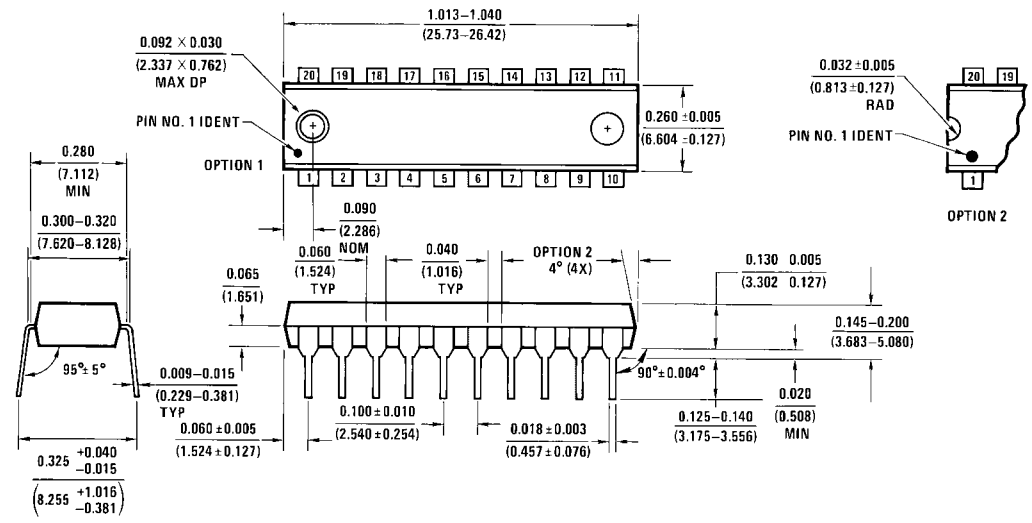

20-Lead Plastic Dual-In-Line Package (PDIP), JEDEC MS-001, 0.300 Wide Package Number N20A

**LIFE SUPPORT POLICY**

FAIRCHILD'S PRODUCTS ARE NOT AUTHORIZED FOR USE AS CRITICAL COMPONENTS IN LIFE SUPPORT DEVICES OR SYSTEMS WITHOUT THE EXPRESS WRITTEN APPROVAL OF THE PRESIDENT OF FAIRCHILD SEMICONDUCTOR CORPORATION. As used herein:

1. Life support devices or systems are devices or systems which, (a) are intended for surgical implant into the body, or (b) support or sustain life, and (c) whose failure to perform when properly used in accordance with instructions for use provided in the labeling, can be reasonably expected to result in a significant injury to the user.
2. A critical component in any component of a life support device or system whose failure to perform can be reasonably expected to cause the failure of the life support device or system, or to affect its safety or effectiveness.

[www.fairchildsemi.com](http://www.fairchildsemi.com)



LittleDiode supplies new, hard to find or obsolete electronic components and semiconductors all over the world.

With over two million different components listed you are sure to find the part you need.

Feel free to visit us today at our online store:

[LittleDiode.com](http://LittleDiode.com)

Looking forward to providing you with the best possible service.