

**MINIATURE SIGNAL RELAY  
EA2 SERIES****COMPACT AND LIGHTWEIGHT****DESCRIPTION**

The EA2 series has reduced package size and power consumption to other NEC Conventional relays. Furthermore, it complies with 1500 V surge-voltage requirement of FCC part 68 by the unique structure and the efficient magnetic circuit

**FEATURES**

- Low power consumption
- Compact and light weight
- 2 form c contact arrangement
- Low magnetic arrangement
- Breakdown voltage : 1000 Vac (surge voltage 1500 V), FCC Part 68 compliant
- Tube packaging
- UL recognized (E73266), CAS certified (LR46266)

**APPLICATIONS**

Electronic switching systems, PBX, key telephone systems, automatic test equipment and other electronic equipment.

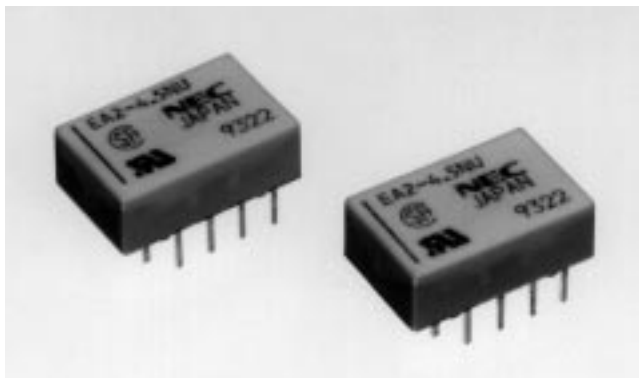
**ATTENTION****DO NOT EXCEED MAXIMUM RATINGS.**

Do not use relays under exceeding conditions such as over ambient temperature, over voltage and over current. Incorrect use could result in abnormal heating, damage to related parts or cause burning.

**READ CAUTIONS IN THE SELECTION GUIDE.**

Read the cautions described in NEC's "Miniature Relays" (ER0046EJ\*) when you choose relays for your application.

OUTLINE DRAWING AND DIMENSIONS

PAD LAYOUT (bottom view)

Unit : mm (inch)

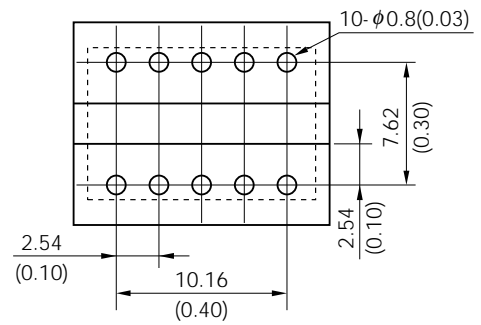
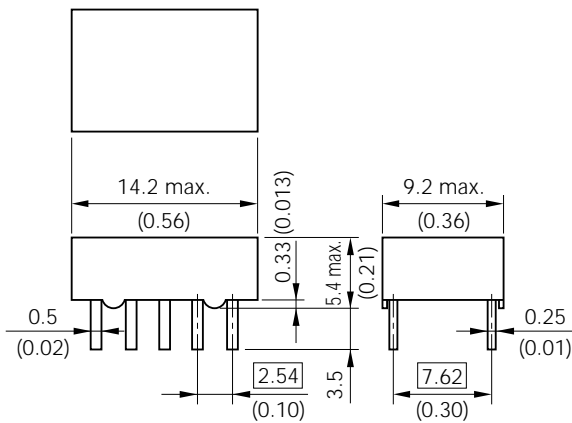

Note. Tolerance ±0.1 (±0.004) unless otherwise specified

Note. tolerance ±0.2 (±0.008) unless otherwise specified  
 Dimensions in    show basic size.  
 NJ type : Cover height-6.3 mm (0.248), Leads-2.8 mm (0.11)

MARKINGS

SAFETY STANDARD AND RATING

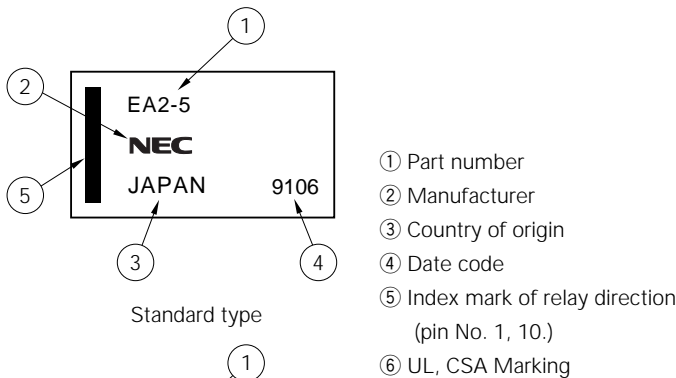

UL Recognized (UL508)* File No E73266	CSA Certificated (CSA C22.2 No 14) File No LR46266
30 Vdc, 1 A (Resistive)	
110 Vdc, 0.3 A (Resistive)	
125 Vdc, 0.5 A (Resistive)	

\* Spacing : UL114, UL478

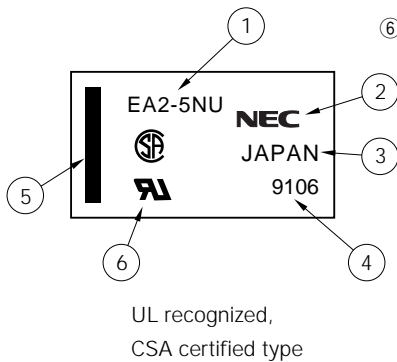

PIN CONFIGURATIONS

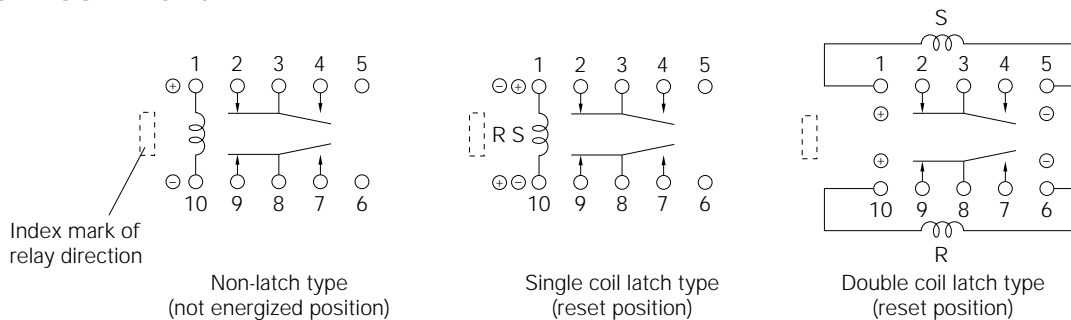

S : Coil polarity of set (operate)  
 R : Coil polarity of reset (release)

PART NUMBER SYSTEM

EA2 - 3 S NU

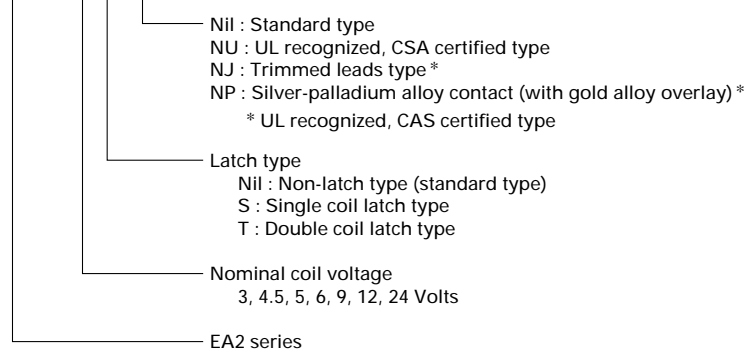

PERFORMANCE CHARACTERISTICS

Contact Form		2 form c	
Contact rating	Maximum switching power	30 W (resistive)	62.5 VA (resistive)
	Maximum switching voltage	220 Vdc	250 Vac
	Maximum switching current	1 A	
	Maximum carrying current	2 A	
	Minimum contact ratings	10 mVdc, 10 $\mu$ A *1	
Initial contact resistance		50 m $\Omega$ typ. (Initial)	
Contact material		Silver alloy with gold alloy overlay	
Nominal operating Power	Non-latch type and double coil latch type	140 mW (3 to 12 V) 200 mW (24 V)	
	Single coil Latch type	100 mW (3 to 12 V) 150 mW (24 V)	
Minimum operating Power	Non-latch type and double coil latch type	79 mW (3 to 12 V) 113 mW (24 V)	
	Single coil latch type	56 mW (3 to 12 V) 85 mW (24 V)	
Operate time (excluding bounce)		Approximately 2 ms without diode	
Release time (excluding bounce)		Approximately 1 ms without diode	
Insulation resistance		1000 M $\Omega$ at 500 Vdc	
Breakdown voltage	Between open contacts	1000 Vac (for one minute)	
	Between adjacent contacts	1500 V surge (10 $\times$ 160 $\mu$ s *2)	
	Between coil and contact		
Shock resistance		735 m / s <sup>2</sup> (75 G) (misoperating) 980 m / s <sup>2</sup> (100 G) (destructive failure)	
Vibration resistance		10 to 55 Hz at double amplitude of 3 mm (20 G) (misoperating) 10 to 55 Hz, at double amplitude of 5 mm (30 G) (destructive failure)	
Ambient temperature		-40°C to 85°C	
Coil temperature rise		18 degrees at nominal coil voltage	
Running specifications	No load	1 $\times$ 10 <sup>8</sup> operations (Non-latch type) *3	
		1 $\times$ 10 <sup>7</sup> operations (latch type)	
	Load	50 Vdc 0.1 A (resistive), 1 $\times$ 10 <sup>6</sup> operations at 85°C, 2 Hz	
		10 Vdc 10 mA (resistive), 1 $\times$ 10 <sup>6</sup> operations at 85°C, 2 Hz	
Weight		Approximately 1.5 grams	

\*1 This value is a reference value in the resistance load.

Minimum capacity changes depending on switching frequency and environment temperature and the load.

\*2 Rise time : 10  $\mu$ s, fall time : 160  $\mu$ s

\*3 This shows a number of operation where it can be running by which a fatal defect is not caused, and a number of operation by which a steady characteristic is maintained is 1  $\times$  10<sup>7</sup> times.

PRODUCT LINEUP

Non-latch Type

at 20°C

Nominal Coil Voltage (Vdc)	Coil Resistance ( $\Omega$ ) $\pm 10\%$	Must Operate Voltage (Vdc)	Must Release Voltage (Vdc)
3	64.3	2.25	0.3
4.5	145	3.38	0.45
5	178	3.75	0.5
6	257	4.5	0.6
9	579	6.75	0.9
12	1028	9	1.2
24	2880	18	2.4

Single-Coil Latch Type

at 20°C

Nominal Coil Voltage (Vdc)	Coil Resistance ( $\Omega$ ) $\pm 10\%$	Must Operate Voltage (Vdc)	Must Release Voltage (Vdc)
3	90	2.25	2.25
4.5	202.5	3.38	3.38
5	250	3.75	3.75
6	360	4.5	4.5
9	810	6.75	6.75
12	1440	9	9
24	3840	18	18

Double-Coil Latch Type \*\* (Can not be driven by reverse polarity for reverse operation.)

at 20°C

Nominal Coil Voltage (Vdc)	Coil Resistance ( $\Omega$ ) $\pm 10\%$		Must Operate Voltage (Vdc)	Must Release Voltage (Vdc)
3	S	64.3	2.25	-
	R	64.3	-	2.25
4.5	S	145	3.38	-
	R	145	-	3.38
5	S	178	3.75	-
	R	178	-	3.75
6	S	257	4.5	-
	R	257	-	4.5
9	S	579	6.75	-
	R	579	-	6.75
12	S	1028	9	-
	R	1028	-	9
24	S	2880	18	-
	R	2880	-	18

Note \* Test by pulse voltage

\*\* S : Set coil (pin No.1...⊕, pin No.5...⊖) R: Reset coil (pin No.10...⊕, pin No.6...⊖)

The latch type relays should be initialized at appointed position before using, and should be energized to specific polarity by a bone polarity to avoid wrong operation.

Any special coil requirement, please contact NEC for availability.

TYPICAL PERFORMANCE DATA

SWITCHING CAPACITY

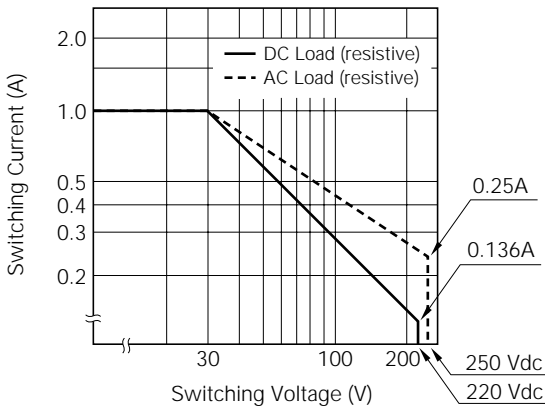

COIL TEMPERATURE RISE

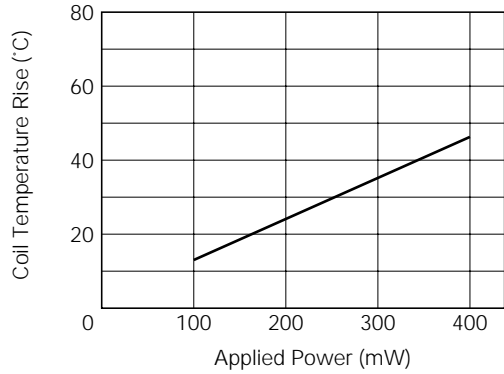

OPERATE TIME

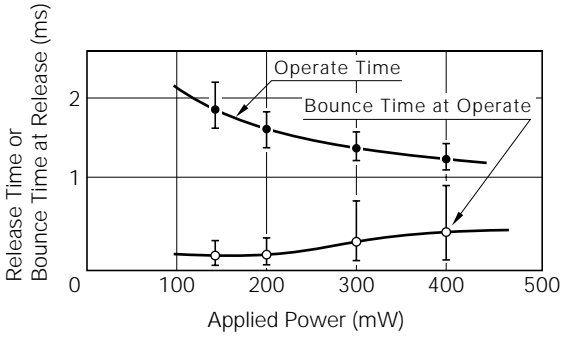

RELEASE TIME WITHOUT DIODE

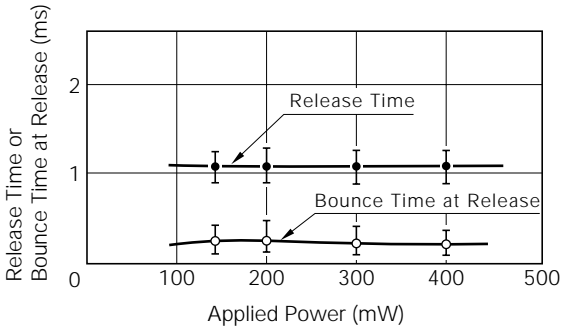

RELEASE TIME WITH DIODE

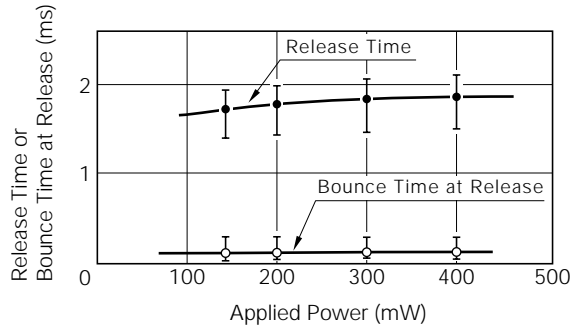

RUNNING SPECIFICATIONS (No load)

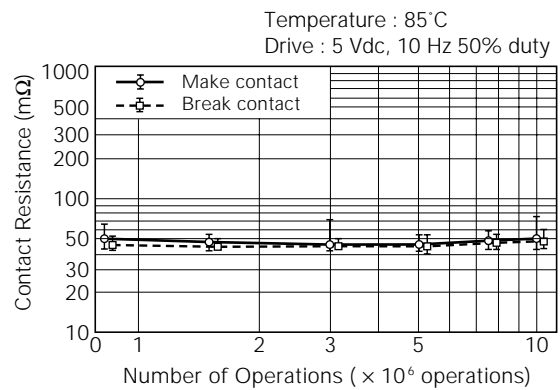
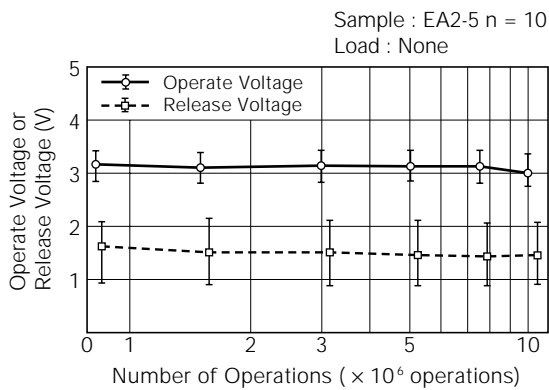

MAGNETIC INTERFERENCE

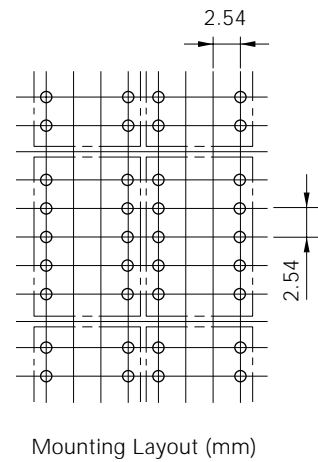
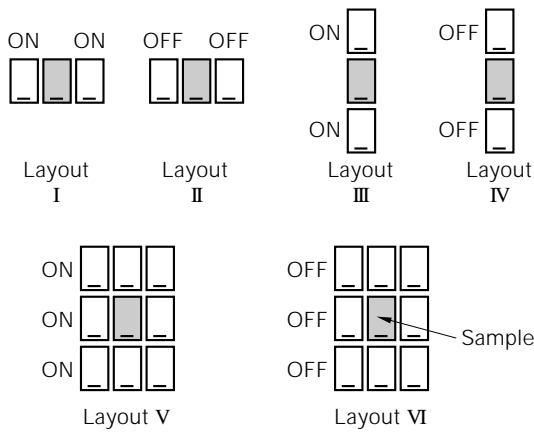
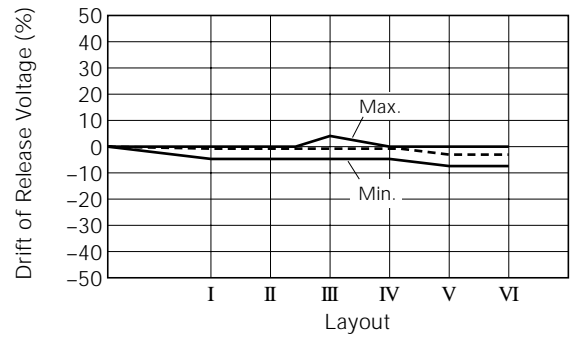
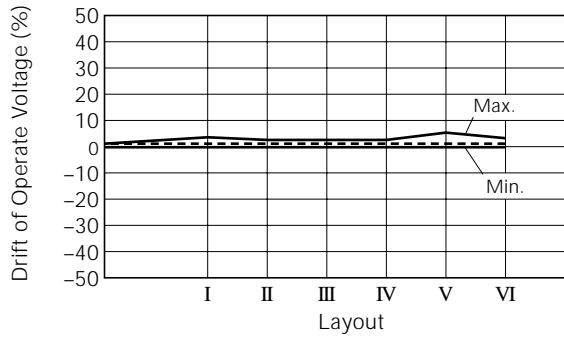

PACKAGE

Dimensions of Relay Tube (Unit : mm)

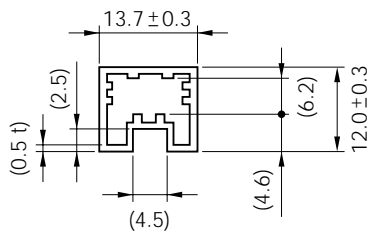

40 pieces / Tube  
Material : Polyvinyl chloride  
(anti-static treated)

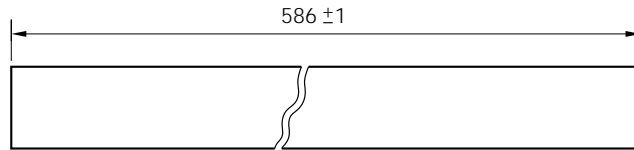

( ) Reference

Outline of Package

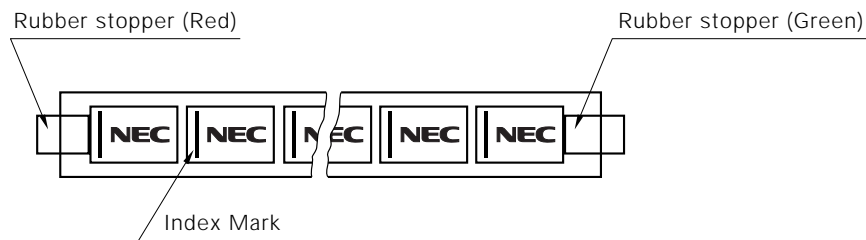

## GUIDE TO APPLICATIONS

1. When connecting coils, refer to the pin configuration to prevent misoperation or malfunction.
2. The latch type relay should be initialized at the appointed position (set or reset position) when using, and should be energized or deenergized to the specified polarity to avoid wrong operations by reversed contact state.
3. Soldering should be done at 250°C within 10 sec.
4. Ultrasonic cleaning is not recommended to keep reliable contact performance. Alcohol-based solvents are available as proper solvents.
5. Pressurized stress on the relay cover is not favorable to keep reliable operation of the relay during operation.
6. Minimum contact load of the relay is 10 mV, 10  $\mu$ A.  
This value is a reference value in the resistance load.  
Minimum capacity changes depending on switching frequency and environment temperature and the load.

No part of this document may be copied or reproduced in any form or by any means without the prior written consent of NEC Corporation. NEC Corporation assumes no responsibility for any errors which may appear in this document.

NEC Corporation does not assume any liability for infringement of patents, copyrights or other intellectual property rights of third parties by or arising from use of a device described herein or any other liability arising from use of such device. No license, either express, implied or otherwise, is granted under any patents, copyrights or other intellectual property rights of NEC Corporation or others.

While NEC Corporation has been making continuous effort to enhance the reliability of its electronic components, the possibility of defects cannot be eliminated entirely. To minimize risks of damage or injury to persons or property arising from a defect in an NEC electronic component, customers must incorporate sufficient safety measures in its design, such as redundancy, fire-containment, and anti-failure features.

NEC devices are classified into the following three quality grades:

"Standard", "Special", and "Specific". The Specific quality grade applies only to devices developed based on a customer designated "quality assurance program" for a specific application. The recommended applications of a device depend on its quality grade, as indicated below. Customers must check the quality grade of each device before using it in a particular application.

Standard: Computers, office equipment, communications equipment, test and measurement equipment, audio and visual equipment, home electronic appliances, machine tools, personal electronic equipment and industrial robots

Special: Transportation equipment (automobiles, trains, ships, etc.), traffic control systems, anti-disaster systems, anti-crime systems, safety equipment and medical equipment (not specifically designed for life support)

Specific: Aircrafts, aerospace equipment, submersible repeaters, nuclear reactor control systems, life support systems or medical equipment for life support, etc.

The quality grade of NEC devices is "Standard" unless otherwise specified in NEC's Data Sheets or Data Books. If customers intend to use NEC devices for applications other than those specified for Standard quality grade, they should contact an NEC sales representative in advance.

Anti-radioactive design is not implemented in this product.



LittleDiode supplies new, hard to find or obsolete electronic components and semiconductors all over the world.

With over two million different components listed you are sure to find the part you need.

Feel free to visit us today at our online store:

[LittleDiode.com](http://LittleDiode.com)

Looking forward to providing you with the best possible service.