

**Rectifier diodes
ultrafast, rugged**

BYV32E, BYV32EB series

FEATURES

- Low forward volt drop
- Fast switching
- Soft recovery characteristic
- Reverse surge capability
- High thermal cycling performance
- Low thermal resistance

SYMBOL

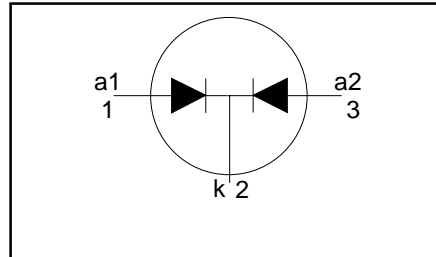

QUICK REFERENCE DATA

$V_R = 150\text{ V} / 200\text{ V}$
$V_F \leq 0.85\text{ V}$
$I_{O(AV)} = 20\text{ A}$
$I_{RRM} = 0.2\text{ A}$
$t_{tr} \leq 25\text{ ns}$

GENERAL DESCRIPTION

Dual, ultra-fast, epitaxial rectifier diodes intended for use as output rectifiers in high frequency switched mode power supplies.

The BYV32E series is supplied in the SOT78 conventional leaded package.
The BYV32EB series is supplied in the SOT404 surface mounting package.

PINNING

PIN	DESCRIPTION
1	anode 1 (a)
2	cathode (k) ¹
3	anode 2 (a)
tab	cathode (k)

SOT78 (TO220AB)

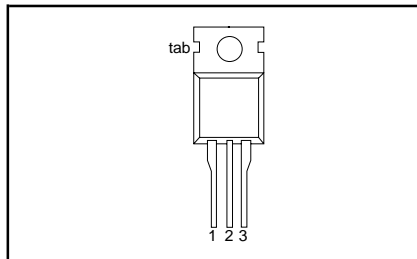

SOT404

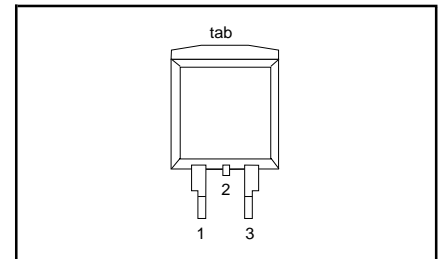

LIMITING VALUES

Limiting values in accordance with the Absolute Maximum System (IEC 134).

SYMBOL	PARAMETER	CONDITIONS	MIN.	MAX.		UNIT
				BYV32E / BYV32EB		
V_{RRM}	Peak repetitive reverse voltage		-	-150	-200	V
V_{RWM}	Crest working reverse voltage		-	150	200	V
V_R	Continuous reverse voltage		-	150	200	V
$I_{O(AV)}$	Average rectified output current (both diodes conducting)	square wave; $\delta = 0.5$; $T_{mb} \leq 115\text{ }^\circ\text{C}$	-	20		A
I_{FRM}	Repetitive peak forward current per diode	$t = 25\text{ }\mu\text{s}$; $\delta = 0.5$; $T_{mb} \leq 115\text{ }^\circ\text{C}$	-	20		A
I_{FSM}	Non-repetitive peak forward current per diode	$t = 10\text{ ms}$	-	125		A
		$t = 8.3\text{ ms}$	-	137		A
I_{RRM}	Repetitive peak reverse current per diode	sinusoidal; with reapplied $V_{RWM(max)}$ $t_p = 2\text{ }\mu\text{s}$; $\delta = 0.001$	-	0.2		A
I_{RSM}	Non-repetitive peak reverse current per diode	$t_p = 100\text{ }\mu\text{s}$	-	0.2		A
T_{stg}	Storage temperature		-40	150		$^\circ\text{C}$
T_j	Operating junction temperature		-	150		$^\circ\text{C}$

1 It is not possible to make connection to pin 2 of the SOT404 package

**Rectifier diodes
ultrafast, rugged**
BYV32E, BYV32EB series
ESD LIMITING VALUE

SYMBOL	PARAMETER	CONDITIONS	MIN.	MAX.	UNIT
V_C	Electrostatic discharge capacitor voltage	Human body model; $C = 250 \text{ pF}$; $R = 1.5 \text{ k}\Omega$	-	8	kV

THERMAL RESISTANCES

SYMBOL	PARAMETER	CONDITIONS	MIN.	TYP.	MAX.	UNIT
$R_{th \text{ j-mb}}$	Thermal resistance junction to mounting base	per diode	-	-	2.4	K/W
		both diodes	-	-	1.6	K/W
$R_{th \text{ j-a}}$	Thermal resistance junction to ambient	SOT78 package, in free air	-	60	-	K/W
		SOT404 and SOT428 packages, pcb mounted, minimum footprint, FR4 board	-	50	-	K/W

ELECTRICAL CHARACTERISTICS

 characteristics are per diode at $T_j = 25 \text{ }^\circ\text{C}$ unless otherwise stated

SYMBOL	PARAMETER	CONDITIONS	MIN.	TYP.	MAX.	UNIT
V_F	Forward voltage	$I_F = 8 \text{ A}$; $T_j = 150^\circ\text{C}$	-	0.72	0.85	V
		$I_F = 20 \text{ A}$	-	1.00	1.15	V
I_R	Reverse current	$V_R = V_{RWM}$; $T_j = 100^\circ\text{C}$	-	0.2	0.6	mA
		$V_R = V_{RWM}$	-	6	30	μA
Q_s	Reverse recovery charge	$I_F = 2 \text{ A}$; $V_R \geq 30 \text{ V}$; $-di_F/dt = 20 \text{ A}/\mu\text{s}$	-	8	12.5	nC
t_{rr1}	Reverse recovery time	$I_F = 1 \text{ A}$; $V_R \geq 30 \text{ V}$; $-di_F/dt = 100 \text{ A}/\mu\text{s}$	-	20	25	ns
t_{rr2}	Reverse recovery time	$I_F = 0.5 \text{ A}$ to $I_R = 1 \text{ A}$; $I_{rec} = 0.25 \text{ A}$	-	10	20	ns
V_{fr}	Forward recovery voltage	$I_F = 1 \text{ A}$; $di_F/dt = 10 \text{ A}/\mu\text{s}$	-	1	-	V

Rectifier diodes
ultrafast, rugged

BYV32E, BYV32EB series

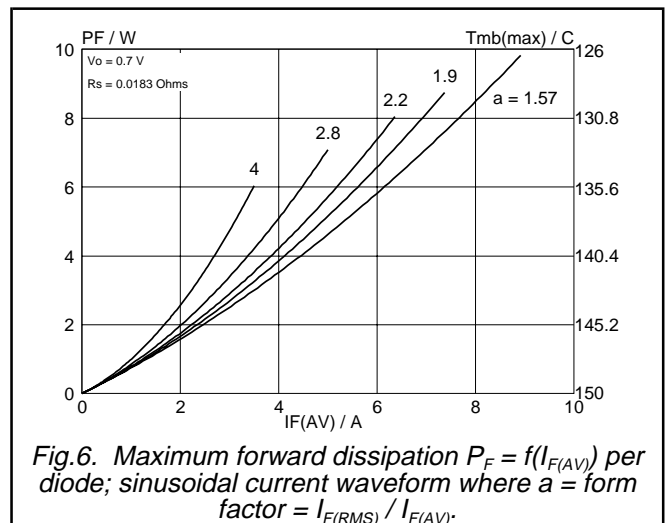
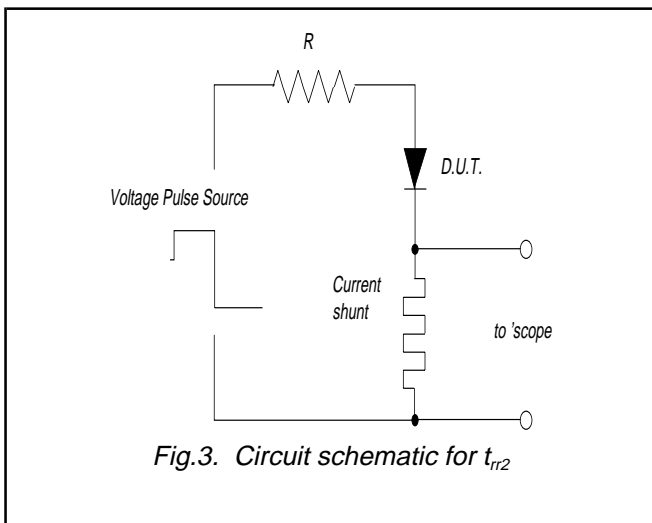
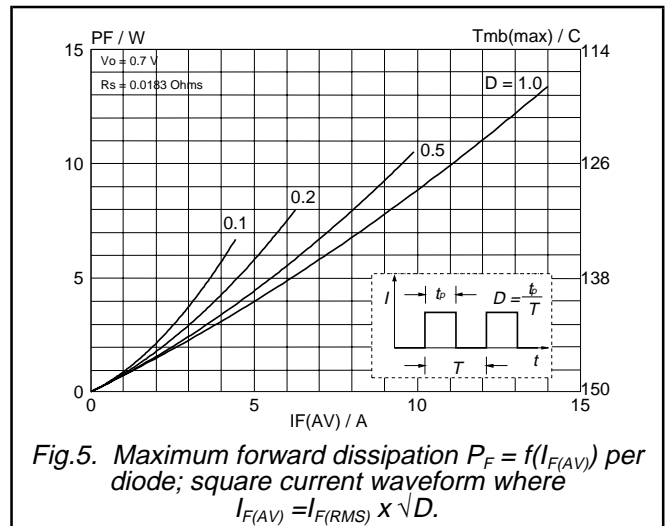
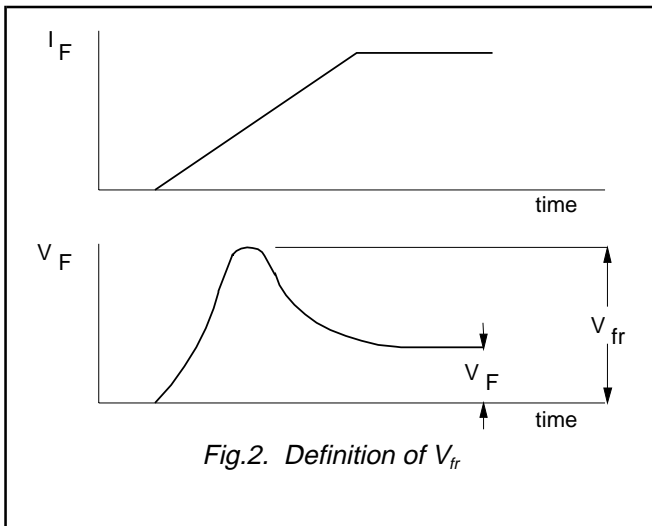
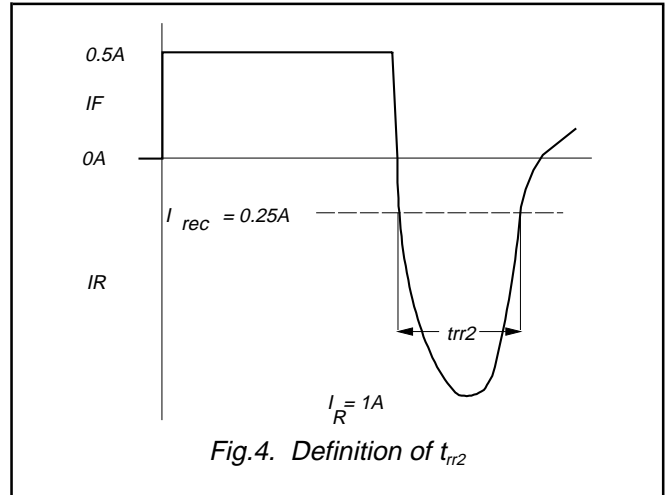
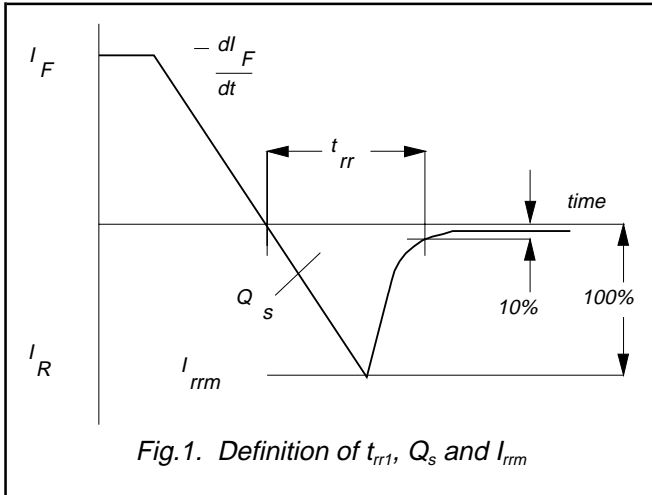

Rectifier diodes
ultrafast, rugged

BYV32E, BYV32EB series

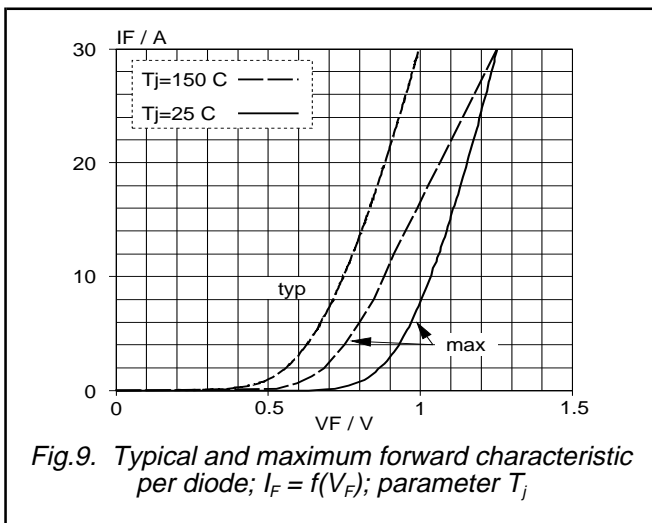
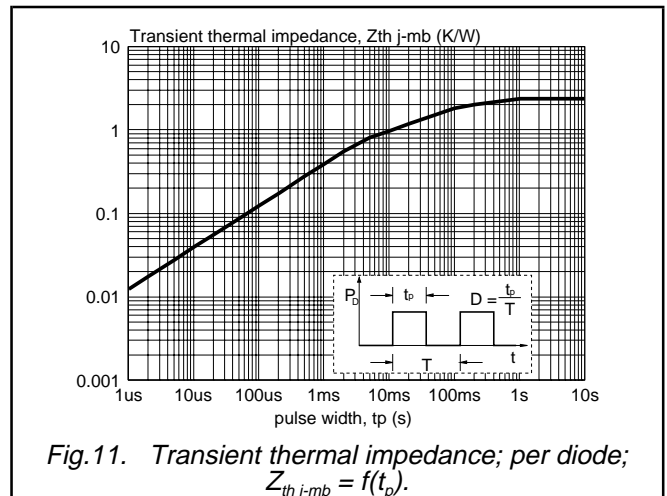
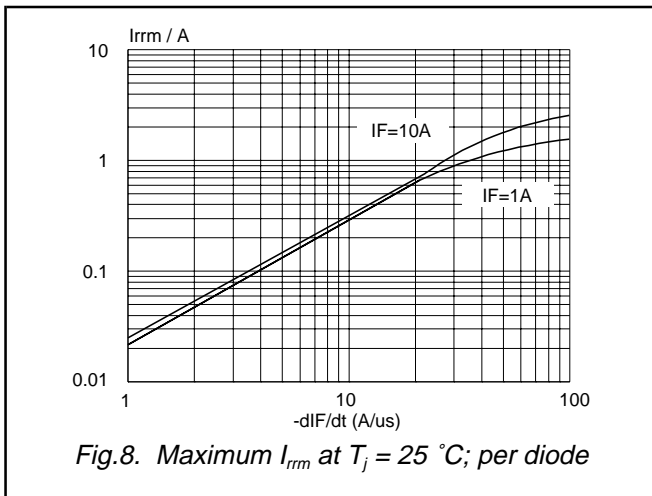
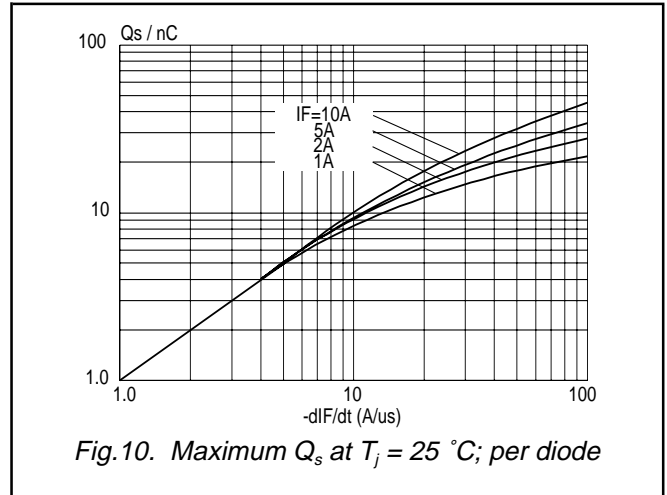
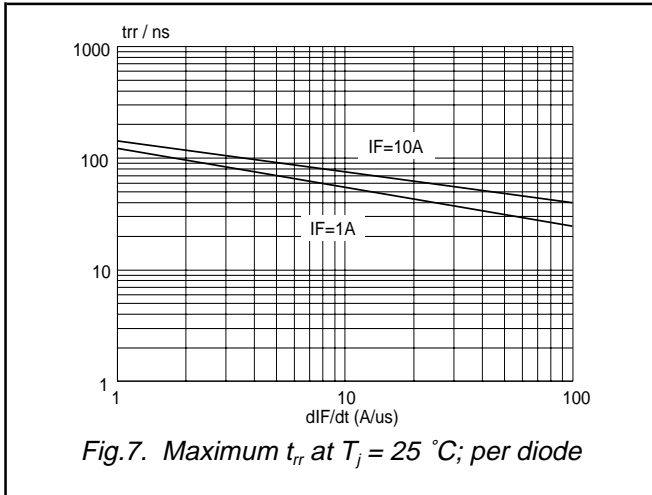

Rectifier diodes
ultrafast, rugged

BYV32E, BYV32EB series

MECHANICAL DATA

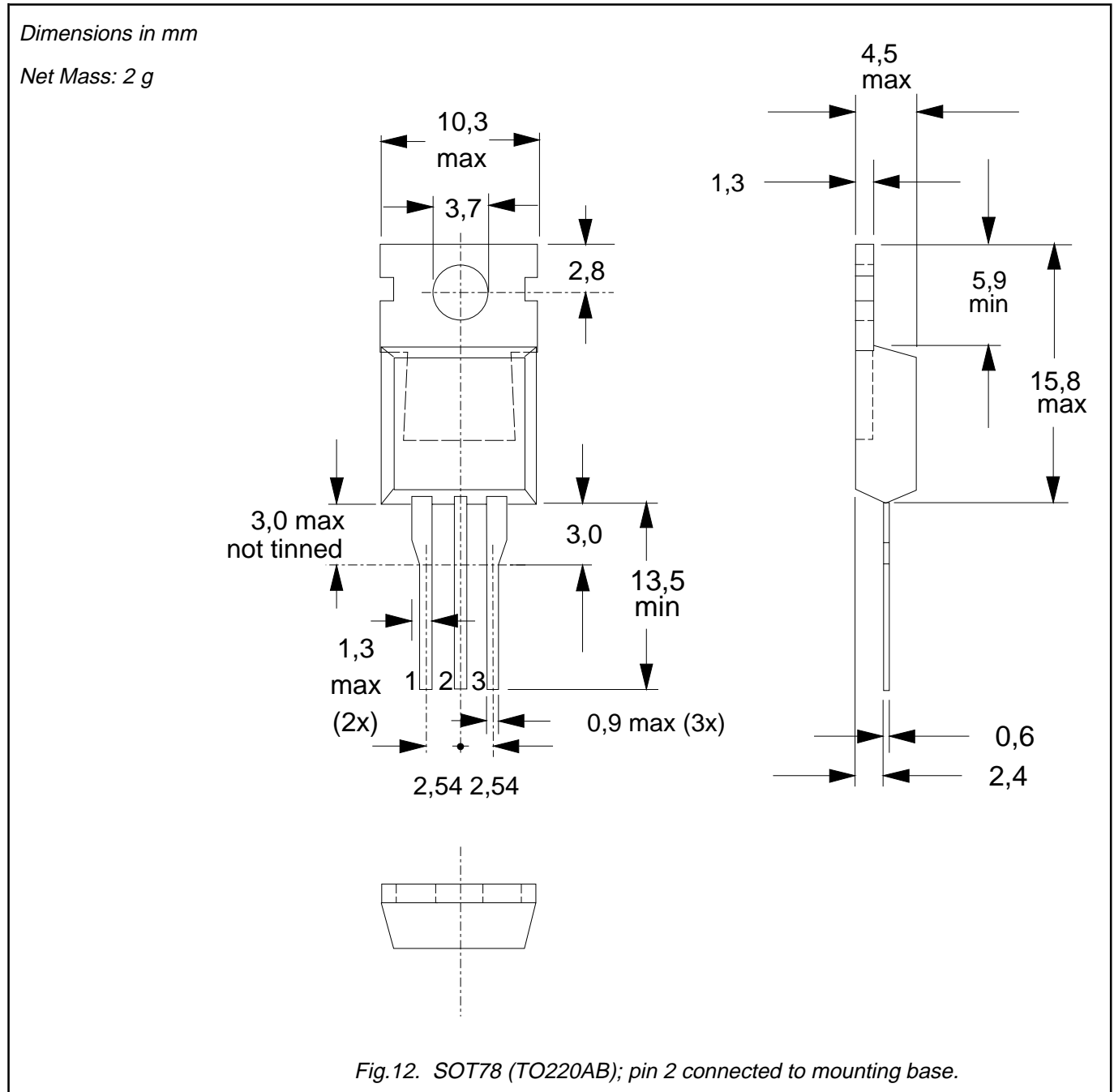

Notes

1. Refer to mounting instructions for SOT78 (TO220) envelopes.
2. Epoxy meets UL94 V0 at 1/8".

Rectifier diodes
ultrafast, rugged

BYV32E, BYV32EB series

MECHANICAL DATA

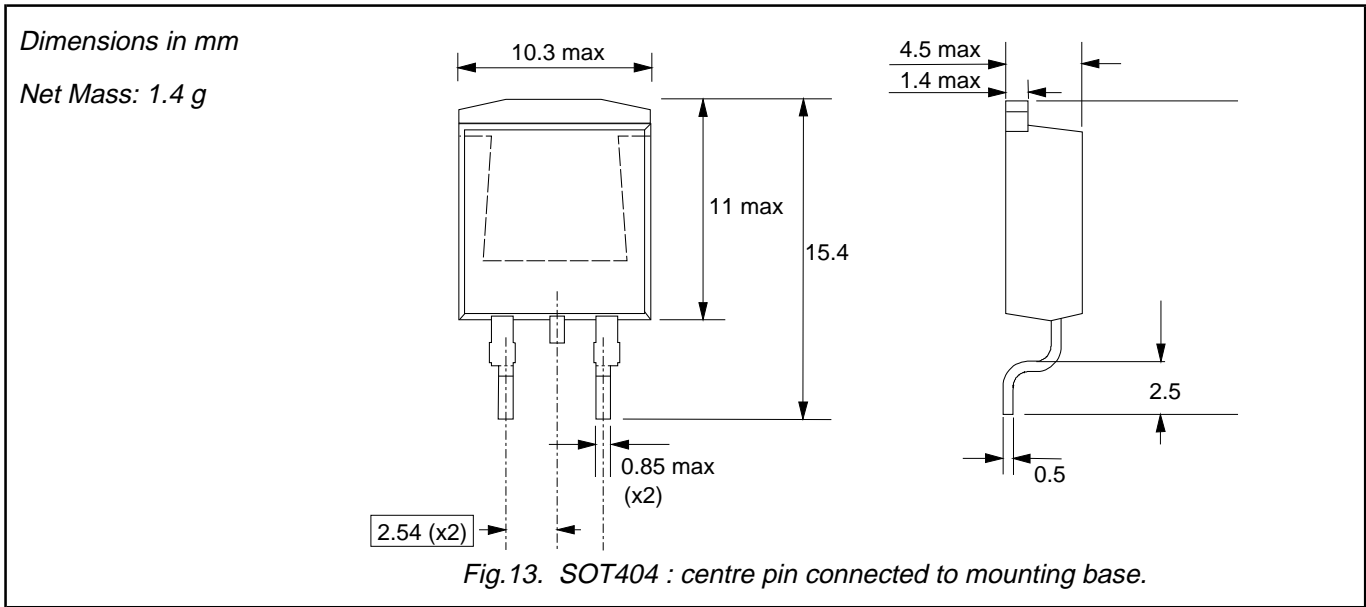

MOUNTING INSTRUCTIONS

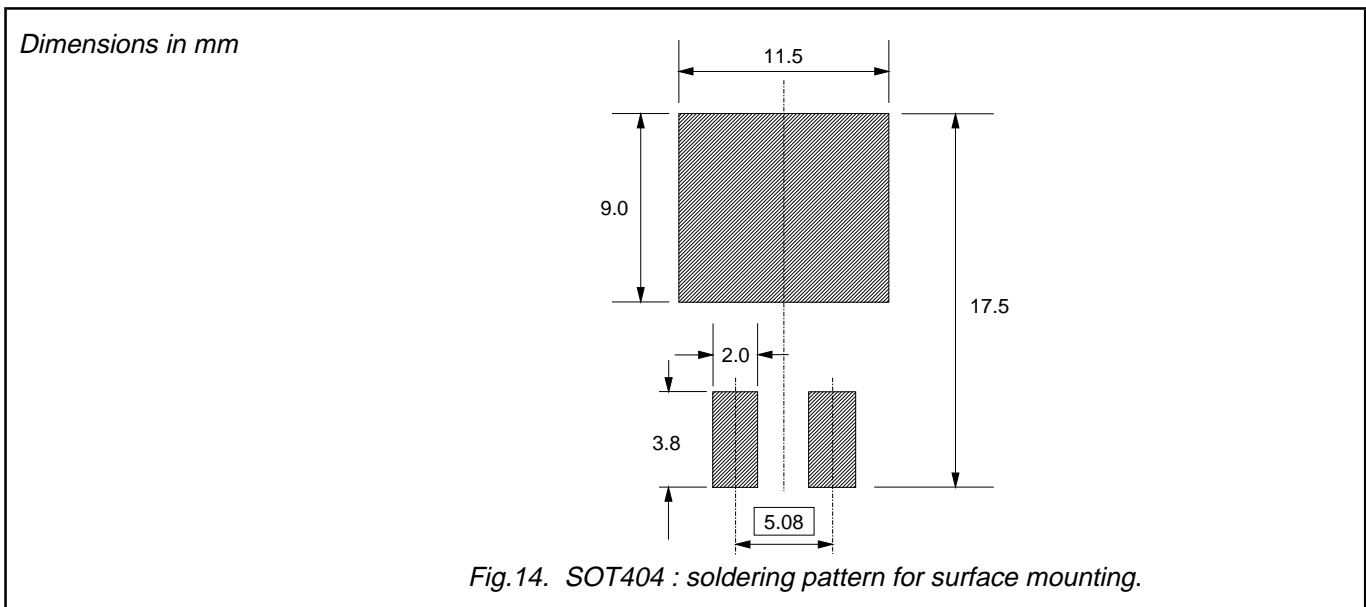

Notes

- 1. Epoxy meets UL94 V0 at 1/8".

Rectifier diodes
ultrafast, rugged

BYV32E, BYV32EB series

DEFINITIONS

Data sheet status	
Objective specification	This data sheet contains target or goal specifications for product development.
Preliminary specification	This data sheet contains preliminary data; supplementary data may be published later.
Product specification	This data sheet contains final product specifications.
Limiting values	
Limiting values are given in accordance with the Absolute Maximum Rating System (IEC 134). Stress above one or more of the limiting values may cause permanent damage to the device. These are stress ratings only and operation of the device at these or at any other conditions above those given in the Characteristics sections of this specification is not implied. Exposure to limiting values for extended periods may affect device reliability.	
Application information	
Where application information is given, it is advisory and does not form part of the specification.	
© Philips Electronics N.V. 1998	
All rights are reserved. Reproduction in whole or in part is prohibited without the prior written consent of the copyright owner.	
The information presented in this document does not form part of any quotation or contract, it is believed to be accurate and reliable and may be changed without notice. No liability will be accepted by the publisher for any consequence of its use. Publication thereof does not convey nor imply any license under patent or other industrial or intellectual property rights.	

LIFE SUPPORT APPLICATIONS

These products are not designed for use in life support appliances, devices or systems where malfunction of these products can be reasonably expected to result in personal injury. Philips customers using or selling these products for use in such applications do so at their own risk and agree to fully indemnify Philips for any damages resulting from such improper use or sale.



LittleDiode supplies new, hard to find or obsolete electronic components and semiconductors all over the world.

With over two million different components listed you are sure to find the part you need.

Feel free to visit us today at our online store:

LittleDiode.com

Looking forward to providing you with the best possible service.