

## POWER DIODE MODULE

### Features

- All the terminals and the mounting plate are electrically isolated. These modules can be installed in the same cooling fin as other modules, thus saving installation space – a cost-effective feature.
- The diode chips are coated with a glass of zinc oxide, making them highly resistant to temperature and humidity variation.
- Two diodes chips are connected in series internally, so allowing the rectifying circuit to be simplified.

### Applications

- Inverters for AC motors
- Power supply units for DC motors
- DC power supply units for battery chargers
- General purpose DC power supply units

### Outline Drawings

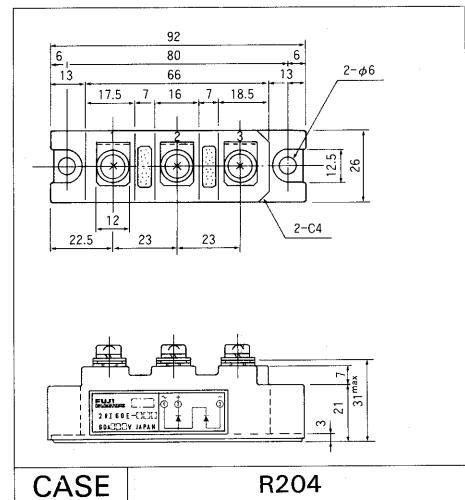

### Inner Circuit Schematic

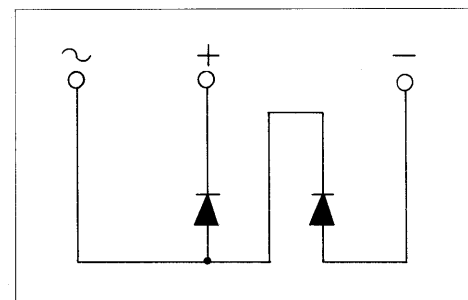

## Maximum Ratings and Characteristics

### Absolute Maximum Ratings

Items	Symbols	Conditions	2RI60E		Units
			-060	-080	
Repetitive peak reverse voltage	$V_{RRM}$		600	800	V
Non-repetitive peak reverse voltage	$V_{RSM}$		660	880	V
Average forward current	$I_{F(AV)}$	50/60 Hz Sinewave, $T_C = 103^\circ\text{C}$	60×2		A
Surge current	$I_{FSM}$	Rated load conditions	1200		A
$I^2_t$	$I^2_t$	Rated load conditions	6000		$\text{A}^2\text{s}$
Junction temperature	$T_j$		-40~+150		$^\circ\text{C}$
Storage temperature	$T_{stg}$		-40~+150		$^\circ\text{C}$
Tightening torque		Mounting screw: M5	25±5		kg·cm
Vibration resistance			5		G
Dielectric strength		Between terminals and base	2000 VAC 1min		
Net. Weight			180		g

### Electrical Characteristics

Items	Symbols	Conditions	Min	Typ	Max	Units
Forward voltage	$V_{FM}$	$T_j = 25^\circ\text{C}$ , $I_{FM} = 190\text{ A}$			1.30	V
Reverse current	$I_{RRM}$	$T_j = 150^\circ\text{C}$ , $V_R = V_{RRM}$			20	mA

### Thermal Characteristics

Items	Symbols	Conditions	Min	Typ	Max	Units
Thermal resistance (Junction to case)	$R_{th(j-c)}$	50/60 Hz Sinewave, Thermal resistance for total loss			0.25	$^\circ\text{C}/\text{W}$
Thermal resistance	$R_{th(c-f)}$	With thermal compound			0.10	$^\circ\text{C}/\text{W}$

■ Characteristic curves

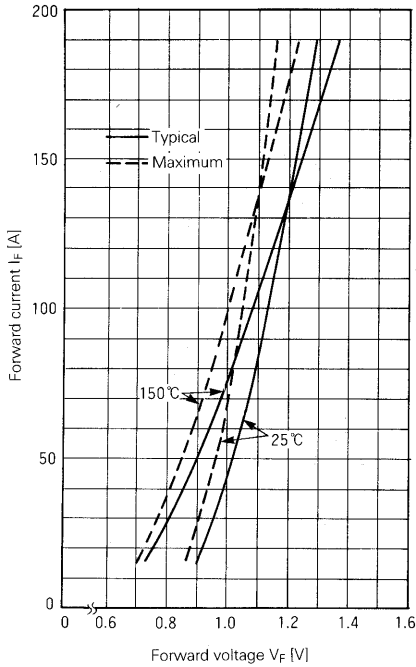

Forward Characteristics

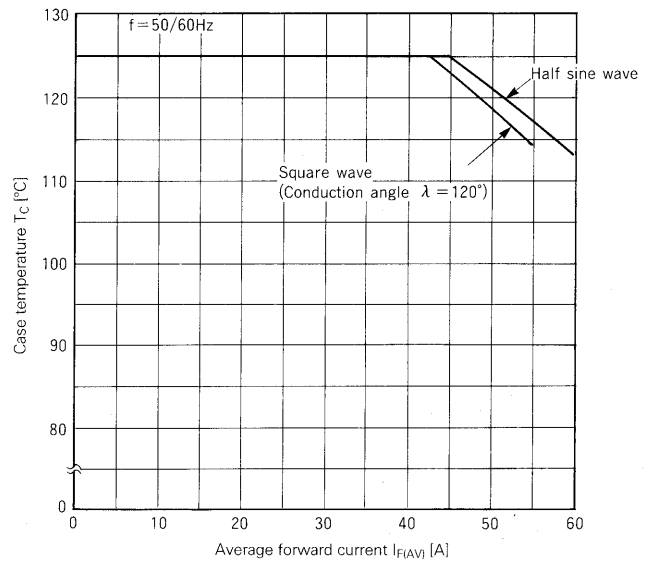

Case Temperature-Forward Average Current

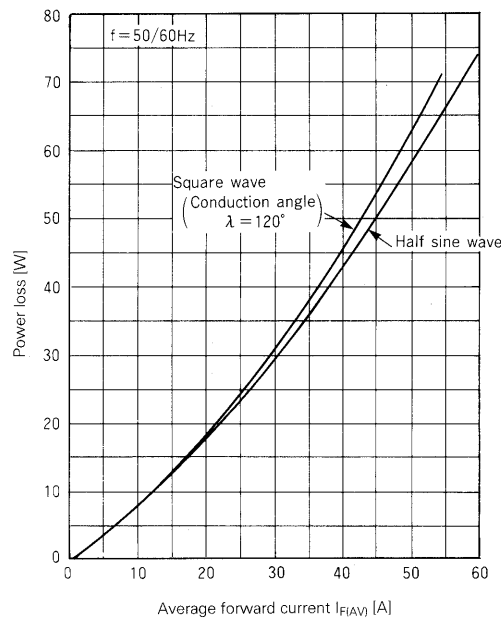

Power Loss-Average Forward Current

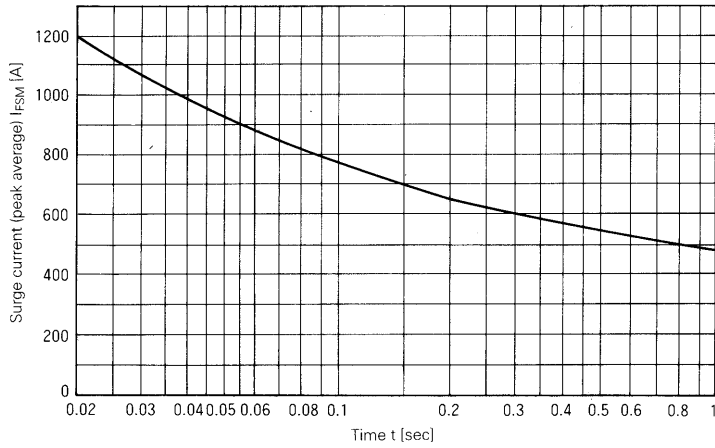

Surge Current

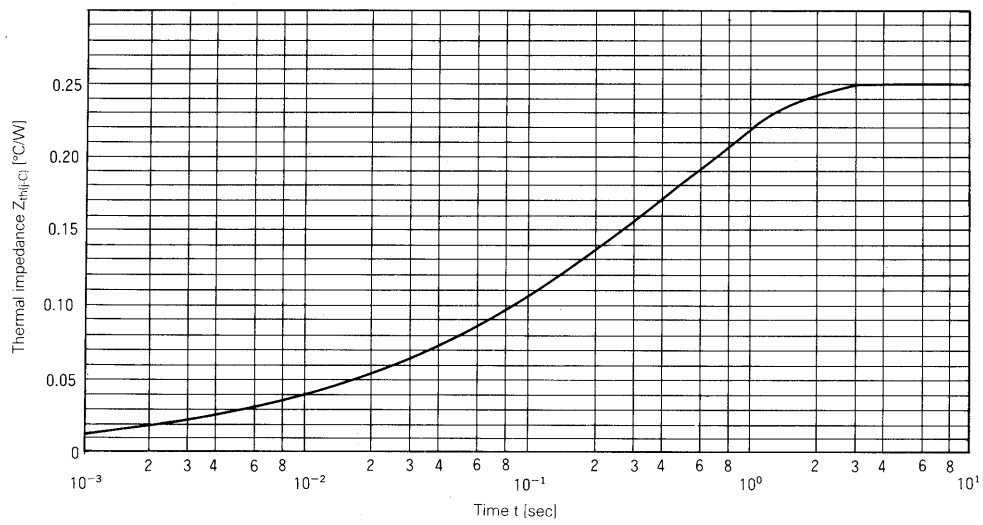

Transient Thermal Impedance

For more information, contact:

**Collmer Semiconductor, Inc.**

P.O. Box 702708

Dallas, TX 75370

972-733-1700

972-381-9991 Fax

<http://www.collmer.com>



LittleDiode supplies new, hard to find or obsolete electronic components and semiconductors all over the world.

With over two million different components listed you are sure to find the part you need.

Feel free to visit us today at our online store:

[LittleDiode.com](http://LittleDiode.com)

Looking forward to providing you with the best possible service.