

POWER DIODE MODULE

Features

- All the terminals and the mounting plate are electrically isolated. These modules can be installed in the same cooling fin as other modules, thus saving installation space – a cost-effective feature.
- The diode chips are coated with a glass of zinc oxide, making them highly resistant to temperature and humidity variation.
- 6 diode chips are connected to the 3-phase bridge rectifying circuit inside the module-a cost-effective feature.

Applications

- Inverters for AC motors
- Power supply units for DC motors
- DC power supply units for battery chargers
- General purpose DC power supply units

Outline Drawings

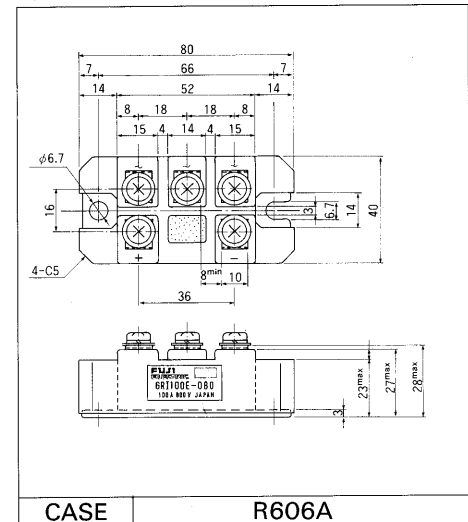

Inner Circuit Schematic

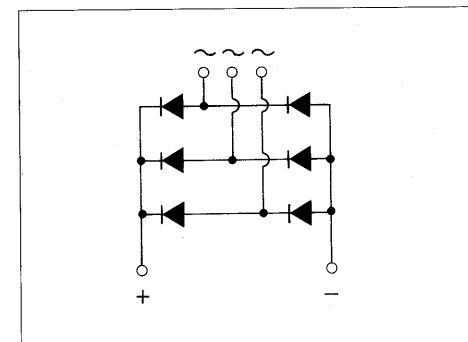

Maximum Ratings and Characteristics

Absolute Maximum Ratings

Items	Symbols	Conditions	6RI100E		Units
			-060	-080	
Repetitive peak reverse voltage	V_{RRM}		600	800	V
Non-repetitive peak reverse voltage	V_{RSM}		660	880	V
Average output current	I_O	50/60 Hz Sinewave, $T_C = 103^\circ\text{C}$	100		A
Surge current	I_{FSM}	Rated load conditions	1200		A
I_t^2	I_t^2	Rated load conditions	6000		A ² s
Junction temperature	T_j		-40~+150		°C
Storage temperature	T_{stg}		-40~+125		°C
Tightening torque		Mounting screw: M5	25±2		kg·cm
Vibration resistance			5		G
Dielectric strength		Between terminals and base	2000 VAC 1 min		
Net. Weight			150		g

Electrical Characteristics

Items	Symbols	Conditions	Min	Typ	Max	Units
Forward voltage	V_{FM}	$T_j = 25^\circ\text{C}$, $I_{FM} = 100\text{ A}$			1.15	V
Reverse current	I_{RRM}	$T_j = 150^\circ\text{C}$, $V_R = V_{RRM}$			10	mA

Thermal Characteristics

Items	Symbols	Conditions	Min	Typ	Max	Units
Thermal resistance (Junction to case)	$R_{th(j-c)}$	50/60 Hz Sinewave, Thermal resistance for total loss			0.22	°C/W
Thermal resistance	$R_{th(c-f)}$	With thermal compound			0.06	°C/W

■ Characteristic curves

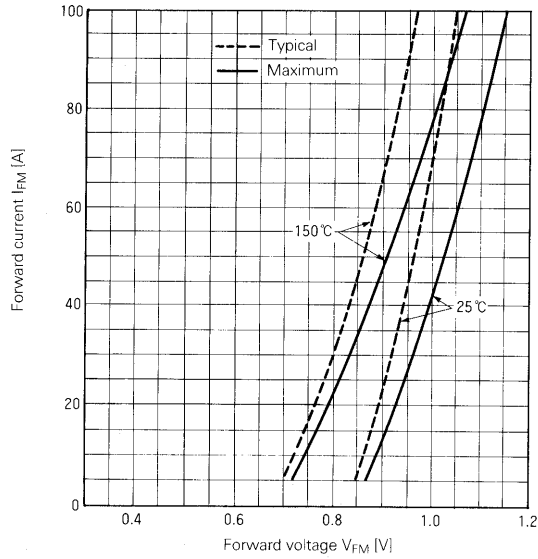

Forward Characteristics

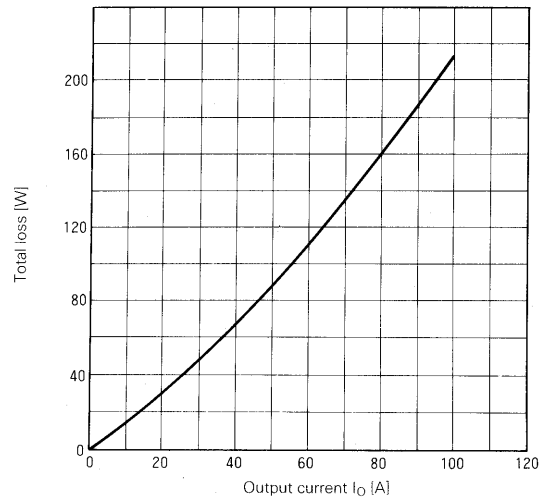

Total Loss-Output Current

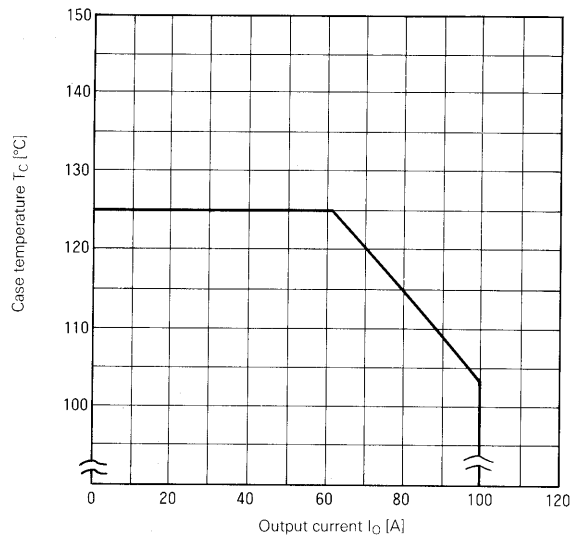

Case Temperature-Output Current

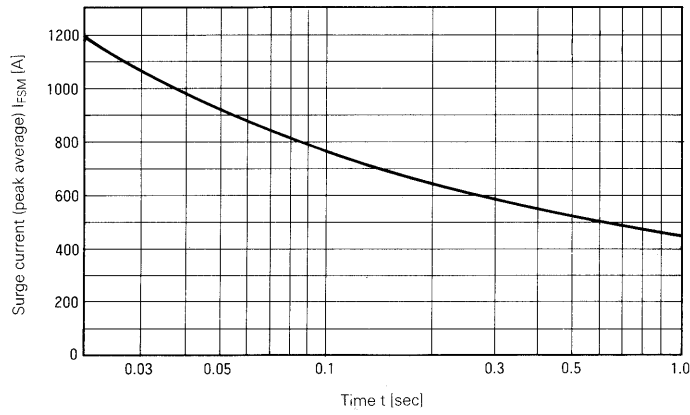

Surge Current

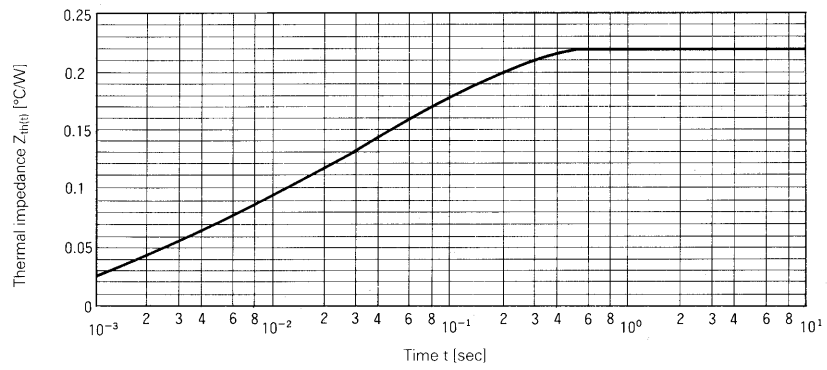

For more information, contact:

Collmer Semiconductor, Inc.

P.O. Box 702708

Dallas, TX 75370

972-733-1700

972-381-9991 Fax

<http://www.collmer.com>



LittleDiode supplies new, hard to find or obsolete electronic components and semiconductors all over the world.

With over two million different components listed you are sure to find the part you need.

Feel free to visit us today at our online store:

LittleDiode.com

Looking forward to providing you with the best possible service.