

International  
**IR** Rectifier

**SAFEIR** Series  
70TPS..

## PHASE CONTROL SCR

	$V_T < 1.4V @ 100A$ $I_{TSM} = 1400A$ $V_{RRM} = 1200, 1600V$
---	---

### Description/ Features

The 70TPS... **SAFEIR** series of silicon controlled rectifiers are specifically designed for high and medium power switching and phase control applications.

Typical applications are in input rectification (soft start) or AC-Switches or high current crow-bar as well as others phase-control circuits.

These products are designed to be used with International Rectifier input diodes, switches and output rectifiers which are available in identical package outlines.

### Major Ratings and Characteristics

Characteristics	70TPS..	Units
$I_{T(AV)}$ Sinusoidal waveform	70	A
$I_{RMS}$ (*)	75	A
$V_{RRM}/V_{DRM}$ Range	1200, 1600	V
$I_{TSM}$	1400	A
$V_T$ @ 100 A, $T_J = 25^\circ C$	1.4	V
dv/dt	500	V/ $\mu s$
di/dt	150	A/ $\mu s$
$T_J$	-40 to 125	$^\circ C$

(\*) Lead current limitation

### Package Outline



Super-247

## Voltage Ratings

Part Number	$V_{RRM}/V_{DRM}$ , max. repetitive peak and off-state voltage V	$V_{RSM}$ , maximum non repetitive peak reverse voltage V	$I_{RRM}/I_{DRM}$ 125°C mA
70TPS12	1200	1300	15
70TPS16	1600	1700	

## Absolute Maximum Ratings

Parameters	70TPS..	Units	Conditions	
$I_{T(AV)}$ Max. Average On-state Current	70	A	@ $T_C = 82^\circ\text{C}$ , 180° conduction half sine wave	
$I_{T(RMS)}$ Max. Continuous RMS On-state Current As AC switch	75		Lead current limitation	
$I_{TSM}$ Max. Peak One Cycle Non-Repetitive Surge Current	1200	A	10ms Sine pulse, rated $V_{RRM}$ applied	Initial $T_J = T_{J\text{max}}$ .
	1400		10ms Sine pulse, no voltage reapplied	
$I^2t$ Max. $I^2t$ for Fusing	7200	$A^2s$	10ms Sine pulse, rated $V_{RRM}$ applied	
	10200		10ms Sine pulse, no voltage reapplied	
$I^2\sqrt{t}$ Max. $I^2\sqrt{t}$ for Fusing	102000	$A^2\sqrt{s}$	$t = 0.1$ to 10ms, no voltage reapplied	
$V_{T(TO)1}$ Low Level Value of Threshold Voltage	0.916	V	$T_J = 125^\circ\text{C}$	
$V_{T(TO)2}$ High Level Value of Threshold Voltage	1.21			
$r_{t1}$ Low Level Value of On-state Slope Resistance	4.138			
$r_{t2}$ High Level Value of On-state Slope Resistance	3.43			
$V_{TM}$ Max. Peak On-state Voltage	1.4	V	@ 100A, $T_J = 25^\circ\text{C}$	
$di/dt$ Max. Rate of Rise of Turned-on Current	150	A/ $\mu s$	$T_J = 25^\circ\text{C}$	
$I_H$ Max. Holding Current	200	mA	$T_J = 25^\circ\text{C}$	
$I_L$ Max. Latching Current	400			
$I_{RRM}$ / Max. Reverse and Direct	1.0	mA	$T_J = 25^\circ\text{C}$	$V_R = \text{rated } V_{RRM}/V_{DRM}$
$I_{DRM}$ Leakage Current	15		$T_J = 125^\circ\text{C}$	
$dv/dt$ Max. Rate of Rise	500		V/ $\mu s$	

### Triggering

Parameters	70TPS..	Units	Conditions		
$P_{GM}$ Max. peak Gate Power	10	W	$t = 30\mu s$		
$P_{G(AV)}$ Max. average Gate Power	2.5				
$I_{GM}$ Max. peak Gate Current	2.5	A			
$-V_{GM}$ Max. peak negative Gate Voltage	10	V			
$V_{GT}$ Max. required DC Gate Voltage to trigger	4.0		$T_J = -40^\circ C$	Anode supply = 6V resistive load	
	1.5		$T_J = 25^\circ C$		
	1.1		$T_J = 125^\circ C$		
$I_{GT}$ Max. required DC Gate Current to trigger	270	mA	$T_J = -40^\circ C$		
	100		$T_J = 25^\circ C$		
	80		$T_J = 125^\circ C$		
$V_{GD}$ Max. DC Gate Voltage not to trigger	0.25	V	$T_J = 125^\circ C, V_{DRM} = \text{rated value}$		
$I_{GD}$ Max. DC Gate Current not to trigger	6	mA			

### Thermal-Mechanical Specifications

Parameters	70TPS..	Units	Conditions	
$T_J$ Max. Junction Temperature Range	-40 to 125	°C		
$T_{stg}$ Max. Storage Temperature Range	-40 to 150			
$R_{thJC}$ Max. Thermal Resistance Junction to Case	0.27	°C/W	DC operation	
$R_{thJA}$ Max. Thermal Resistance Junction to Ambient	40			
$R_{thCS}$ Max. Thermal Resistance Case to Heatsink	0.2		Mounting surface, smooth and greased	
wt Approximate Weight	6 (0.21)	g (oz.)		
T Mounting Torque	Min. 6 (5)	Kg-cm (lbf-in)		
	Max. 12 (10)			
Case Style	Super-247			

### $\Delta R$ Conduction (per Junction)

(The following table shows the increment of thermal resistance  $R_{thJC}$  when devices operate at different conduction angles than DC)

Device	Sine half wave conduction					Rect. wave conduction					Units
	180°	120°	90°	60°	30°	180°	120°	90°	60°	30°	
70TPS	0.078	0.092	0.117	0.172	0.302	0.053	0.092	0.125	0.180	0.306	°C/W

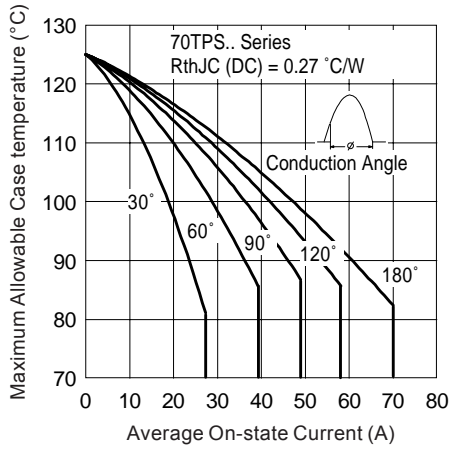

Fig. 1 - Current Rating Characteristics

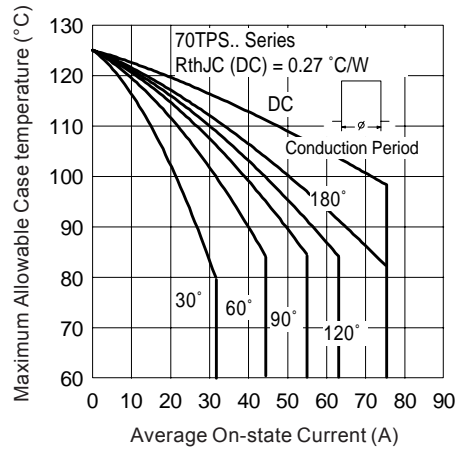

Fig. 2 - Current Rating Characteristics

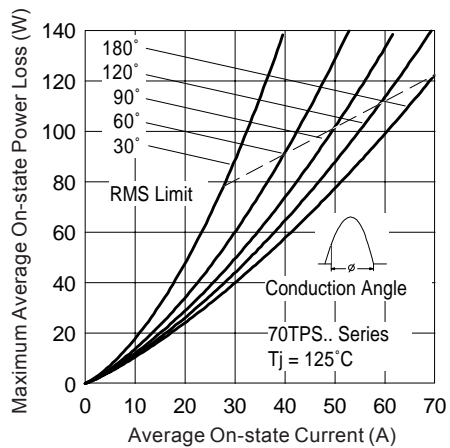

Fig. 3 - On-state Power Loss Characteristics

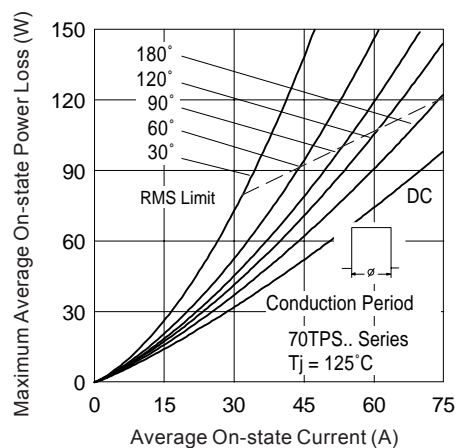

Fig. 4 - On-state Power Loss Characteristics

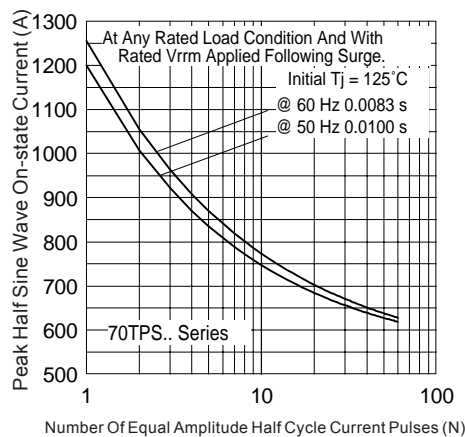

Fig. 5 - Maximum Non-Repetitive Surge Current

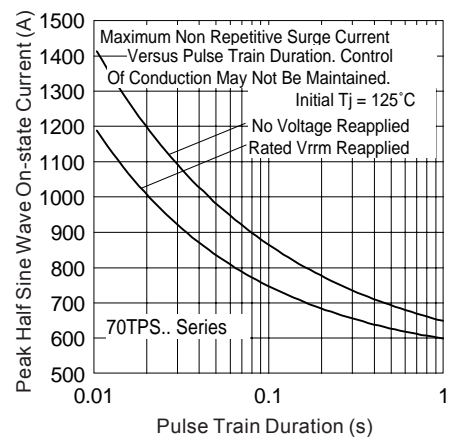

Fig. 6 - Maximum Non-Repetitive Surge Current

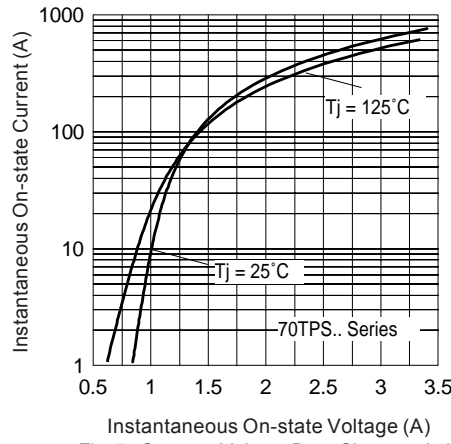

Fig. 7 - On-state Voltage Drop Characteristics

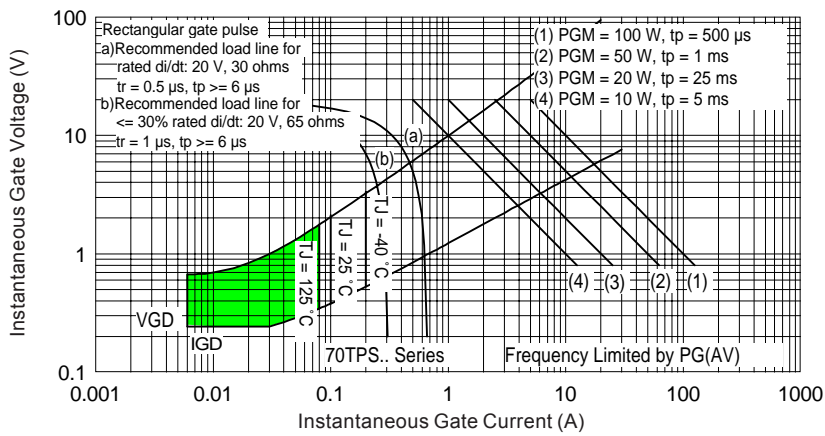

Fig. 8 - Gate Characteristics

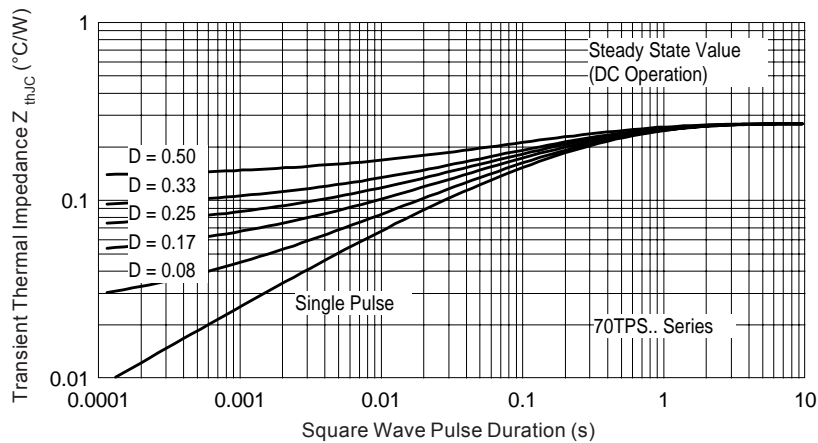
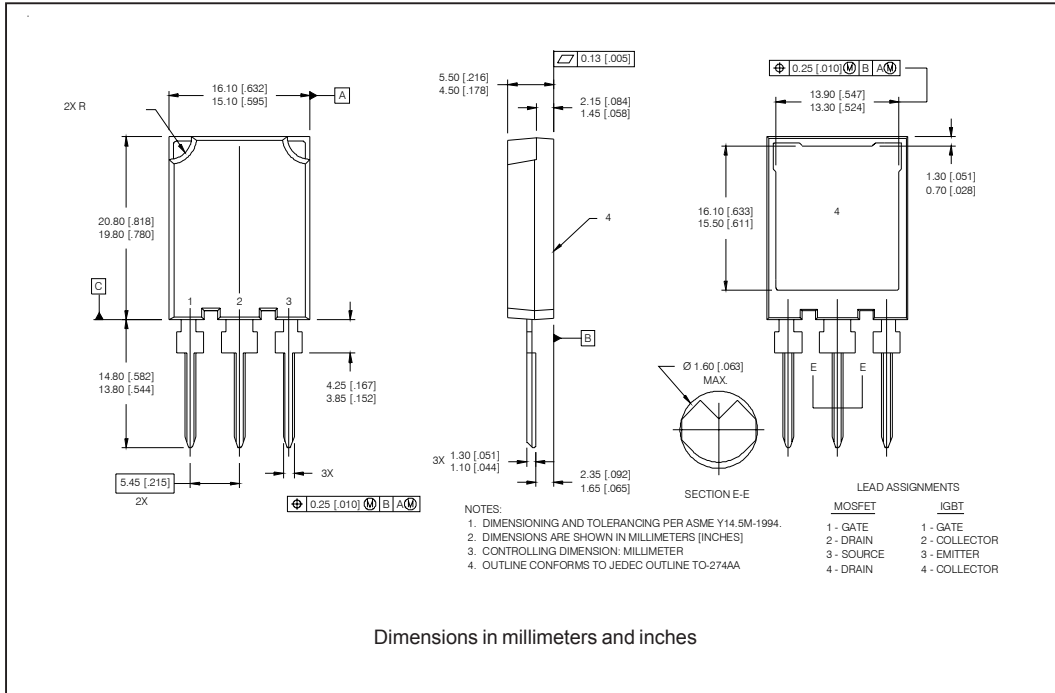
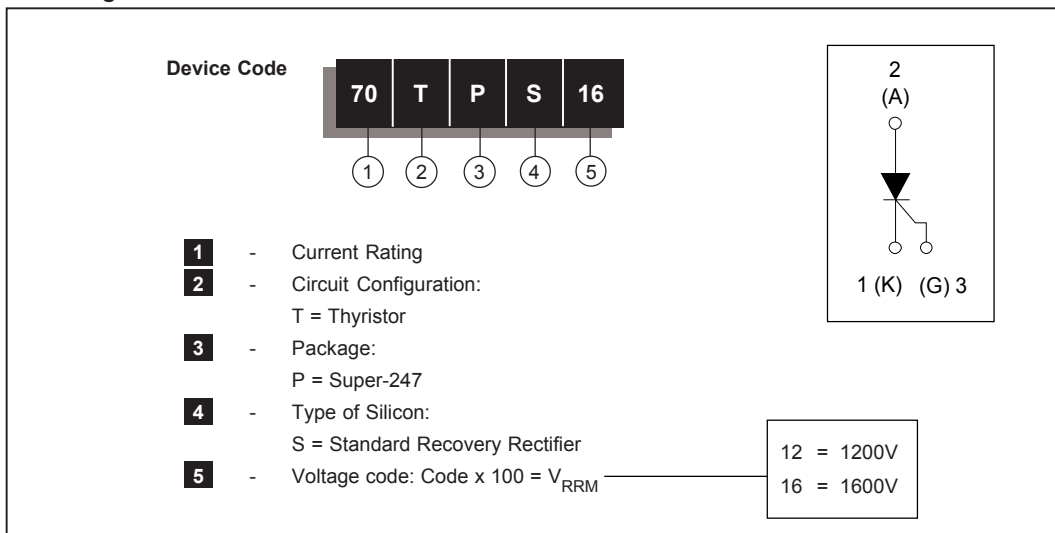

Fig. 9 - Thermal Impedance  $Z_{thJC}$  Characteristics

Outline Table



Ordering Information Table



Data and specifications subject to change without notice.  
This product has been designed for Industrial Level.  
Qualification Standards can be found on IR's Web site.

International  
**IOR** Rectifier

**IR WORLD HEADQUARTERS:** 233 Kansas St., El Segundo, California 90245, USA Tel: (310) 252-7105  
TAC Fax: (310) 252-7309  
Visit us at [www.irf.com](http://www.irf.com) for sales contact information. 03/04



LittleDiode supplies new, hard to find or obsolete electronic components and semiconductors all over the world.

With over two million different components listed you are sure to find the part you need.

Feel free to visit us today at our online store:

[LittleDiode.com](http://LittleDiode.com)

Looking forward to providing you with the best possible service.