

74VHCT04A Hex Inverter

General Description

The VHCT04A is an advanced high speed CMOS Inverter fabricated with silicon gate CMOS technology. It achieves the high speed operation similar to equivalent Bipolar Schottky TTL while maintaining the CMOS low power dissipation.

The internal circuit is composed of 3 stages including buffer output, which provide high noise immunity and stable output.

Protection circuits ensure that 0V to 7V can be applied to the input pins without regard to the supply voltage and to the output pins with $V_{CC} = 0V$. These circuits prevent device destruction due to mismatched supply and input/output voltages. This device can be used to interface 3V to

5V systems and two supply systems such as battery backup.

Features

- High speed: $t_{PD} = 4.7$ ns (typ) at $T_A = 25^\circ C$
- High noise immunity: $V_{IH} = 2.0V$, $V_{IL} = 0.8V$
- Power down protection is provided on all inputs and outputs
- Low noise: $V_{OLP} = 1.0V$ (max)
- Low power dissipation:
 $I_{CC} = 2 \mu A$ (max) @ $T_A = 25^\circ C$
- Pin and function compatible with 74HCT04

Ordering Code:

Order Number	Package Number	Package Description
74VHCT04AM	M14A	14-Lead Small Outline Integrated Circuit (SOIC), JEDEC MS-120, 0.150 Narrow
74VHCT04ASJ	M14D	14-Lead Small Outline Package (SOP), EIAJ TYPE II, 5.3mm Wide
74VHCT04AMTC	MTC14	14-Lead Thin Shrink Small Outline Package (TSSOP), JEDEC MO-153, 4.4mm Wide
74VHCT04AN	N14A	14-Lead Plastic Dual-In-Line Package (PDIP), JEDEC MS-001, 0.300 Wide

Surface mount packages are also available on Tape and Reel. Specify by appending the suffix letter "X" to the ordering code.

Logic Symbol

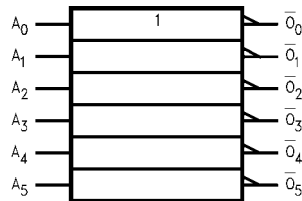

Connection Diagram

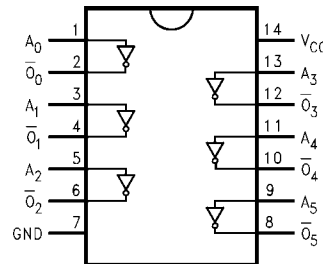

Pin Descriptions

Pin Names	Description
A_n	Inputs
\bar{O}_n	Outputs

Truth Table

A	\bar{O}
L	H
H	L

Absolute Maximum Ratings (Note 1)

Supply Voltage (V_{CC})	-0.5V to +7.0V
DC Input Voltage (V_{IN})	-0.5V to +7.0V
DC Output Voltage (V_{OUT})	-0.5V to $V_{CC} + 0.5V$
(Note 2)	
(Note 3)	-0.5V to 7.0V
Input Diode Current (I_{IK})	-20 mA
Output Diode Current (I_{OK})	± 20 mA
(Note 4)	
DC Output Current (I_{OUT})	± 25 mA
DC V_{CC} /GND Current (I_{CC})	± 50 mA
Storage Temperature (T_{STG})	-65°C to +150°C
Lead Temperature (T_L)	260°C
(Soldering, 10 seconds)	

Recommended Operating Conditions (Note 5)

Supply Voltage (V_{CC})	4.5V to +5.5V
Input Voltage (V_{IN})	0V to +5.5V
Output Voltage (V_{OUT})	0V to V_{CC}
(Note 2)	
(Note 3)	0V to 5.5V
Operating Temperature (T_{OPR})	-40°C to +85°C
Input Rise and Fall Time (t_r, t_f)	$V_{CC} = 5.0V \pm 0.5V$ 0 ns/V – 20 ns/V

Note 1: Absolute Maximum Ratings are values beyond which the device may be damaged or have its useful life impaired. The databook specifications should be met, without exception, to ensure that the system design is reliable over its power supply, temperature, and output/input loading variables. Fairchild does not recommend operation outside databook specifications.

Note 2: HIGH or LOW state. I_{OUT} absolute maximum rating must be observed.

Note 3: $V_{CC} = 0V$.

Note 4: $V_{OUT} < GND, V_{OUT} > V_{CC}$ (Outputs Active)

Note 5: Unused inputs must be held HIGH or LOW. They may not float.

DC Electrical Characteristics

Symbol	Parameter	V_{CC} (V)	$T_A = 25^\circ\text{C}$			$T_A = -40^\circ\text{C to } +85^\circ\text{C}$		Units	Conditions
			Min	Typ	Max	Min	Max		
V_{IH}	HIGH Level Input Voltage	4.5	2.0			2.0		V	
		5.5	2.0			2.0			
V_{IL}	LOW Level Input Voltage	4.5			0.8		0.8	V	
		5.5			0.8		0.8		
V_{OH}	HIGH Level Output Voltage	4.5	4.40	4.50		4.40		V	$V_{IN} = V_{IL}$ $I_{OH} = -50 \mu\text{A}$ $I_{OH} = -8 \text{ mA}$
			3.94			3.80			
V_{OL}	LOW Level Output Voltage	4.5		0.0	0.1		0.1	V	$V_{IN} = V_{IH}$ $I_{OL} = 50 \mu\text{A}$ $I_{OL} = 8 \text{ mA}$
					0.36		0.44		
I_{IN}	Input Leakage Current	0 – 5.5			± 0.1		± 1.0	μA	$V_{IN} = 5.5V$ or GND
I_{CC}	Quiescent Supply Current	5.5			2.0		20.0	μA	$V_{IN} = V_{CC}$ or GND
I_{CCT}	Maximum I_{CC} /Input	5.5			1.35		1.50	mA	$V_{IN} = 3.4V$ Other Inputs = V_{CC} or GND
I_{OFF}	Output Leakage Current (Power Down State)	0.0			0.5		5.0	μA	$V_{OUT} = 5.5V$

Noise Characteristics

Symbol	Parameter	V_{CC} (V)	$T_A = 25^\circ\text{C}$		Units	Conditions
			Typ	Limits		
V_{OLP} (Note 6)	Quiet Output Maximum Dynamic V_{OL}	5.0	0.8	1.0	V	$C_L = 50 \text{ pF}$
V_{OLV} (Note 6)	Quiet Output Minimum Dynamic V_{OL}	5.0	-0.8	1.0	V	$C_L = 50 \text{ pF}$
V_{IHD} (Note 6)	Minimum HIGH Level Dynamic Input Voltage	5.0		2.0	V	$C_L = 50 \text{ pF}$
V_{ILD} (Note 6)	Maximum LOW Level Dynamic Input Voltage	5.0		0.8	V	$C_L = 50 \text{ pF}$

Note 6: Parameter guaranteed by design.

AC Electrical Characteristics

Symbol	Parameter	V _{CC} (V)	T _A = 25°C			T _A = -40°C to +85°C		Units	Conditions
			Min	Typ	Max	Min	Max		
t _{PHL}	Propagation Delay	5.0 ± 0.5	4.7	6.7	1.0	7.5	ns	C _L = 15 pF	
t _{PLH}			5.5	7.7	1.0	8.5		C _L = 50 pF	
C _{IN}	Input Capacitance		4	10		10	pF	V _{CC} = OPEN	
C _{PD}	Power Dissipation Capacitance		11				pF	(Note 7)	

Note 7: C_{PD} is defined as the value of the internal equivalent capacitance which is calculated from the operating current consumption without load. Average operating current can be obtained by the equation: I_{CC} (opr.) = C_{PD} * V_{CC} * f_{IN} + I_{CC}/6 (per gate).

Physical Dimensions inches (millimeters) unless otherwise noted

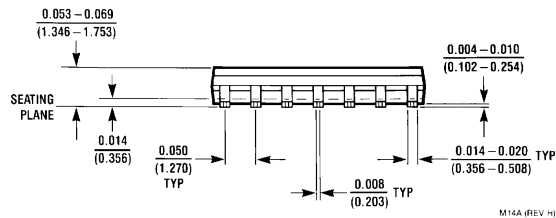
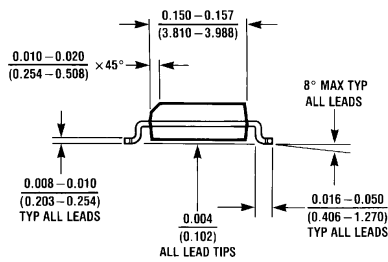
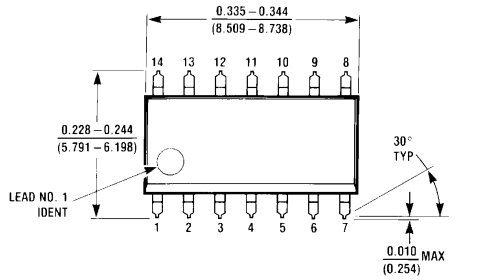

**14-Lead Small Outline Integrated Circuit (SOIC), JEDEC MS-120, 0.150 Narrow
Package Number M14A**

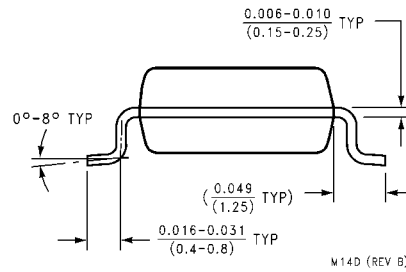
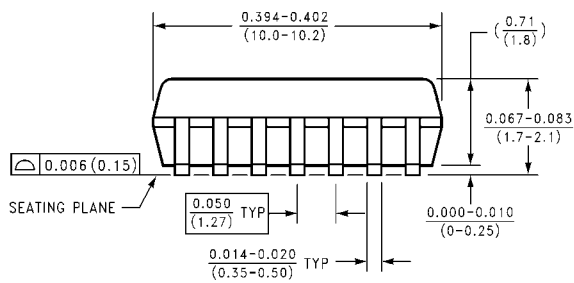
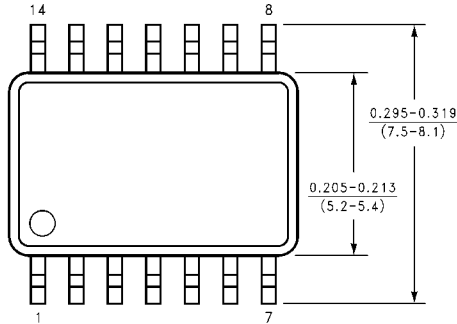

**14-Lead Small Outline Package (SOP), EIAJ TYPE II, 5.3mm Wide
Package Number M14D**

Physical Dimensions inches (millimeters) unless otherwise noted (Continued)

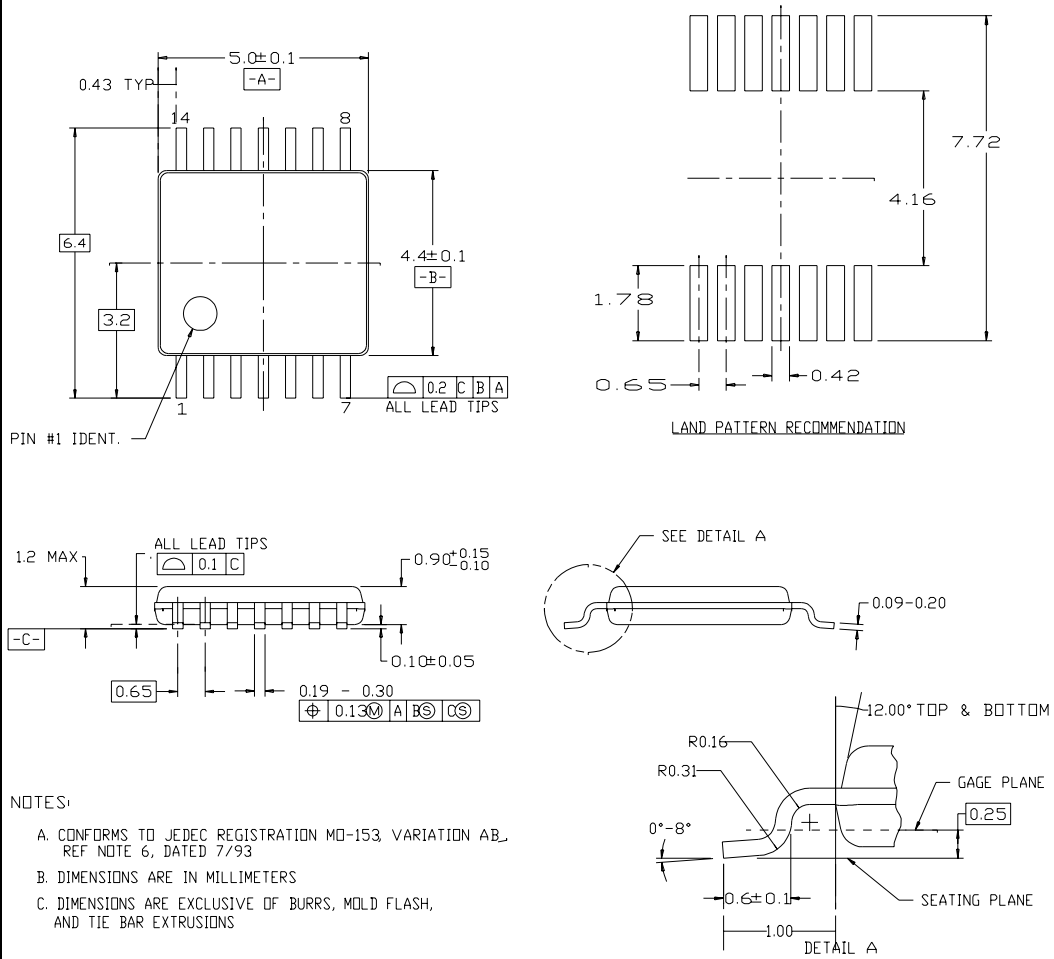

- NOTES:
- CONFORMS TO JEDEC REGISTRATION MO-153, VARIATION AB, REF NOTE 6, DATED 7/93
 - DIMENSIONS ARE IN MILLIMETERS
 - DIMENSIONS ARE EXCLUSIVE OF BURRS, MOLD FLASH, AND TIE BAR EXTRUSIONS

**14-Lead Thin Shrink Small Outline Package (TSSOP), JEDEC MO-153, 4.4mm Wide
Package Number MTC14**

Physical Dimensions inches (millimeters) unless otherwise noted (Continued)

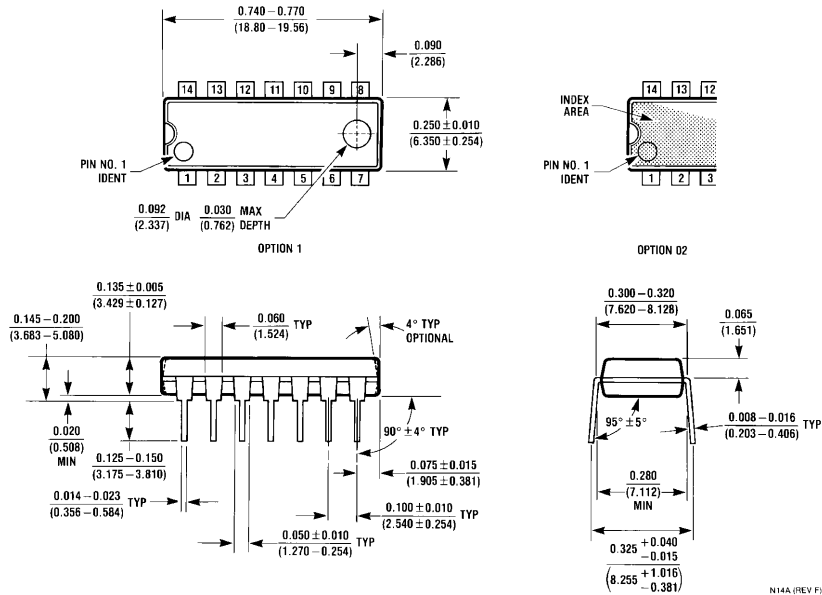

N14A (REV F)

LIFE SUPPORT POLICY

FAIRCHILD'S PRODUCTS ARE NOT AUTHORIZED FOR USE AS CRITICAL COMPONENTS IN LIFE SUPPORT DEVICES OR SYSTEMS WITHOUT THE EXPRESS WRITTEN APPROVAL OF THE PRESIDENT OF FAIRCHILD SEMICONDUCTOR CORPORATION. As used herein:

1. Life support devices or systems are devices or systems which, (a) are intended for surgical implant into the body, or (b) support or sustain life, and (c) whose failure to perform when properly used in accordance with instructions for use provided in the labeling, can be reasonably expected to result in a significant injury to the user.
2. A critical component in any component of a life support device or system whose failure to perform can be reasonably expected to cause the failure of the life support device or system, or to affect its safety or effectiveness.

www.fairchildsemi.com

This datasheet has been downloaded from:

www.DatasheetCatalog.com

Datasheets for electronic components.



LittleDiode supplies new, hard to find or obsolete electronic components and semiconductors all over the world.

With over two million different components listed you are sure to find the part you need.

Feel free to visit us today at our online store:

LittleDiode.com

Looking forward to providing you with the best possible service.