

Triacs

BT137X series

GENERAL DESCRIPTION

Glass passivated triacs in a full pack plastic envelope, intended for use in applications requiring high bidirectional transient and blocking voltage capability and high thermal cycling performance. Typical applications include motor control, industrial and domestic lighting, heating and static switching.

QUICK REFERENCE DATA

SYMBOL	PARAMETER	MAX.	MAX.	MAX.	UNIT
V_{DRM}	Repetitive peak off-state voltages	500	600	800	V
		500F	600F	800F	
		500G	600G	800G	
$I_{T(RMS)}$	RMS on-state current	8	8	8	A
I_{TSM}	Non-repetitive peak on-state current	65	65	65	A

PINNING - SOT186A

PIN	DESCRIPTION
1	main terminal 1
2	main terminal 2
3	gate
case	isolated

PIN CONFIGURATION

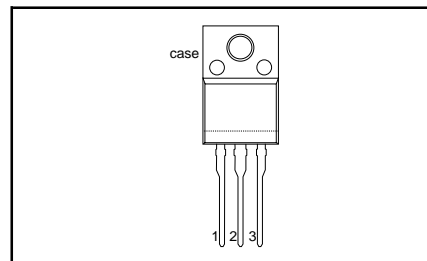

SYMBOL

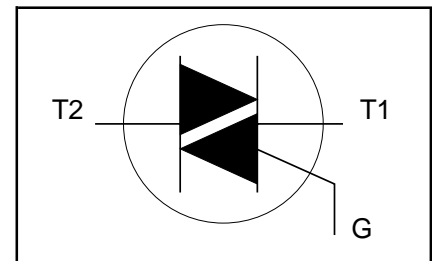

LIMITING VALUES

Limiting values in accordance with the Absolute Maximum System (IEC 134).

SYMBOL	PARAMETER	CONDITIONS	MIN.	MAX.			UNIT
				-500	-600	-800	
V_{DRM}	Repetitive peak off-state voltages		-	500 ¹	600 ¹	800	V
$I_{T(RMS)}$	RMS on-state current	full sine wave; $T_{hs} \leq 73^\circ C$	-	8			A
I_{TSM}	Non-repetitive peak on-state current	full sine wave; $T_j = 25^\circ C$ prior to surge $t = 20\text{ ms}$ $t = 16.7\text{ ms}$ $t = 10\text{ ms}$	-	65			A
I^2t	I^2t for fusing		-	71			A
di_T/dt	Repetitive rate of rise of on-state current after triggering	$I_{TM} = 12\text{ A}; I_G = 0.2\text{ A}; di_G/dt = 0.2\text{ A}/\mu s$	-	21			A ² s
I_{GM}	Peak gate current	T2+ G+	-	50			A/ μs
V_{GM}	Peak gate voltage	T2+ G-	-	50			A/ μs
P_{GM}	Peak gate power	T2- G-	-	50			A/ μs
$P_{G(AV)}$	Average gate power	T2- G+	-	10			A/ μs
T_{stg}	Storage temperature		-	2			A
T_j	Operating junction temperature		-	5			V
		over any 20 ms period	-	5			W
			-40	0.5			W
			-	150			$^\circ C$
			-	125			$^\circ C$

¹ Although not recommended, off-state voltages up to 800V may be applied without damage, but the triac may switch to the on-state. The rate of rise of current should not exceed 6 A/ μs .

Triacs

BT137X series

ISOLATION LIMITING VALUE & CHARACTERISTIC $T_{hs} = 25\text{ }^{\circ}\text{C}$ unless otherwise specified

SYMBOL	PARAMETER	CONDITIONS	MIN.	TYP.	MAX.	UNIT
V_{isol}	R.M.S. isolation voltage from all three terminals to external heatsink	$f = 50\text{-}60\text{ Hz}$; sinusoidal waveform; $R.H. \leq 65\%$; clean and dustfree	-		2500	V
C_{isol}	Capacitance from T2 to external heatsink	$f = 1\text{ MHz}$	-	10	-	pF

THERMAL RESISTANCES

SYMBOL	PARAMETER	CONDITIONS	MIN.	TYP.	MAX.	UNIT
$R_{th\ j-hs}$	Thermal resistance junction to heatsink	full or half cycle with heatsink compound	-	-	4.5	K/W
$R_{th\ j-a}$	Thermal resistance junction to ambient	without heatsink compound in free air	-	55	6.5	K/W

STATIC CHARACTERISTICS $T_j = 25\text{ }^{\circ}\text{C}$ unless otherwise stated

SYMBOL	PARAMETER	CONDITIONS	MIN.	TYP.	MAX.			UNIT
I_{GT}	Gate trigger current	$V_D = 12\text{ V}$; $I_T = 0.1\text{ A}$ BT137X- T2+ G+ T2+ G- T2- G- T2- G+	-	5F	...G	mA
			-	8	35	25	50	
			-	11	35	25	50	
			-	30	70	70	100	
			-	7	30	30	45	
I_L	Latching current	$V_D = 12\text{ V}$; $I_{GT} = 0.1\text{ A}$ T2+ G+ T2+ G- T2- G- T2- G+	-	7	30	30	45	mA
			-	16	45	45	60	
			-	5	30	30	45	
			-	7	45	45	60	
			-	5	20	20	40	
I_H	Holding current	$V_D = 12\text{ V}$; $I_{GT} = 0.1\text{ A}$	-	5	20	20	40	mA
V_T	On-state voltage	$I_T = 10\text{ A}$	-	1.3	1.65			V
V_{GT}	Gate trigger voltage	$V_D = 12\text{ V}$; $I_T = 0.1\text{ A}$	-	0.7	1.5			V
		$V_D = 400\text{ V}$; $I_T = 0.1\text{ A}$; $T_j = 125\text{ }^{\circ}\text{C}$	0.25	0.4	-			V
I_D	Off-state leakage current	$V_D = V_{DRM(max)}$; $T_j = 125\text{ }^{\circ}\text{C}$	-	0.1	0.5			mA

Triacs

BT137X series

DYNAMIC CHARACTERISTICS $T_j = 25\text{ °C}$ unless otherwise stated

SYMBOL	PARAMETER	CONDITIONS	MIN.			TYP.	MAX.	UNIT
		F	...G			
dV_D/dt	Critical rate of rise of off-state voltage	BT137X- $V_{DM} = 67\% V_{DRM(max)}$; $T_j = 125\text{ °C}$; exponential waveform; gate open circuit	100	50	200	250	-	V/ μ s
dV_{com}/dt	Critical rate of change of commutating voltage	$V_{DM} = 400\text{ V}$; $T_j = 95\text{ °C}$; $I_{T(RMS)} = 8\text{ A}$; $dl_{com}/dt = 3.6\text{ A/ms}$; gate open circuit	-	-	10	20	-	V/ μ s
t_{gt}	Gate controlled turn-on time	$I_{TM} = 12\text{ A}$; $V_D = V_{DRM(max)}$; $I_G = 0.1\text{ A}$; $dl_G/dt = 5\text{ A}/\mu$ s	-	-	-	2	-	μ s

Triacs

BT137X series

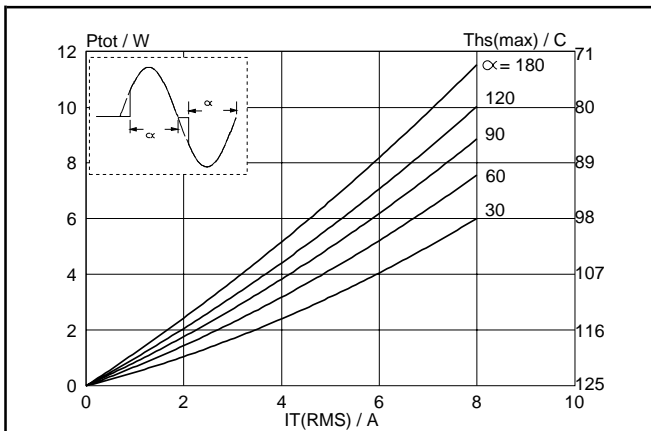

Fig.1. Maximum on-state dissipation, P_{tot} , versus rms on-state current, $I_{T(RMS)}$, where $\alpha =$ conduction angle.

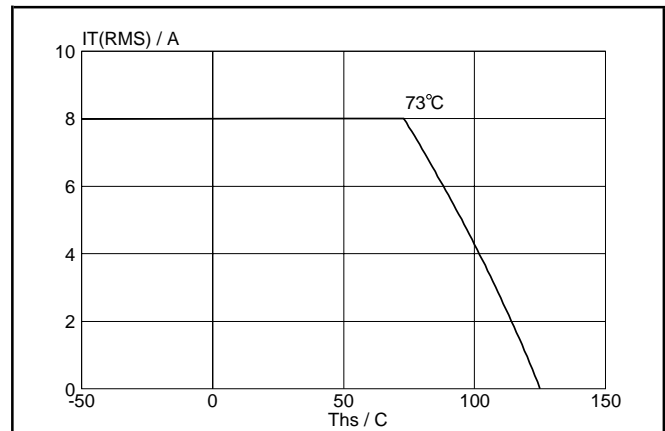

Fig.4. Maximum permissible rms current $I_{T(RMS)}$, versus heatsink temperature T_{hs} .

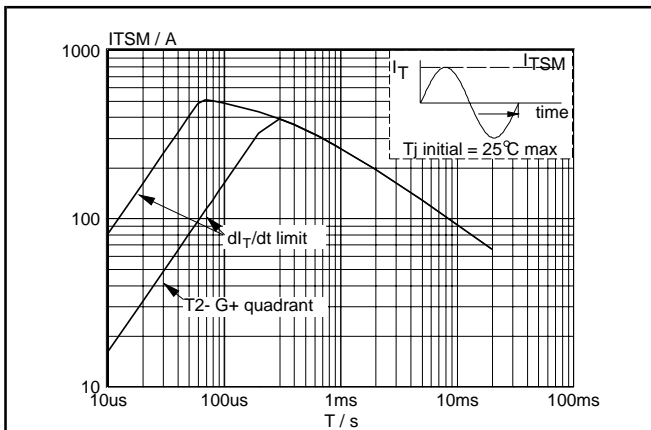

Fig.2. Maximum permissible non-repetitive peak on-state current I_{TSM} , versus pulse width t_p , for sinusoidal currents, $t_p \leq 20ms$.

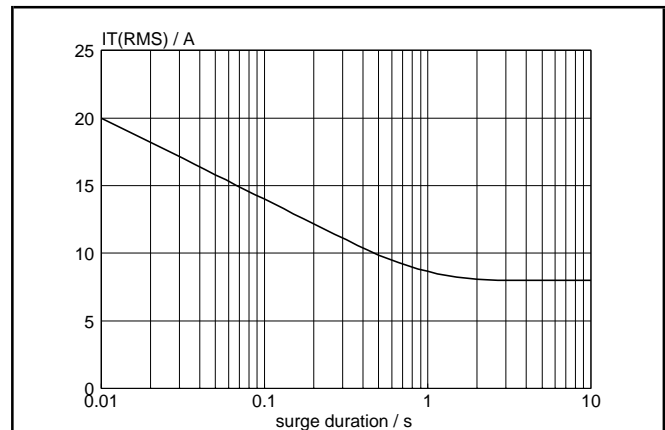

Fig.5. Maximum permissible repetitive rms on-state current $I_{T(RMS)}$, versus surge duration, for sinusoidal currents, $f = 50$ Hz; $T_{hs} \leq 73$ C.

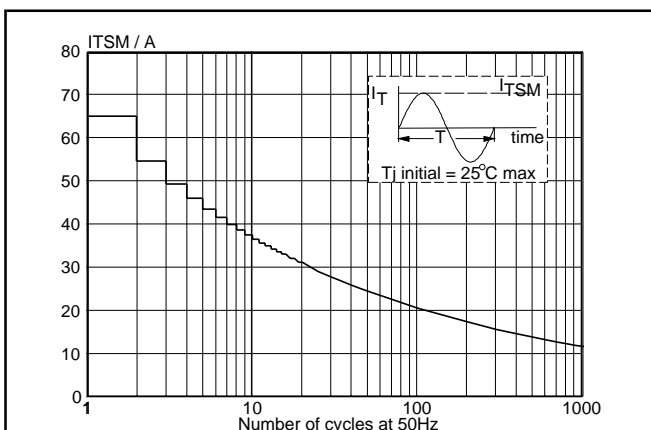

Fig.3. Maximum permissible non-repetitive peak on-state current I_{TSM} , versus number of cycles, for sinusoidal currents, $f = 50$ Hz.

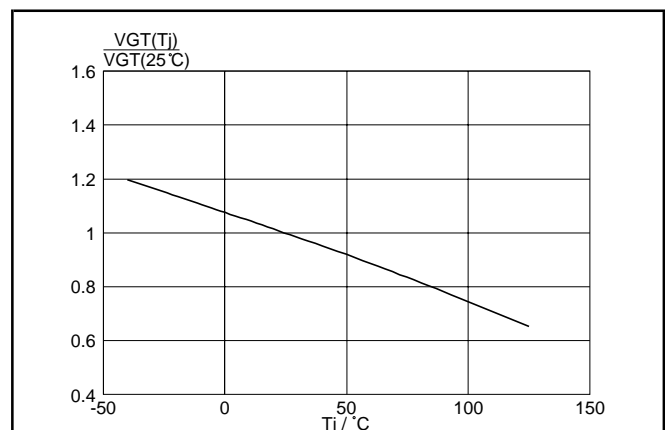
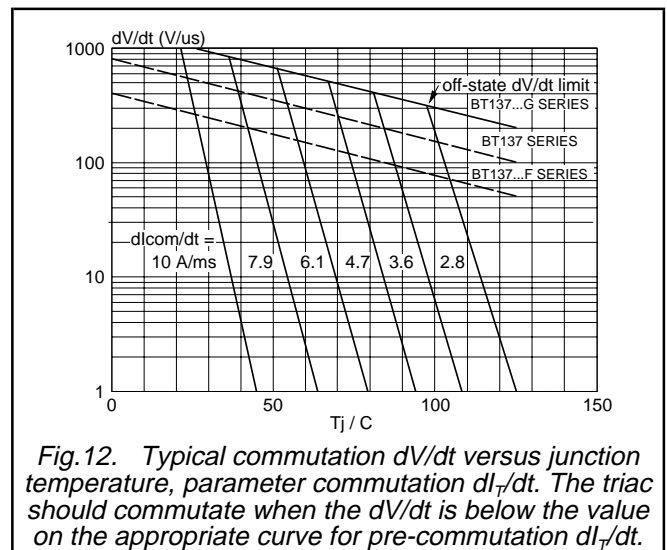
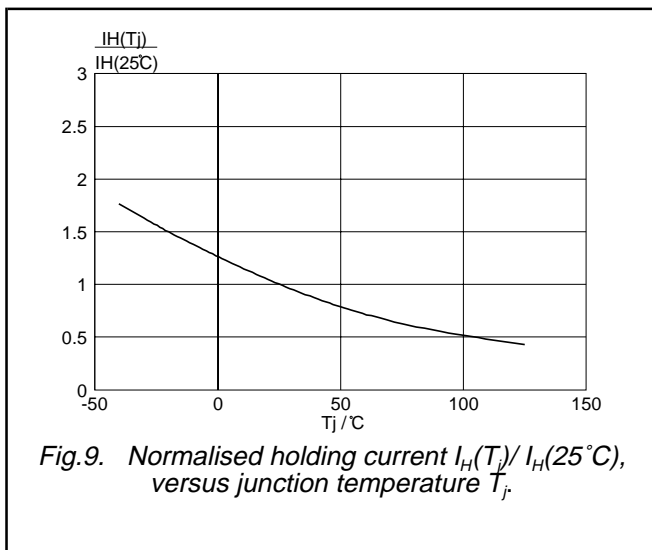
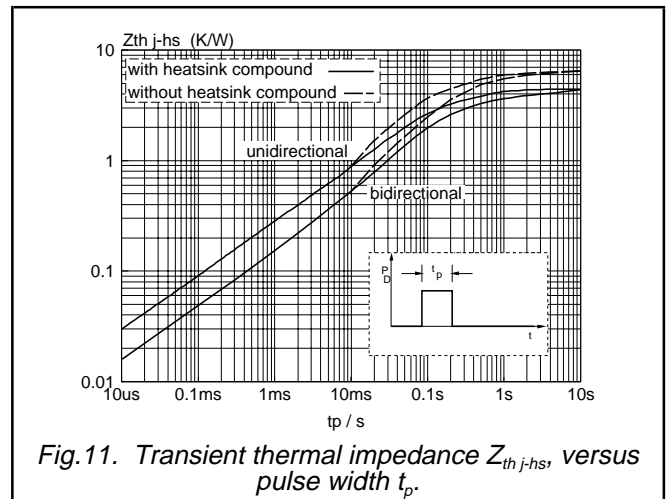
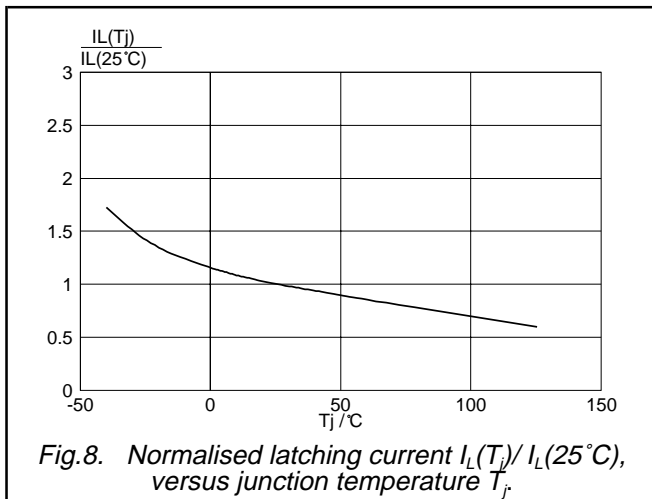
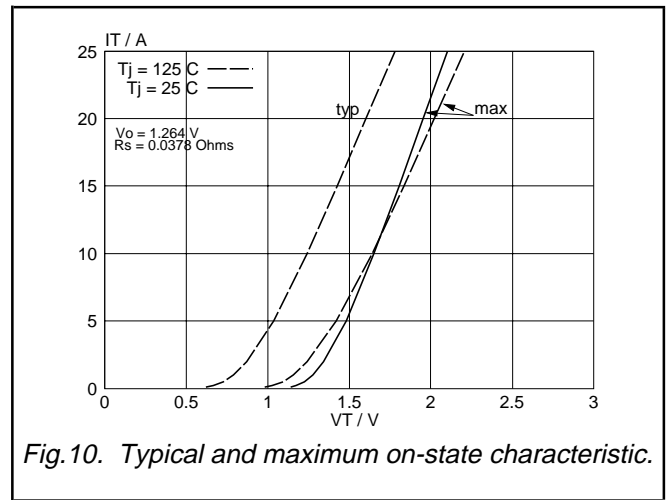
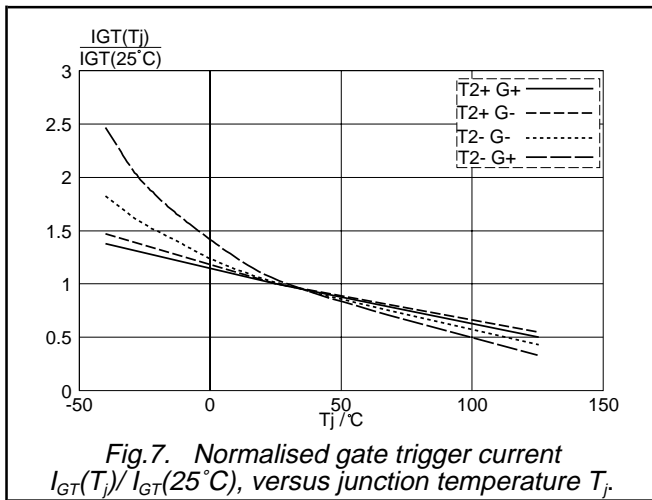

Fig.6. Normalised gate trigger voltage $V_{GT}(T_j)/V_{GT}(25^\circ C)$, versus junction temperature T_j .

Triacs

BT137X series



Triacs

BT137X series

MECHANICAL DATA

Dimensions in mm

Net Mass: 2 g

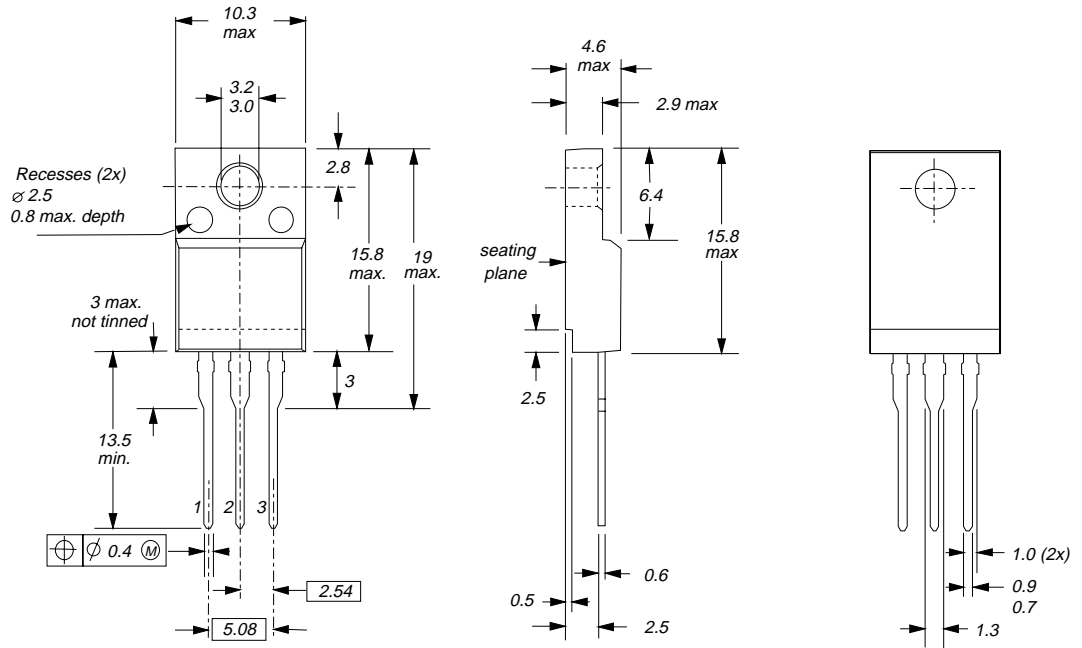

Fig. 13. SOT186A; The seating plane is electrically isolated from all terminals.

Notes

1. Refer to mounting instructions for F-pack envelopes.
2. Epoxy meets UL94 V0 at 1/8".

Triacs

BT137X series

DEFINITIONS

Data sheet status	
Objective specification	This data sheet contains target or goal specifications for product development.
Preliminary specification	This data sheet contains preliminary data; supplementary data may be published later.
Product specification	This data sheet contains final product specifications.
Limiting values	
Limiting values are given in accordance with the Absolute Maximum Rating System (IEC 134). Stress above one or more of the limiting values may cause permanent damage to the device. These are stress ratings only and operation of the device at these or at any other conditions above those given in the Characteristics sections of this specification is not implied. Exposure to limiting values for extended periods may affect device reliability.	
Application information	
Where application information is given, it is advisory and does not form part of the specification.	
© Philips Electronics N.V. 1997	
All rights are reserved. Reproduction in whole or in part is prohibited without the prior written consent of the copyright owner.	
The information presented in this document does not form part of any quotation or contract, it is believed to be accurate and reliable and may be changed without notice. No liability will be accepted by the publisher for any consequence of its use. Publication thereof does not convey nor imply any license under patent or other industrial or intellectual property rights.	

LIFE SUPPORT APPLICATIONS

These products are not designed for use in life support appliances, devices or systems where malfunction of these products can be reasonably expected to result in personal injury. Philips customers using or selling these products for use in such applications do so at their own risk and agree to fully indemnify Philips for any damages resulting from such improper use or sale.



LittleDiode supplies new, hard to find or obsolete electronic components and semiconductors all over the world.

With over two million different components listed you are sure to find the part you need.

Feel free to visit us today at our online store:

LittleDiode.com

Looking forward to providing you with the best possible service.